

DAIKIN



INSTALLATION MANUAL

VRV II System air conditioner

REYQ8M8W1B
REYQ10M8W1B
REYQ12M8W1B
REYQ14M8W1B
REYQ16M8W1B

REYQ18M
REYQ20M
REYQ22M
REYQ24M
REYQ26M
REYQ28M
REYQ30M
REYQ32M
REYQ34M
REYQ36M
REYQ38M
REYQ40M
REYQ42M
REYQ44M
REYQ46M
REYQ48M

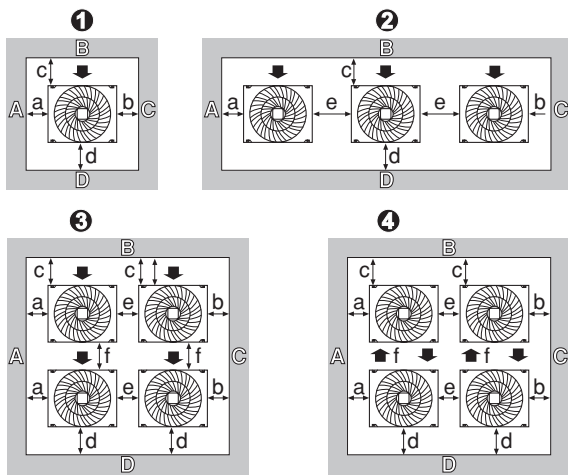

	①	②	③	④
A+B+C+D	I)*	$c \geq 300 \text{ mm}$	$a \geq 10 \text{ mm}$ $b \geq 10 \text{ mm}$ $d \geq 500 \text{ mm}$	$c \geq 500 \text{ mm}$ $a \geq 10 \text{ mm}$ $b \geq 10 \text{ mm}$ $d \geq 500 \text{ mm}$
			$e \geq 20 \text{ mm}$	$f \geq 600 \text{ mm}$ $f \geq 900 \text{ mm}$
A+B	II)*	$c \geq 100 \text{ mm}$	$a \geq 50 \text{ mm}$ $b \geq 50 \text{ mm}$ $d \geq 500 \text{ mm}$	$c \geq 500 \text{ mm}$ $a \geq 50 \text{ mm}$ $b \geq 50 \text{ mm}$ $d \geq 500 \text{ mm}$
			$e \geq 100 \text{ mm}$	$f \geq 500 \text{ mm}$ $f \geq 600 \text{ mm}$
	III)	$a \geq 200 \text{ mm}$ $c \geq 300 \text{ mm}$		
		$e \geq 400 \text{ mm}$		

* $H > 1500 \text{ mm} \Rightarrow d \geq d + (h_2/2)$
 $h > 500 \text{ mm} \Rightarrow c \geq c + (h_1/2)$

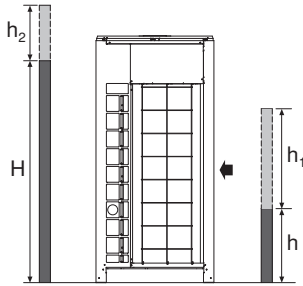

1

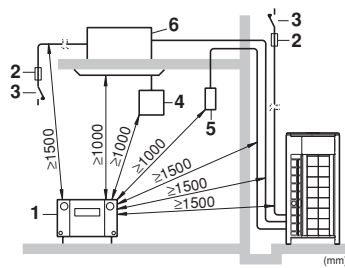

2

REYQ8+10

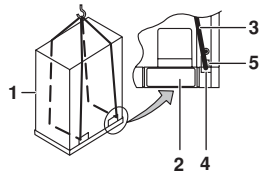

3

REYQ12-16

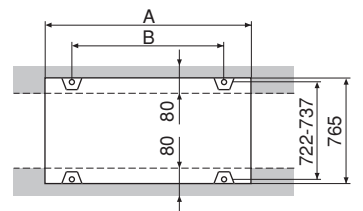
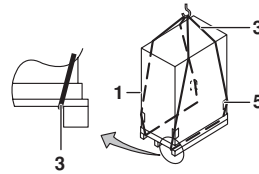

4

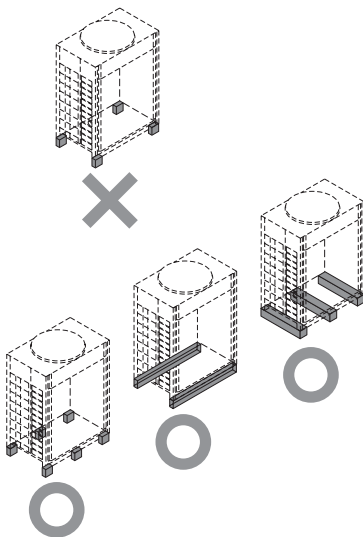

6

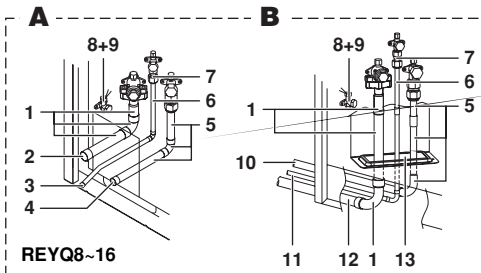

5

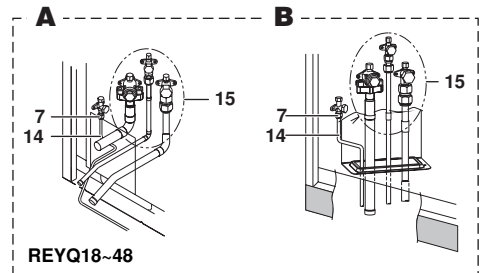

8

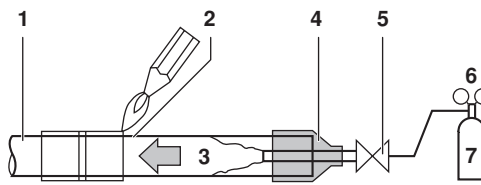

7

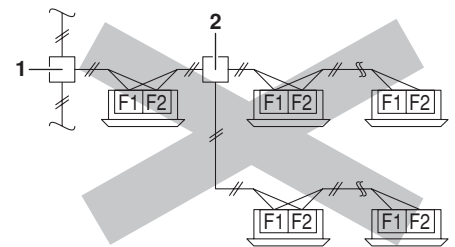

8

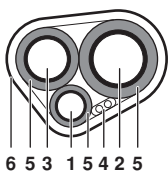

9

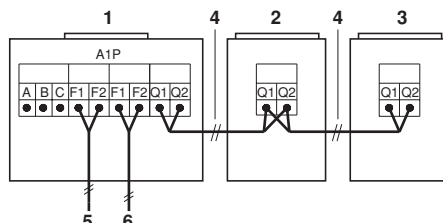

10

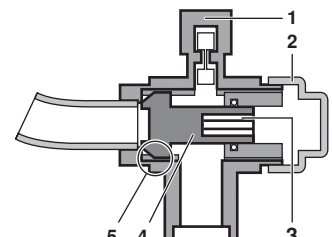

11

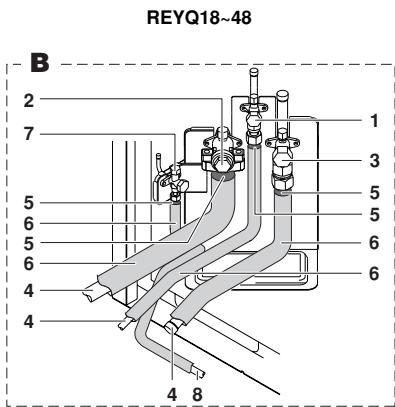
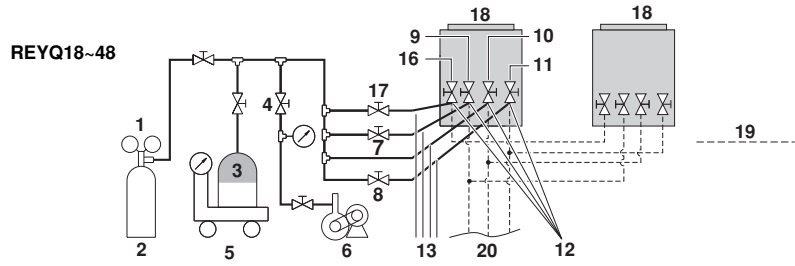
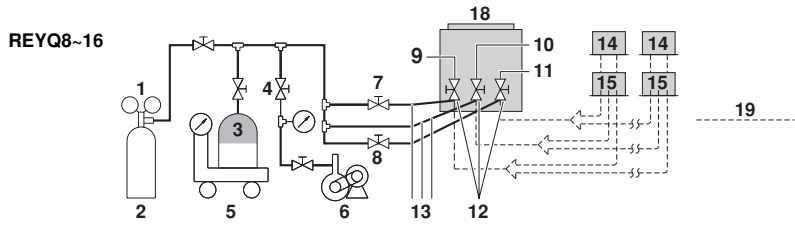
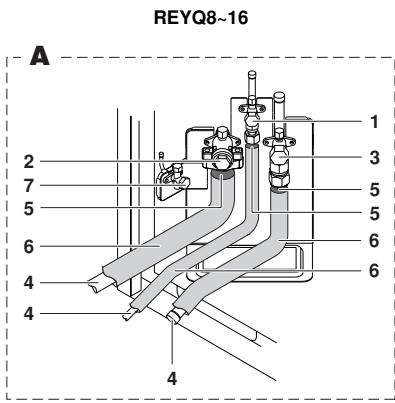

12

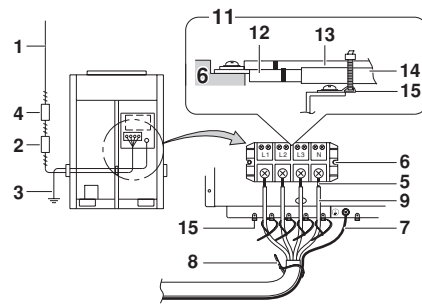

14

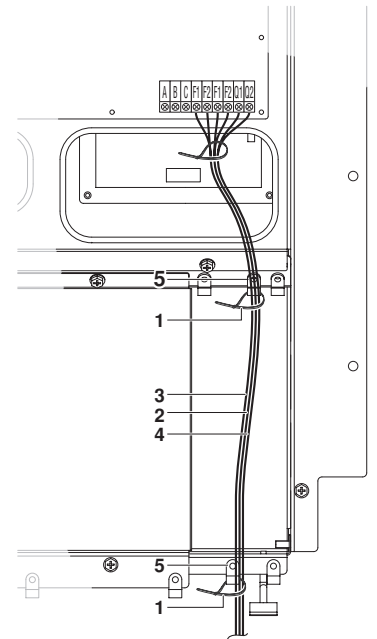

13

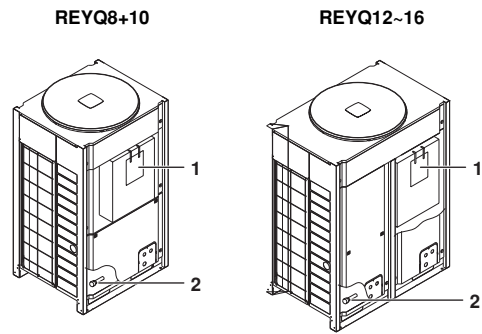

15

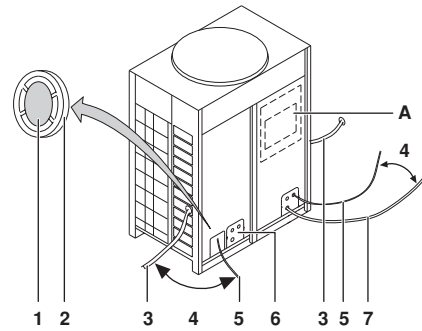

16

17

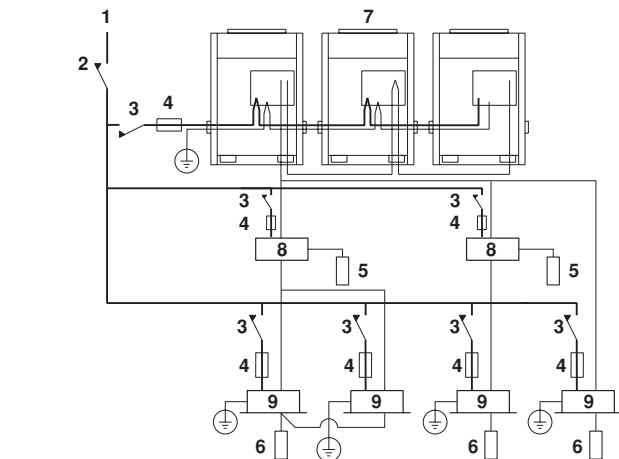

18

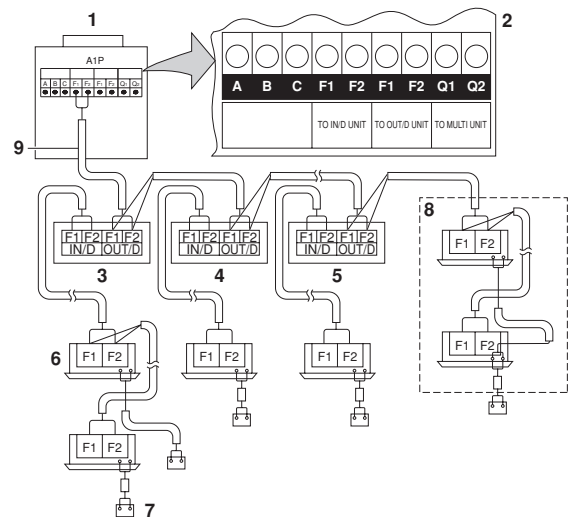

19

REYQ8+10

REYQ12~16

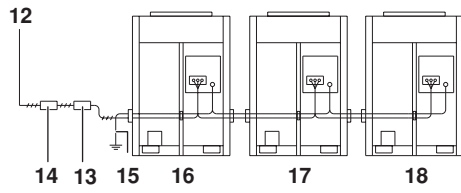
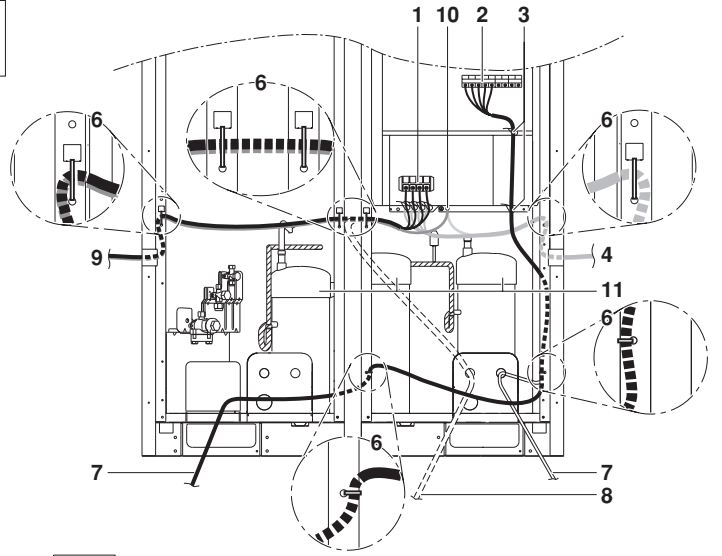
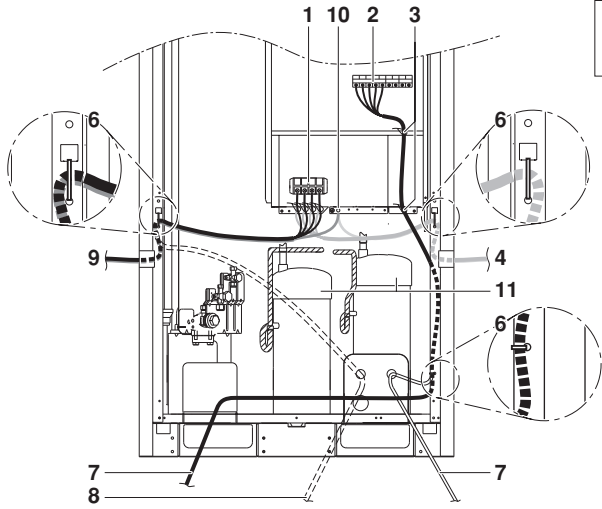

NOTES



CE - DECLARATION-OF-COMFORMITY
CE - KONFORMITÄTSEKHLARUNG
CE - DECLARATION-DE-CONFORMITE
CE - KONFORMITEITSVERKLARING

Daikin Europe N.V.

- 01 declares under its sole responsibility that the air conditioning models to which this declaration relates;
- 02 erklärt auf seine alleinige Verantwortung daß die Modelle der Klimaanlage für die diese Erklärung bestimmt ist;
- 03 déclare sous sa seule responsabilité que les appareils (air conditionné) visés par la présente déclaration;
- 04 verklaart hierop op eigen exclusieve verantwoordelijkheid dat de airconditioning units waarop deze verklaring betrekking heeft;
- 05 declara bajo su única responsabilidad que los modelos de aire acondicionado a los cuales hace referencia la declaración;
- 06 dichiara sotto sua responsabilità che i condizionatori modello a cui è riferita questa dichiarazione;
- 07 δηλώνει με αποκλειστική της ευθύνη ότι το προϊόντα των κλιματιστικών οποιωνδήποτε ονόματων που αναφέρονται στο παρόν έγγραφο;
- 08 declara sob sua exclusiva responsabilidade que os modelos de ar condicionado a que esta declaração se refere;
- 09 заявляет, исключительно под своей ответственностью, что модели кондиционеров воздуха, к которым отнoсится настоящее заявление;

REYQ8M8W1B, REYQ10M8W1B, REYQ12M8W1B, REYQ14M8W1B, REYQ16M8W1B

01 are in conformity with the following standard(s) or other normative document(s), provided that these are used in accordance with our instructions:

- 02 der/den folgenden Norm(en) oder einen anderen Normdokument oder -dokumenten entspricht/sprechen, unter der Voraussetzung, daß sie gemäß unseren Anweisungen eingesetzt werden;
 - 03 sont conformes à laux norm(s) ou autre(s) document(s) normatif(s), pour autant qu'ils soient utilisés conformément à nos instructions;
 - 04 conform de volgende norm(en) of één of meer andere bindende documenten zijn, op voorwaarde dat ze worden gebruikt overeenkomstig onze instructies;
 - 05 están en conformidad con la(s) siguiente(s) norma(s) u otro(s) documento(s) normativo(s), siempre que sean utilizados de acuerdo con nuestras instrucciones;
 - 06 sono conformi agli seguente(s) standard(s) o altro(i) documento(i) a carattere normativo, a patto che vengano usati in conformità alle nostre istruzioni;
 - 07 эти устройства не только соответствуют (и/или соответствуют) требованиям, указанным в инструкциях, но и соответствуют следующим требованиям:
- EN60335-2-40,
- 01 following the provisions of;
 - 02 gemäß den Vorschriften der;
 - 03 conformen aan stipulaties des;
 - 04 overeenkomstig de bepalingen van;
 - 05 siguiendo las disposiciones de;
 - 06 secondo le prescrizioni per;
 - 07 по условиям тех. задат.еван. тов.;
 - 08 de acordo com o previsto em;
 - 09 в соответствии с положениями.

- 01* as set out in the Technical Construction File and judged positively by according to the Certificate .
- ** as set out in the Technical Construction File and judged positively by Applied module .
- 02** via in der Technischen Konstruktionsakte aufgeführt und von positiv ausgerechnet gemäß Certificate .
- ** via in der Technischen Konstruktionsakte aufgeführt und von (Angewandtes Modul) positiv ausgerechnet gemäß .
- 03** le que s'applique dans le Fichier de Construction Technique et jugé positivement par conformément au Certificate .
- ** le que s'applique dans le Fichier de Construction Technique et jugé positivement par (Module appliqué).
- 04** zaas vermeld in het Technische Constructiedossier en in orde bevonden door overeenkomstig Certificate .
- ** zaas vermeld in het Technische Constructiedossier en in orde bevonden door (Apparaatmodule).
- 05** al com o nome e el Modelo de Construção Técnica e julgado positivamente por según el Certificate .
- ** al como el Modelo de Construção Técnica e julgado positivamente por (Módulo aplicado).

CE - DECLARAÇÃO-DE-CONFORMIDADE
CE - ЗАЯВЛЕНИЕ-О-СООТВЕТСТВИИ
CE - DECLARAȚIE-DE-CONFORMITATE
CE - FORSKRÄN-OM-ÖVERENSTÄMMELSE

- 10 erklärer under eneansvar, at klimaanlægsmødelerne, som denne deklaration vedrører;
- 11 déclarent responsabilité de la climatisation, que les modèles de climatisation mentionnés dans cette déclaration ont été conçus et fabriqués conformément aux spécifications techniques indiquées dans le dossier technique et jugés positivement par conformément au Certificat .
- 12 erklärt auf seine alleinige Verantwortung, dass die Klimatisierungsmodelle, die in dieser Deklaration genannt sind, nach den technischen Zeichnungen entworfen und hergestellt wurden und von positiv ausgerechnet wurden, gemäß dem Zertifikat .
- 13 ilmoittaa yksinomaan omalla vastuullaan, että tämän ilmoituksen taustalla olleiden mallien tekniset tiedot on esitetty ja mallit on todettu täysin vastaavan teknisiä vaatimuksia ja mallit on todettu täysin vastaavan teknisiä vaatimuksia .
- 14 prohláší ve své plné odpovědnosti, že modely klimatizace, k nimž se toto prohlášení vztahuje;
- 15 izjavlja pod izključivo vlastitom odgovornostjo, da su modeli klima uređaja na koje se ova izjava odnosi;
- 16 teljes felelősséggel tudatában kijelenti, hogy az klimatizációs modellek, melyekre e nyilatkozat vonatkozik;
- 17 deklaruje na własną odpowiedzialność, że modele klimatyzatorów, których dotyczy niniejsza deklaracja;
- 18 deklará pe proprie răspundere că aparatele de aer condiționat la care se referă această declarație;

08 estão em conformidade com a(s) seguinte(s) norma(s) ou outro(s) documento(s) normativo(s), desde que estes sejam utilizados de acordo com as nossas instruções;- 09 соответствуют следующим стандартам или другим нормативным документам, при условии их использования согласно нашим инструкциям;
- 10 overholder følgende standard(er) eller andet/andre retningsreguleringe dokument(er), bundsat at disse anvendes i henhold til vore instrukser;
- 11 respectue utstilling är utförd i överensstämmelse med och följer följande standard(er) eller andra normgivande dokument, under förutsättning att användning sker i överensstämmelse med våra instruktioner;
- 12 respectue uslyer eri overensstemmelse med følgende standard(er) eller andre normgivende dokument(er), under forudsætning at disse bruges i henhold til vore instrukser;
- 13 nastava, sauzaņemot standartāri ja mūdien objeiktstien dokumentien vaaimuksa edelīstien, eti niti jāveidāt atpeldēme mūkstestē;
- 14 za preopkladu, že jsou vyznačeny v souladu s našimi pokyny, odpovídají následujícím normám nebo normativním dokumentům;
- 15 u skladu sa slijedećim standardom(i)ma) ili drugim normativnim dokumentom(i)ma), uz uvjet da se oni koriste u skladu s našim uputama;

Low Voltage 73/23/EEC
Machinery Safety 99/37/EEC
Electromagnetic Compatibility 89/336/EEC *
Pressure Equipment 97/23/EEC **

- 16* a)Z mőszaki konstrukciós dokumentáció alapján, a)Z igazolta a megfelelőséget a)Z tanúsítvány szerinti.
- ** a)Z mőszaki konstrukciós dokumentáció alapján, a)Z igazolta a megfelelőséget a)Z (Tanúsítvány alapján) .
- 17* zgodnie z archiwalną dokumentacją konstrukcyjną pozytywną opinią Świadectwem .
- ** zgodnie z archiwalną dokumentacją konstrukcyjną pozytywną opinią (Zaświadczenie) .
- 18* conformément à la norme technique de construction et agréée par le service technique de construction .
- ** conformément à la norme technique de construction et agréée par le service technique de construction .
- 19* koji je obdobje i tehnički mepi u obdobju s strani skladu s certifikatom .
- ** koji je obdobje i tehnički mepi u obdobju s strani (Upravljen moduli).
- 20* neu on naitadun tehnikes dokumentatsioins ja heaks kiidatud järgi testatud sertifikaadile .
- ** neu on naitadun tehnikes dokumentatsioins ja heaks kiidatud järgi testatud sertifikaadile .
- ** kako je obdobje i tehnički konstrukcij u pozitivno ocijenjeno od strane (Priljepljeni moduli).

CE - IZJAVA-O-USKLADNOSTI
CE - MEGFELELŐSÉG-NYILATKOZAT
CE - DEKLARACIJA-ZGODNOSTI
CE - DECLARAȚIE-DE-CONFORMITATE

- 19** z no odgovornosti izjavlja, da so modeli klimatskih naprav, na katere se izjava nanaša;
- 20** kimlata, oma täieliku vastutuse, et käesoleva deklaratsiooni alla kuuluvad kliimaseadmede mudelid;
- 21** deklaram na svoj odgovornost, že modelite klimatizacijske inštalacije, za katere se otačaja taži deklaracija;
- 22** visikše savo atsakomybę atelbia, kad oro kondicionavimo priđabų modeliai, kuriems yra taikoma šis deklaracija;
- 23** ar plniu atbildnu aplienca, ke také vzsklato modely gaska kondicicijeli, uz kurim atelias šis deklaracija;
- 24** vyhlasuje na vlastnu zodpovednost, že tieto klimatizačné modely, na ktoré sa vzťahuje toto vyhlásenie;
- 25** izjavam, kerndi sorumlujománda otnak izjave bu bitirirni ligiti odobru klima modelerini spagidati gbi odobruju beyan eder;

16 megfelelőnek az alábbi szabvány(ok)/nak vagy egyéb irányadó dokumentum(ok)/nak, ha azokat előírás szerinti használatjuk;- 17 megfelel a következő követelőzők norm /llym dokumentok normalizációjnak, pod vaenikien že uzlyvane sa zgodnie z našimi inštrukcijami;
- 18 sunt în conformitate cu următorul (următoarele) standard(e) sau, al(e) document(e) normativ(e), cu condiția ca acestea să fie utilizate în conformitate cu instrucțiunile noastre;
- 19 skladu z naslednjimi standardi in drugimi normami, abtli sekopštem standardiem in citiem normativim dokumentim;
- 20 on vastuses järgmistele standarditele, võti teiselt normatiivsetele dokumentidele, kui need kasutatakse vastavalt meie juhendile;
- 21 съответства на следните стандарти или други нормативни документи, при условие, че се използват съгласно нашите инструкции;
- 22 atliksa zēmaunurobylus standartus ir (arba) klus normiuis dokumentus su saļgā, kad ya naudojami pagal mūsā nurobyumus;
- 23 ad, ja liekli atbilstošā razdāja norādījumam, abtli sekopštem standartiem un citiem normatīviem dokumentiem;
- 24 su vzhode s naslednjimi normami) abo inimi) normativnimi) dokumentom(i)ma), za predpokrtda, že sa poživajajo v skladu s našimi navodmi;
- 25 urunin, ialmatlarına göre kullanılması koşullarına aşağıdaki standartlar ve norm belgileri uygundur;

- 01 Directives, als amended;
- 11 Direktiv, med senere ændringer;
- 12 Direktiv, med förändring ändringar;
- 13 Direktiv, med förändring ändringar;
- 14 Richtlijnen, zoals gearmderd;
- 15 Directives, según lo emendado;
- 16 řadyvelek) és módosítások rendelkezéseit;
- 17 z późniejszych poprawkami;
- 18 Directivel, cu amendamentele respective;
- 19 Direktive z vsemi spremembami;
- 20 Direktivdi kos mudatistega;
- 21 Директиви, с текове изменения;
- 22 Direktive su paplytinėjus;
- 23 Direktivās un to papildinājums;
- 24 Smernice, koje je izmijenjeno;
- 25 Dėgstinimš šaleryje Yonetmeliker;

<A>	DAIKIN.TCF.022
	TNO
<C>	0305020101
<D>	Daikin.TCFP.001
<E>	AIB Vnçoite (NB0026)
<F>	D1
<G>	—

- 21* karto e zatoveno v Akta za tehnička konstrukcija v celotno normalno or oznako Certificate .
- ** karto e zatoveno v Akta za tehnička konstrukcija v celotno normalno or (Tanusitvayn) .
- 22* yapı nurobyla tehničke konstruktioyas bylye ir patvirima pagal pažymėjima .
- ** yapı nurobyla tehničke konstruktioyas bylye ir patvirima (tekoms modul).
- 23** la norkas tehniska dokumentatsioins atbilstis pozitivam lēmumam, ko pieņemta sertifikats .
- ** la norkas tehniska dokumentatsioins atbilstis pozitivam lēmumam, ko pieņemta sertifikats .
- 24** ako je ustanoveno v Subore tehničke konstrukcije a klaine posidēne podľa Certificate .
- ** ako je ustanoveno v Subore tehničke konstrukcije a klaine posidēne (Apilkojamy moduli).
- 25** Tehnik Yap Dusyasadna beritidgi gbi ve sertifikasna gāp padindan omni darak (pāgāpārdinimšji).
- ** Tehnik Yap Dusyasadna beritidgi gbi ve padindan omni darak (Upravljen moduli).



CONTENTS

	Page
1. Introduction.....	1
1.1. Combination.....	2
1.2. Standard supplied accessories.....	2
1.3. Optional accessories.....	2
1.4. Technical and electrical specifications.....	2
2. Main components.....	2
3. Selection of location.....	2
4. Inspecting and handling the unit.....	3
5. Unpacking and placing the unit.....	3
6. Refrigerant piping.....	4
6.1. Selection of piping material.....	4
6.2. Connecting the refrigerant piping.....	4
6.3. Example of connection.....	7
6.4. Leak test and vacuum drying.....	9
6.5. Pipe insulation.....	10
6.6. Additional refrigerant charge.....	10
7. Field wiring.....	11
7.1. Internal wiring - Parts table.....	11
7.2. Power circuit and cable requirements.....	12
7.3. General.....	12
7.4. Examples.....	13
8. Before operation.....	16
8.1. Service precautions.....	16
8.2. Checks before initial start-up.....	16
8.3. Field setting.....	16
8.4. Test operation.....	18
9. Service mode operation.....	19
10. Caution for refrigerant leaks.....	20
11. Disposal requirements.....	20



The refrigerant R-410A requires strict cautions for keeping the system clean, dry and tight.

- Clean and dry
Foreign materials (including mineral oils such as SUNISO oil or moisture) should be prevented from getting mixed into the system.
- Tight
R-410A does not contain any chlorine, does not destroy the ozone layer, and does not reduce the earth's protection against harmful ultraviolet radiation. R-410A can contribute slightly to the greenhouse effect if it is released. Therefore we should take special attention to check the tightness of the installation.

Read "6. Refrigerant piping" on page 4 carefully and follow these procedures correctly.



Since design pressure is 3.8 MPa or 38 bar (for R-407C units: 3.3 MPa or 33 bar), pipes of larger wall thickness may be required. Refer to paragraph "6.1. Selection of piping material" on page 4.

1. INTRODUCTION

This installation manual concerns VRV inverters of the Daikin REYQ-M series. These units are designed for outdoor installation and used for cooling and heatpump applications. The REYQ-M-series can be combined from 5 main units and has nominal cooling capacities ranging from 22.4 to 134 kW and nominal heating capacities ranging from 25.0 to 150 kW.

The REYQ-M units can be combined with Daikin VRV indoor units for air conditioning purposes, and suitable for R-410A.

The present installation manual describes the procedures for unpacking, installing and connecting the REYQ-M units. Installation of the indoor units is not described in this manual. Always refer to the installation manual supplied with these units for their installation.



READ THIS MANUAL ATTENTIVELY BEFORE STARTING UP THE UNIT. DO NOT THROW IT AWAY. KEEP IT IN YOUR FILES FOR FUTURE REFERENCE.

IMPROPER INSTALLATION OR ATTACHMENT OF EQUIPMENT OR ACCESSORIES COULD RESULT IN ELECTRIC SHOCK, SHORT-CIRCUIT, LEAKS, FIRE OR OTHER DAMAGE TO THE EQUIPMENT. BE SURE ONLY TO USE ACCESSORIES MADE BY DAIKIN WHICH ARE SPECIFICALLY DESIGNED FOR USE WITH THE EQUIPMENT AND HAVE THEM INSTALLED BY A PROFESSIONAL.

DAIKIN EQUIPMENT IS DESIGNED FOR COMFORT APPLICATIONS. FOR USE IN OTHER APPLICATIONS, PLEASE CONTACT YOUR LOCAL DAIKIN DEALER.

IF UNSURE OF INSTALLATION PROCEDURES OR USE, ALWAYS CONTACT YOUR DEALER FOR ADVICE AND INFORMATION.

1.1. Combination







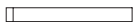

The indoor units can be installed in the following range.

- Always use appropriate indoor units compatible with R-410A. To learn which models of indoor units are compatible with R-410A, refer to the product catalogs.
- Total capacity/quantity of indoor units

Outdoor unit		Total capacity of indoor units	Total quantity of indoor units
REYQ8	(*)	100~260	13
REYQ10	(*)	125~325	16
REYQ12	(*)	150~390	19
REYQ14	(*)	175~455	20
REYQ16	(*)	200~520	20
REYQ18		225~585	20
REYQ20		250~650	20
REYQ22		275~715	22
REYQ24		300~780	32
REYQ26		325~845	32
REYQ28		350~910	32
REYQ30		375~975	32
REYQ32		400~1040	32
REYQ34		425~1105	34
REYQ36		450~1170	36
REYQ38		475~1235	38
REYQ40		500~1300	40
REYQ42		525~1365	40
REYQ44		550~1430	40
REYQ46		575~1495	40
REYQ48		600~1560	40

(*) = main units

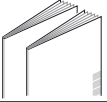
1.2. Standard supplied accessories

Suction gas line piping (1)	1	
Suction gas line piping (2)	1	
Suction gas line piping (3)	1	
Discharge gas line piping (1)	1	 REYQ8  REYQ10+12  REYQ14+16
Discharge gas line piping (2)	1	
Discharge gas line piping (3)	1	
Installation manual	1	
Operation manual	1	
Additional refrigerant charge label	1	

Refer to figure 15.

- Installation and operational manual
- Accessory pipes

1.3. Optional accessories

To install the above outdoor units, the following optional parts are also required.

- Refrigerant branching kit (for R-410A only: Always use an appropriate kit dedicated for your system.)

For 3 pipes:

Refnet header	Refnet joint
—	KHRQ23M20T
KHRQ23M29H	KHRQ23M29T
KHRQ23M64H	KHRQ23M64T
KHRQ23M75H	KHRQ23M75T

For 2 pipes:

Refnet header	Refnet joint
—	KHRQ22M20T
KHRQ22M29H	KHRQ22M29T
KHRQ22M64H	KHRQ22M64T

- Outdoor unit multi connection piping kit (For R-410A only: Always use an appropriate kit dedicated for your system.)

Number of outdoor units connected	
2	3
BHFQ23M907	BHFQ23M1357

To select an optimum refrigerant branching kit, refer to "6. Refrigerant piping" on page 4.

1.4. Technical and electrical specifications

Refer to the Engineering Data Book for the complete list of specifications.

2. MAIN COMPONENTS

For main components and function of the main components, refer to the Engineering Data Book.

3. SELECTION OF LOCATION

This is a class A product. In a domestic environment this product may cause radio interference in which case the user may be required to take adequate measures.



- Make sure to provide for adequate measures in order to prevent that the outdoor unit be used as a shelter by small animals.
- Small animals making contact with electrical parts can cause malfunctions, smoke or fire. Please instruct the customer to keep the area around the unit clean.

The inverter units should be installed in a location that meets the following requirements:

- The foundation is strong enough to support the weight of the unit and the floor is flat to prevent vibration and noise generation.
- The space around the unit is adequate for servicing and the minimum space for air inlet and air outlet is available. (Refer to figure 1 and choose one of the possibilities).

In case of an installation site where only the sides A+B have obstacles, the wall heights have no influence on any indicated service space dimensions.

- A B C D Sides along the installation site with obstacles
- ➡ Suction side

- 3 There is no danger of fire due to leakage of inflammable gas.
- 4 Ensure that water cannot cause any damage to the location in case it drips out the unit (e.g. in case of a blocked drain pipe).
- 5 The piping length between the outdoor unit and the indoor unit may not exceed the allowable piping length. (Refer to "6.3. Example of connection" on page 7)
- 6 Select the location of the unit in such a way that neither the discharged air nor the sound generated by the unit disturb anyone.
- 7 Make sure that the air inlet and outlet of the unit are not positioned towards the main wind direction. Frontal wind will disturb the operation of the unit. If necessary, use a windscreen to block the wind.
- 8 Do not install or operate the unit on locations where air contains high levels of salt, like e.g. in the vicinity of oceans. (Refer for further information to the engineering databook).



- The equipment described in this manual may cause electronic noise generated from radio-frequency energy. The equipment complies to specifications that are designed to provide reasonable protection against such interference. However, there is no guarantee that interference will not occur in a particular installation. It is therefore recommended to install the equipment and electric wires keeping proper distances away from stereo equipment, personal computers, etc... (See figure 2).

- 1 Personal computer or radio
- 2 Fuse
- 3 Earth leak detector
- 4 Remote controller
- 5 Cool/heat selector
- 6 Indoor unit



In extreme circumstances you should keep distances of 3 m or more and use conduit tubes for power and transmission lines.

- In heavy snowfall areas, select an installation site where snow will not affect operation of the unit.
- The refrigerant R-410A itself is nontoxic, nonflammable and is safe. If the refrigerant should leak however, its concentration may exceed the allowable limit depending on room size. Due to this it could be necessary to take measures against leakage. Refer to the chapter "10. Caution for refrigerant leaks" on page 20.
- Do not install in the following locations.
 - Locations where sulfurous acids and other corrosive gases may be present in the atmosphere. Copper piping and soldered joints may corrode, causing refrigerant to leak.
 - Locations where equipment that produces electromagnetic waves is found. The electromagnetic waves may cause the control system to malfunction, preventing normal operation.
 - Locations where flammable gases may leak, where thinner, gasoline, and other volatile substances are handled, or where carbon dust and other incendiary substances are found in the atmosphere. Leaked gas may accumulate around the unit, causing an explosion.

4. INSPECTING AND HANDLING THE UNIT

At delivery, the package should be checked and any damage should be reported immediately to the carrier claims agent.

When handling the unit, take into account the following:

- 1  Fragile, handle the unit with care.
- 2  Keep the unit upright in order to avoid compressor damage.
- 3 Choose in advance the path along which the unit is to be brought in.
- 4 Lift the unit preferably with a crane and 2 belts of at least 8 m long.
- 5 When lifting the unit with a crane, always use protectors to prevent belt damage and pay attention to the position of the unit's centre of gravity.
- 6 Bring the unit as close to its final installation position in its original package to prevent damage during transport. (See figure 3)
 - 1 Packaging material
 - 2 Opening (large)
 - 3 Belt sling
 - 4 Opening (small)(40x30)
 - 5 Protector

5. UNPACKING AND PLACING THE UNIT

- Remove the four screws fixing the unit to the pallet.
- Make sure the unit is installed level on a sufficiently strong base to prevent vibration and noise.
- Fasten the unit in place using four anchor bolts M12.
- Make sure the base under the unit is extended more than 765 mm behind the unit.
- The unit must be installed on a solid longitudinal foundation (steelbeam frame or concrete) as indicated in figure 4.

Model	A	B
REYQ8+10	930	792
REYQ12~16	1240	1102



Do not use stands to support the corners. (See figure 6)

- X Not allowed
- O Allowed



- Prepare a water drainage channel around the foundation to drain waste water from around the unit.
- If the unit is to be installed on a roof, check the strength of the roof and its drainage facilities first.
- If the unit is to be installed on a frame, install the waterproofing board within a distance of 150 mm under the unit in order to prevent infiltration of water coming from under the unit.

PRECAUTION

Block all gaps in the holes for passing out piping and wiring using sealing material (field supply). (Small animals may enter the machine.)

Example: passing piping out through the front

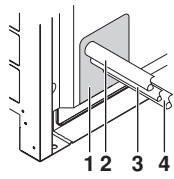

- 1 Plug the areas marked with "X".
(When the piping is routed from the front panel.)
- 2 Suction gas side piping
- 3 Liquid side piping
- 4 Discharge gas side piping

6. REFRIGERANT PIPING



Use R-410A to add refrigerant.

All field piping must be installed by a licensed refrigeration technician and must comply with relevant local and national regulations.

CAUTION TO BE TAKEN WHEN BRAZING REFRIGERANT PIPING

Do not use flux when brazing copper-to-copper refrigerant piping. (Particularly for the HFC refrigerant piping) Therefore, use the phosphor copper brazing filler metal (BCuP) which does not require flux.

Flux has extremely harmful influence on refrigerant piping systems. For instance, if the chlorine based flux is used, it will cause pipe corrosion or, in particular, if the flux contains fluorine, it will damage the refrigerant oil.

Be sure to perform a nitrogen blow when brazing. (Brazing without performing nitrogen replacement or releasing nitrogen into the piping will create large quantities of oxidized film on the inside of the pipes, adversely affecting valves and compressors in the refrigerating system and preventing normal operation.)

NOTE

Installation tools:



Make sure to use installation tools (gauge manifold charge hose, etc.) that are exclusively used for R-410A installations to withstand the pressure and to prevent foreign materials (e.g. mineral oils such as SUNISO and moisture) from mixing into the system. (The screw specifications differ for R-410A and R-407C.)

Vacuum pump (use a 2-stage vacuum pump with a non-return valve):

- Make sure the pump oil does not flow oppositely into the system while the pump is not working.

6.1. Selection of piping material

1. Foreign materials inside pipes (including oils for fabrication) must be 30 mg/10 m or less.
2. Use the following material specification for refrigerant piping:
 - Size: determine the proper size referring to chapter "6.3. Example of connection" on page 7.
 - Construction material: phosphoric acid deoxidized seamless copper for refrigerant.
 - Temper grade: use piping with temper grade in function of the pipe diameter as listed in below table.

Pipe Ø	Temper grade of piping material
≤15.9	O
≥19.1	1/2H

O = Annealed
1/2H = Half hard

- The pipe thickness of the refrigerant piping should comply with relevant local and national regulations. The minimal pipe thickness for R-410A piping must be in accordance with the table below.

Pipe Ø	Minimal thickness t (mm)
6.4	0.80
9.5	0.80
12.7	0.80
15.9	0.99
19.1	0.80

Pipe Ø	Minimal thickness t (mm)
22.2	0.80
28.6	0.99
34.9	1.21
41.3	1.43

3. Make sure to use the particular branches of piping that have been selected referring to chapter "6.3. Example of connection" on page 7.
4. In case the required pipe sizes (inch sizes) are not available, it is also allowed to use other diameters (mm sizes), taken the following into account:
 - select the pipe size nearest to the required size.
 - use the suitable adapters for the change-over from inch to mm pipes (field supply).

6.2. Connecting the refrigerant piping

- 1 Installation of refrigerant piping is possible as front connection or side connection (when taken out from the bottom) as shown in the figure.

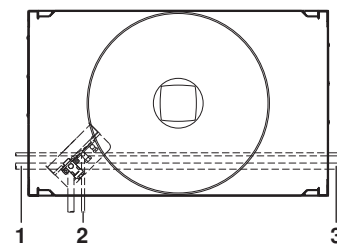

- 1 Left-side connection
- 2 Front connection
- 3 Right-side connection

One outdoor unit installed: In case of REYQ8~16

- Front connection:
Remove the stop valve cover to connect. (See figure 5)
 - Side (bottom) connection:
Remove the knock holes on the bottom frame and route the piping under the bottom frame. (See figure 5)
- A** Front connection:
Remove the stop valve cover to connect.
- B** Side (bottom) connection:
Remove the knock holes on the bottom frame and route the piping under the bottom frame
- 1 Suction gas side accessory pipe (1)(2)(3)
 - 2 Suction gas line
 - 3 Liquid gas line
 - 4 Discharge gas line
 - 5 Discharge gas side accessory pipe (1)(2)(3)
 - 6 Liquid side piping (field supply)
 - 7 Flare nut
 - 8 Oil-equalizing piping stop valve
 - 9 No piping work is needed
 - 10 Discharge gas piping (field supply)
 - 11 Liquid gas piping (field supply)
 - 12 Suction gas piping (field supply)
 - 13 Knockout hole
Punch the knock holes.
 - 14 Oil-equalizing piping (field supply)
 - 15 Same legend as for REYQ8~16 in figure 5.

When multiple outdoor units are installed: In case of REYQ18~48

To connect the piping between outdoor units, an optional piping kit (multi connection piping kit) is always required. When installing the piping, follow the instructions in the installation manual that comes with the kit.

- Front connection:
Remove the stop valve cover to connect. (See figure 5)
- Side (bottom) connection:
Remove the knock holes on the bottom frame and route the piping under the bottom frame. (See figure 5)



- Be sure to use the supplied accessory pipes when carrying out piping work in the field.
- Be sure that the field installed piping does not touch other pipes, the bottom panel or side panel. Especially for the bottom and side connection, be sure to protect the piping with suitable insulation, to prevent it from coming into contact with the casing.

Precautions when knocking out knock holes

- Be sure to avoid damaging the casing.
 - After knocking out the holes, we recommend you paint the edges and areas around the edges using the repair paint to prevent rusting.
 - When passing electrical wiring through the knock holes, wrap the wiring with protective tape to prevent damage.
- 2 Make sure to perform the piping installation within the range of the maximum allowable pipe length, allowable level difference and allowable length after branching as indicated in "6.3. Example of connection" on page 7.
 - 3 For installation of the refrigerant branching kit (Refnet), refer to the installation manual delivered with the kit.
 - 4 Pipe connection
 - Only use the flare nuts included with the unit. Using different flare nuts may cause the refrigerant to leak.



NOTE The pressure regulator for the nitrogen released when doing the brazing should be set to 0.02 MPa or less. (See figure 7)

- 1 Refrigerant piping
- 2 Location to be brazed
- 3 Nitrogen
- 4 Taping
- 5 Manual valve
- 6 Regulator
- 7 Nitrogen

- 5 Protection against contamination when installing pipes
 - Take measures to prevent foreign materials like moisture and contamination from mixing into the system.

	Installation period	Protection method
	More than a month	Pinch the pipe
	Less than a month	
	Regardless of the period	Pinch or tape the pipe

- Great caution is needed when passing copper tubes through walls.

Precautions when selecting branch piping.

If the overall equivalent piping length is ≥ 90 m, be sure to enlarge the main pipe in the liquid-side piping. Do not enlarge the main pipe in the discharge-side and suction-side piping.

[Liquid side]	
REYQ8+10	$\text{Ø}9.5 \rightarrow \text{Ø}12.7$
REYQ12~16	$\text{Ø}12.7 \rightarrow \text{Ø}15.9$
REYQ18~24	$\text{Ø}15.9 \rightarrow \text{Ø}19.1$
REYQ26~48	$\text{Ø}19.1 \rightarrow \text{Ø}22.2$

Cautions for installation of multiple outdoor units

- The piping between the outdoor units must be routed level or slightly upward to avoid the risk of oil detention into the piping side.

Pattern 1

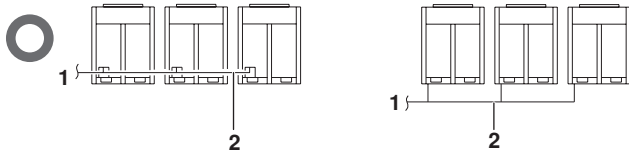

- To indoor unit
- Piping between outdoor units

Pattern 2

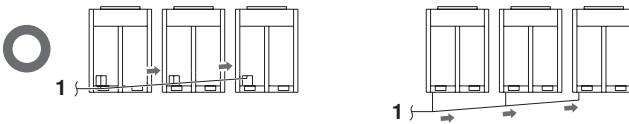

- To indoor unit

Prohibited pattern: Change to Pattern 1 or 2

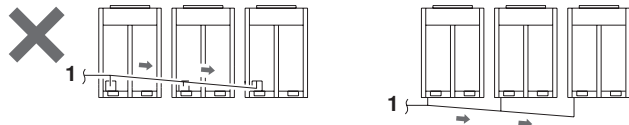

- To indoor unit
- To avoid the risk of oil retention to the stopping unit side, always connect the stop valve and the piping between outdoor units as shown in the figure A or figure B.



Prohibited pattern

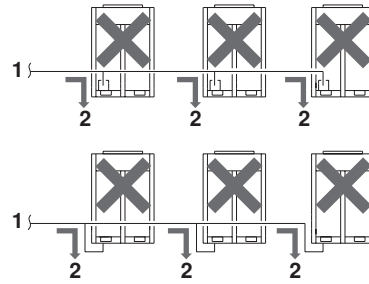

Change to pattern 1 or 2

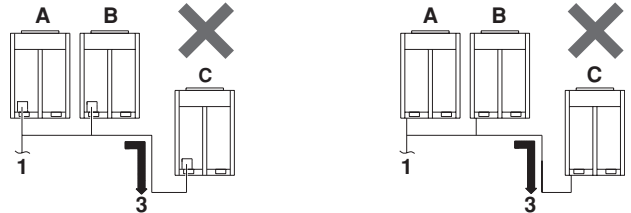

Change as shown in the figure below

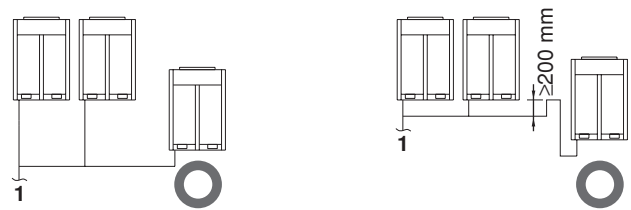

- A Unit A
- B Unit B
- C Unit C
- X Not allowed
- O Allowed

- To indoor unit
- Oil collects to the stopping outdoor unit.
- Oil collects to the outdoor unit C when the system stops.

- If the piping length between the outdoor unit-connecting pipe kits or between the outdoor units exceeds 2 m, create a rise of 200 mm or more in the gas line within a length of 2 m from the kit.

■ If ≤ 2 m

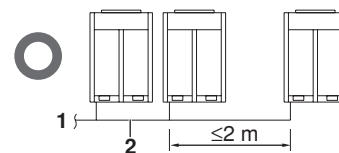

- To indoor unit
- Piping between outdoor units

■ If ≥ 2 m

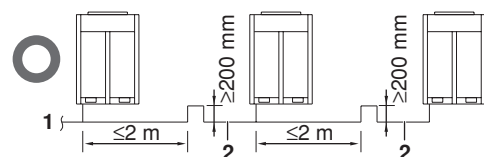
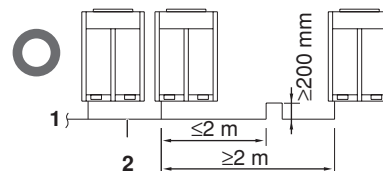

- To indoor unit
- Piping between outdoor units

6.3. Example of connection

		Branch with refnet joint	Branch with refnet joint and refnet header	Branch with refnet header																							
<div style="display: flex; flex-direction: column; align-items: flex-start;"> <div style="display: flex; align-items: center; margin-bottom: 5px;"> 1 indoor unit</div> <div style="display: flex; align-items: center; margin-bottom: 5px;"> B1 BS box</div> <div style="display: flex; align-items: center; margin-bottom: 5px;"> ↙ refnet joint</div> <div style="display: flex; align-items: center; margin-bottom: 5px;"> ↘ refnet header</div> <div style="display: flex; align-items: center; margin-bottom: 5px;"> (3 pipes) 1 2 3</div> <div style="display: flex; align-items: center; margin-bottom: 5px;"> (2 pipes) 4 3</div> <div style="display: flex; align-items: center; margin-bottom: 5px;"> Discharge gas side 1 2 3</div> <div style="display: flex; align-items: center; margin-bottom: 5px;"> Suction gas side 4 3</div> <div style="font-size: 0.8em; margin-bottom: 5px;"> Piping from BS unit to indoor unit and piping from refrigerant branch kit to indoor unit used as cooling only must be composed by 2 pipes (suction gas pipe and liquid pipe). * If the system capacity is REYQ18 or more, measure to the first outdoor branch as seen from the indoor unit. </div> </div>	One outdoor unit installed (REYQ8~16)	<p>1 ~ 6 Cool/heat selection possible 7 + 8 Cooling only</p>	<p>1 ~ 4, 7 + 8 Cool/heat selection possible 5 + 6 Cooling only</p>	<p>1 ~ 6 Cool/heat selection possible 7 + 8 Cooling only</p>																							
	When multiple outdoor units installed (REYQ18~...)	<p>1 ~ 6 Cool/heat selection possible 7 + 8 Cooling only</p>	<p>1 ~ 4, 7 + 8 Cool/heat selection possible 5 + 6 Cooling only</p>	<p>1 ~ 6 Cool/heat selection possible 7 + 8 Cooling only</p>																							
Maximum allowable length	Actual pipe length [Example] unit 8: a+b+c+d+e+s≤150 m Equivalent pipe length between outdoor and indoor units ≤175 m (Assume equivalent pipe length of refnet joint to be 0.5 m and of the refnet header to be 1.0 m, that of BSVQ100 and BSVQ160 to be 4 m and that of BSVQ250 to be 6 m (for calculation purposes)). Total extension length Total piping length from outdoor unit* to all indoor units ≤300 m	[Example] unit 6: a+b+1 ≤150 m, unit 8: a+m+n+p≤150 m	[Example] unit 8: a+o≤150 m																								
Allowable height	Between outdoor branch and outdoor unit (Only for REYQ18 or more) Piping length from outdoor branch to outdoor unit ≤10 m. Approximately length: max. 13 m Between outdoor and indoor units Difference in height between outdoor and indoor units (H1)≤50 m (≤40 m if outdoor unit is located in a lower position). Between indoor and indoor units Difference in height between adjacent indoor units (H2)≤15 m Between outdoor and outdoor units Difference in height between outdoor unit (main) and outdoor unit (sub) (H3)≤5 m	Difference in height between outdoor and indoor units (H1)≤50 m (≤40 m if outdoor unit is located in a lower position). Difference in height between adjacent indoor units (H2)≤15 m Difference in height between outdoor unit (main) and outdoor unit (sub) (H3)≤5 m	<p>r≤10 m (Approximately length: max. 13 m) s≤10 m (Approximately length: max. 13 m) t≤10 m (Approximately length: max. 13 m)</p>																								
Allowable length after the branch	Pipe length from first refrigerant branch kit (either refnet joint or refnet header) to indoor unit ≤40 m [Example] unit 8: b+c+d+e+s≤40 m	[Example] unit 6: b+1≤40 m, unit 8: m+n+p≤40 m	[Example] unit 8: o≤40 m																								
Refrigerant branch kit selection Refrigerant branch kits can only be used with R-410A.	How to select the refnet joint * When using refnet joints at the first branch counted from the outdoor unit side. Choose from the following table in accordance with the capacity of the outdoor unit. <table border="1" style="width: 100%; border-collapse: collapse;"> <thead> <tr> <th style="background-color: #f2f2f2;">Outdoor unit capacity type</th> <th style="background-color: #f2f2f2;">Refrigerant branch kit name</th> </tr> </thead> <tbody> <tr> <td>REYQ8+10</td> <td>KHRQ23M29T</td> </tr> <tr> <td>REYQ12~22</td> <td>KHRQ23M64T</td> </tr> <tr> <td>REYQ24~48</td> <td>KHRQ23M75T</td> </tr> </tbody> </table> * For refnet joints other than the first branch, select the proper branch kit model based on the total capacity index.	Outdoor unit capacity type	Refrigerant branch kit name	REYQ8+10	KHRQ23M29T	REYQ12~22	KHRQ23M64T	REYQ24~48	KHRQ23M75T	How to select the refnet header * Choose from the following table in accordance with the total capacity of all the indoor units connected below the refnet header. * Note: 250 type cannot be connected below the refnet header.	<table border="1" style="width: 100%; border-collapse: collapse;"> <thead> <tr> <th style="background-color: #f2f2f2;">Indoor capacity type</th> <th style="background-color: #f2f2f2;">In case of 3 pipes</th> <th style="background-color: #f2f2f2;">Refrigerant branch kit name</th> <th style="background-color: #f2f2f2;">In case of 2 pipes</th> </tr> </thead> <tbody> <tr> <td><200</td> <td>KHRQ23M29T</td> <td>KHRQ22M29H</td> <td>KHRQ22M29H</td> </tr> <tr> <td>200≤x<290</td> <td>KHRQ23M64T</td> <td>KHRQ22M64H</td> <td>KHRQ22M64H</td> </tr> <tr> <td>290≤x<640</td> <td>KHRQ23M75T</td> <td>KHRQ22M75H</td> <td>—</td> </tr> </tbody> </table>	Indoor capacity type	In case of 3 pipes	Refrigerant branch kit name	In case of 2 pipes	<200	KHRQ23M29T	KHRQ22M29H	KHRQ22M29H	200≤x<290	KHRQ23M64T	KHRQ22M64H	KHRQ22M64H	290≤x<640	KHRQ23M75T	KHRQ22M75H	—
Outdoor unit capacity type	Refrigerant branch kit name																										
REYQ8+10	KHRQ23M29T																										
REYQ12~22	KHRQ23M64T																										
REYQ24~48	KHRQ23M75T																										
Indoor capacity type	In case of 3 pipes	Refrigerant branch kit name	In case of 2 pipes																								
<200	KHRQ23M29T	KHRQ22M29H	KHRQ22M29H																								
200≤x<290	KHRQ23M64T	KHRQ22M64H	KHRQ22M64H																								
290≤x<640	KHRQ23M75T	KHRQ22M75H	—																								
Example of downstream indoor units	[Example] in case of refnet joint B; indoor units 5+6+7+8 [Example] in case of refnet joint C; indoor units 5+6+7+8	[Example] in case of refnet joint B; indoor units 7+8, in case of refnet header; indoor units 1+2+3+4+5+6+7+8 [Example] in case of refnet joint C; indoor units 7+8, in case of refnet header; indoor units 1+2+3+4+5+6+7+8	[Example] in case of refnet joint B; indoor units 7+8, in case of refnet header; indoor units 1+2+3+4+5+6+7+8 [Example] in case of refnet joint C; indoor units 7+8, in case of refnet header; indoor units 1+2+3+4+5+6+7+8																								

Pipe size selection
For an outdoor unit multi installation (REYQ18~48), make the settings in accordance with the following figure.

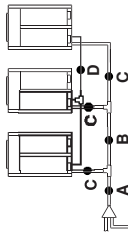

A. Piping between outdoor unit and refrigerant branch kit
• Match to the size of the connection piping on the outdoor unit.

Outdoor unit connection piping size

Outdoor unit capacity type	Piping size (outer diameter)		Gas pipe Discharge	
	Liquid pipe	Suction	Suction	Discharge
REYQ8	Ø9.5	Ø19.1	Ø19.1	Ø15.9
REYQ10	Ø9.5	Ø22.2	Ø19.1	Ø19.1
REYQ12	Ø12.7	Ø28.6	Ø22.2	Ø22.2
REYQ14+16	Ø15.9	Ø34.9	Ø28.6	Ø28.6
REYQ20+22	Ø19.1	Ø41.3	Ø34.9	Ø34.9
REYQ26~34	Ø19.1	Ø41.3	Ø34.9	Ø34.9
REYQ36	Ø19.1	Ø41.3	Ø34.9	Ø34.9
REYQ38~48	Ø19.1	Ø41.3	Ø34.9	Ø34.9

Pipe size when overall equivalent pipe length is 90 m or more

• When overall equivalent pipe length is 90 m or more, the size of the main liquid pipe (outdoor unit branch sections) must be increased. (Only main liquid pipe)

Main liquid pipe size

Outdoor capacity type	Piping size (outer diameter) Normal size	Size up
REYQ8~10	Ø9.5	Ø12.7
REYQ12~16	Ø12.7	Ø15.9
REYQ18~24	Ø15.9	Ø19.1
REYQ26~48	Ø19.1	Ø22.2

How to calculate the additional refrigerant to be charged
Additional refrigerant to be charged R (kg)
R should be rounded off in units of 0.1 kg

NOTE

If a negative result is gotten for R from the formula at right, no refrigerant needs to be added nor removed.

B. Piping between outdoor branches

• Choose from the following table in accordance with the total capacity of all the outdoor units connected above this.

Outdoor capacity index	Piping size (outer diameter)		Gas pipe Discharge	
	Liquid pipe	Suction	Suction	Discharge
REYQ18	Ø15.9	Ø28.6	Ø22.2	Ø22.2
REYQ20+22	Ø15.9	Ø34.9	Ø28.6	Ø28.6
REYQ24	Ø19.1	Ø41.3	Ø34.9	Ø34.9
REYQ26	Ø19.1	Ø41.3	Ø34.9	Ø34.9

Between two immediately adjacent refrigerant branch kits and BS unit

• Choose from the following table in accordance with the total capacity of all the indoor units connected below this.
• Do not let the connection piping exceed the refrigerant piping size chosen by general system model name.

Indoor capacity index	Piping size (outer diameter)		Gas pipe Discharge	
	Liquid pipe	Suction	Suction	Discharge
<62.5 ^(*)	Ø6.4	Ø12.7	Ø9.5	Ø9.5
62.5x<200	Ø9.5	Ø15.9	Ø12.7	Ø12.7
200x<290	Ø12.7	Ø22.2	Ø19.1	Ø19.1
290x<420	Ø15.9	Ø28.6	Ø28.6	Ø28.6
420x<640	Ø19.1	Ø34.9	Ø34.9	Ø34.9
640x<920	Ø19.1	Ø41.3	Ø41.3	Ø41.3
≥920	Ø19.1	Ø41.3	Ø41.3	Ø41.3

(*) The BS unit (BSVQ100MV1) port and connection pipe are different sizes. Use the reducing joints included with the BS unit.

• When two pipes are connected between two adjacent refrigerant branch kits, select the proper gas pipe size based on data mentioned under "suction gas pipe" column in the table above.

C. Piping between outdoor branch and outdoor unit

• Choose from the following table in accordance with the total capacity of all the outdoor units connected above this.

Outdoor unit capacity type	Piping size (outer diameter)		Gas pipe Discharge	
	Liquid pipe	Suction	Suction	Discharge
REYQ8	Ø9.5	Ø19.1	Ø19.1	Ø15.9
REYQ10	Ø9.5	Ø22.2	Ø19.1	Ø19.1
REYQ12	Ø12.7	Ø28.6	Ø22.2	Ø22.2
REYQ14+16	Ø15.9	Ø34.9	Ø28.6	Ø28.6

D. Oil-equalizing line (Only for REYQ18 or greater)

Piping size

Between BS unit (refrigerant branch kit) and indoor unit

• Pipe size for direct connection to indoor unit must be the same as the connection size of indoor unit.

Indoor capacity Index	Piping size (outer diameter)	
	Gas pipe	Liquid pipe
20, 25, 32, 40, 50 ^(*)	Ø12.7	Ø6.4
63, 80, 100, 125	Ø15.9	Ø6.4
200	Ø19.1	Ø9.5
250	Ø22.2	Ø9.5

(*) The BS unit (BSVQ100MV1) port and connection pipe are different sizes. Use the reducing joints included with the BS unit.

$$R = \left(\left(\text{Total length (m) of liquid piping size at } \varnothing 22.2 \right) \times 0.35 + \left(\text{Total length (m) of liquid piping size at } \varnothing 19.1 \right) \times 0.25 + \left(\text{Total length (m) of liquid piping size at } \varnothing 15.9 \right) \times 0.17 + \left(\text{Total length (m) of liquid piping size at } \varnothing 12.7 \right) \times 0.11 \right) \times 1.15 - \left(\text{Total length (m) of liquid piping size at } \varnothing 6.4 \right) \times 0.022$$

NOTE

If a negative result is gotten for R from the formula at right, no refrigerant needs to be added nor removed.

Example for refrigerant branch using refnet joint and refnet header for REYQ34

If the outdoor unit is REYQ34 and the piping lengths are as below

a: Ø19.1x30 m	d: Ø9.5x10 m	g: Ø6.4x10 m	j: Ø6.4x10 m
b: Ø15.9x10 m	e: Ø9.5x10 m	h: Ø6.4x20 m	k: Ø6.4x9 m
c: Ø9.5x10 m	f: Ø9.5x10 m	i: Ø12.7x10 m	

$$R = [30 \times 0.25 + 10 \times 0.17 + 10 \times 0.11 + 40 \times 0.054 + 49 \times 0.022] \times 1.15 - 6 = 9.569 \Rightarrow R = 9.6 \text{ kg}$$

Model	Amount of refrigerant
REYQ8~16	0 kg
REYQ18~32	3 kg
REYQ34~48	6 kg

6.4. Leak test and vacuum drying

The units were checked for leaks by the manufacturer.

See [figure 12](#) and refer to "6.6. Additional refrigerant charge" on [page 10](#) for nomenclature of the parts in [figure 12](#).

- Confirm that the suction, discharge and liquid line stop valves (and oil-equalizing stop valve in case of a 18~48 type unit as well) are firmly closed before pressure test or vacuuming.
- Make sure that valves A + B + C are completely open.

Air tight test and vacuum drying

- **Air tight test:** Make sure to use nitrogen gas. (For the service port location, refer to the "Caution" label attached on the front panel of the outdoor unit.)

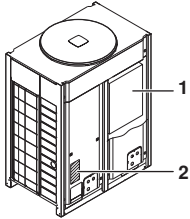

- 1 Electric box lid
- 2 Caution label location

Pressurize the liquid, suction gas and discharge gas pipes (and oil-equalizing pipe in case of REYQ18~48 type) to 3.8 MPa (38 bar) (do not pressurize more than 3.8 MPa (38 bar)). If the pressure does not drop within 24 hours, the system passes the test. If the pressure drops, check where the nitrogen leaks from.

- **Vacuum drying:** Use a vacuum pump which can evacuate to -100.7 kPa (5 Torr, -755 mm Hg)

1. Evacuate the system from the liquid, suction gas and discharge gas pipes (and oil-equalizing pipe in case of REYQ18~48 type) by using a vacuum pump for more than 2 hours and bring the system to -100.7 kPa. After keeping the system under that condition for more than 1 hour, check if the vacuum gauge rises or not. If it rises, the system may either contain moisture inside or have leaks.
2. Following should be executed if there is a possibility of moisture remaining inside the pipe (if piping work is carried out during the raining season or over a long period of time, rainwater may enter the pipe during work).

After evacuating the system for 2 hours, pressurize the system to 0.05 MPa (vacuum break) with nitrogen gas and evacuate the system again using the vacuum pump for 1 hour to -100.7 kPa (vacuum drying). If the system cannot be evacuated to -100.7 kPa within 2 hours, repeat the operation of vacuum break and vacuum drying.

Then, after leaving the system in vacuum for 1 hour, confirm that the vacuum gauge does not rise.

NOTE  Make sure to perform airtightness test and vacuum drying using the service ports of the stop valve shown in the table below.

REYQ8~16	Liquid line stop valve Discharge gas line stop valve Suction gas line stop valve
REYQ18~48	Liquid line stop valve Discharge gas line stop valve Suction gas line stop valve Oil-equalizing line stop valve

Stop valve operation procedure

Introduction

Confirm the sizes of the stop valves connected to the system referring to the table below.

	REYQ8	REYQ10	REYQ12	REYQ14	REYQ16
Liquid line stop valve	Ø9.5		Ø12.7		
Suction gas line stop valve	Ø22.2 ^(*)		Ø25.4 ^(†)		
Discharge gas line stop valve	Ø19.1 ^(‡)		Ø19.1 ^(**)		

- (*) The model REYQ8 supports on-site piping of Ø19.1 by the accessory pipes.
- (†) The model REYQ16 supports on-site piping of Ø28.6 by the accessory pipes.
- (‡) The model REYQ8 supports on-site piping of Ø15.9 by the accessory pipes.
- (**) The model REYQ14+16 supports on-site piping of Ø22.2 by the accessory pipes.

Opening stop valve

1. Remove the cap and turn the valve counterclockwise with the hexagon wrench.
2. Turn it until the shaft stops.
Do not apply excessive force to the stop valve. Doing so may break the valve body, as the valve is not a backseat type. Always use the special tool.
3. Make sure to tighten the cap securely.

Closing stop valve

1. Remove the cap and turn the valve clockwise with the hexagon wrench.
2. Securely tighten the valve until the shaft contacts the main body seal.
3. Make sure to tighten the cap securely.
For the tightening torque, refer to the table below.

Tightening torque N·m (Turn clockwise to close)					
stop valve size	Cap			Service port	Suction line piping attached to unit (1)
	Shaft (valve body)	Hexagonal wrench	Flare nut		
Ø6.4	5.4~6.6	Hexagonal wrench 4 mm	13.5~16.5	11.5~13.9	14~17
Ø9.5			18~22		33~39
Ø12.7	8.1~9.9	Hexagonal wrench 6 mm	23~27		50~60
Ø19.1	13.5~16.5	Hexagonal wrench 10 mm	36~44	97~119	—
Ø22.2	27~33	Hexagonal wrench 10 mm	36~44	—	
Ø25.4				22~28	

(See [figure 11](#))

- 1 Service port
- 2 Cap
- 3 Hexagon hole
- 4 Shaft
- 5 Seal

CAUTION

- Always use a charge hose for service port connection.
- After tightening the cap, check that no refrigerant leaks are present.

FLARE SHAPE and FLARENUT TIGHTENING TORQUE

Precautions when connecting pipes

- See the following table for flare part machining dimensions.
- When connecting the flare nuts, apply refrigerant oil to the inside and outside of the flares and turn them three or four times at first. (Use ether or ester oil).

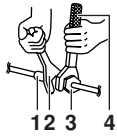

- Piping union
- Spanner
- Flare nut
- Torque wrench

- When loosening a flare nut, always use two wrenches in combination. When connecting the piping, always use a spanner and torque wrench in combination to tighten the flare nut.
- See the following table for tightening torque. (Applying too much torque may cause the flares to crack.)
- After all the piping has been connected, use nitrogen to perform a gas leak check.

Pipe size	Tightening Torque (N·m)	A (mm)	Flare shape
Ø9.5	32.7~39.9	12.8~13.2	
Ø12.7	49.5~60.3	16.2~16.6	
Ø15.9	61.8~75.4	19.3~19.7	

NOTE



You must use a torque wrench but if you are obliged to install the unit without a torque wrench, you may follow the installation method mentioned below.

After the work is finished, make sure to check that there is no gas leak.

When you keep on tightening the flare nut with a spanner, there is a point where the tightening torque suddenly increases. From that position, further tighten the flare nut within the angle shown below:

Pipe size	Further tightening angle	Recommended arm length of tool
Ø9.5 (3/8")	60~90°	±200 mm
Ø12.7 (1/2")	30~60°	±250 mm
Ø15.9 (5/8")	30~60°	±300 mm

6.5. Pipe insulation

After finishing the leak test and vacuum drying, the piping must be insulated. Take into account the following points:

- Make sure to insulate the connection piping and refrigerant branch kits entirely.
- Be sure to insulate liquid, suction gas, and discharge gas piping (for all units) and oil equalizing pipe (only for REYQ18~48).
- Use heat resistant polyethylene foam which can withstand a temperature of 70°C for liquid side piping and polyethylene foam which can withstand a temperature of 120°C for gas side piping.
- If you think the temperature and the relative humidity around the cooling pipes might exceed 30°C and RH 80%, reinforce the insulation of the cooling pipes (at least 20 mm thick). Condensation might be formed on the surface of the insulation.

- If there is a possibility that condensation on the stop valve might drip down into the indoor unit through gaps in the insulation and piping because the outdoor unit is located higher than the indoor unit this must be prevented by sealing up the connections. See figure 13.

- One outdoor unit installed
 - When multiple outdoor units installed
- Liquid line stop valve
 - Suction gas line stop valve
 - Discharge gas line stop valve
 - Indoor to outdoor interconnecting piping
 - Sealing up treatment
 - Heat insulator
 - Oil-equalizing line stop valve
 - Oil-equalizing line



Be sure to insulate local pipes, as touching them can cause burns.

6.6. Additional refrigerant charge



Refrigerant cannot be charged until field wiring has been completed.

Refrigerant may only be charged after performing the leak test and the vacuum drying (see above).

When charging a system, care shall be taken that its maximum permissible charge is never exceeded, in view of the danger of liquid hammer.

Charging with an unsuitable substance may cause explosions and accidents, so always ensure that the appropriate refrigerant (R-410A) is charged.

Refrigerant containers shall be opened slowly.

Always use protective gloves and protect your eyes when charging refrigerant.

See figure 12.

- Pressure reducing valve
- Nitrogen
- Tank
- Siphon system
- Measuring instrument
- Vacuum pump
- Valve A
- Valve B
- Suction gas line stop valve
- Liquid line stop valve
- Discharge gas line stop valve
- stop valve service port
- Charge hose
- Indoor unit
- BS unit
- Oil-equalizing line stop valve
- Valve C
- Outdoor unit
- Dotted lines represent onsite piping
- To indoor unit

To avoid compressor breakdown. Do not charge the refrigerant more than the specified amount.

- This outdoor unit is factory charged with refrigerant and depending on pipe sizes and pipe lengths some systems require additional charging of refrigerant. (Refer to "How to calculate the additional refrigerant to be charged" on page 8).
- Make sure to use installation tools you exclusively use on R-410A installations to withstand the pressure and to prevent foreign materials from mixing into the system.
- Charge the refrigerant to the liquid pipe in its liquid state. Since R-410A is a mixed refrigerant, its composition changes if charged in a state of gas and normal system operation would no longer be assured.
- Before filling, check whether the tank has a siphon attached or not.

How to fill a tank with a siphon attached

Fill with the tank upright.
There is a siphon tube inside, so there is no need to turn the tank upside-down.



Other ways of filling the tank

Fill with the tank upside-down.



- Determine the weight of refrigerant to be charged additionally referring to the item "Additional refrigerant charge" in "How to calculate the additional refrigerant to be charged" on page 8 and fill in the amount in the "Additional refrigerant charge label" attached to the unit.

Charging while the outdoor unit is at a standstill

- After the vacuum drying is finished, charge the additional refrigerant in its liquid state through the liquid stop valve service port taking into account following instructions:
 - Check that gas and liquid stop valves are closed.
 - Stop the compressor and charge the specified weight of refrigerant.



If the total refrigerant cannot be charged while the outdoor unit is at a standstill, it is possible to charge the refrigerant by operating the outdoor unit using the refrigerant charge function (refer to "Setting mode 2" on page 17).

Charging while the outdoor unit is operating

- 1 Completely open the suction and discharge gas line stop valves. In case of a 18~48 type unit, completely open the oil pressure equalizer stop valves as well. Valve A + B (+ C in case of a 18~48 type unit) must be left fully closed. Make sure the liquid line stop valve is totally shut. If it is open, the refrigerant cannot be charged. Charge the additional refrigerant in its liquid state through the service port of the liquid line stop valve.
- 2 While the unit is at a standstill and under setting mode 2 (refer to 8.2. Checks before initial start-up, "Setting the mode" on page 17), set the required function A (additional refrigerant charging operation) to ON (ON). Then operation starts. The blinking H2P led indicates test operation and the remote controller indicates TEST (test operation) and  (external control).
- 3 When the specified amount of refrigerant is charged, push the BS3 RETURN button. Then operation stops.
 - The operation automatically stops within 30 minutes.
 - If the refrigerant charge cannot be finished within 30 minutes, repeat step 2.
 - If the operation stops immediately after restart, there is a possibility that the system is overcharged. The refrigerant cannot be charged more than this amount.

- 4 After the refrigerant charge hose is removed, make sure to fully open the liquid stop valve. Otherwise the piping may burst due to blocked liquid.
- 5 After the refrigerant is charged, turn on the power for the indoor units and for the outdoor unit.

7. FIELD WIRING



All field wiring and components must be installed by a licensed electrician and must comply with relevant local and national regulations.

The field wiring must be carried out in accordance with the wiring diagrams and the instructions given below.

Be sure to use a dedicated power circuit. Never use a power supply shared by another appliance.

This product's reversed phase protection detector only works when the product started up.

The reversed phase protection detector is designed to stop the product in the event of an abnormalities when the product is started up.

Replace two of the three phases (L1, L2, and L3) during reverse-phase protection circuit operation.

Reversed phase detection is not performed while the product is operating.





If there exists the possibility of reversed phase after an momentary black out and the power goes on and off while the product is operating, attach a reversed phase protection circuit locally. Running the product in reversed phase can break the compressor and other parts.

7.1. Internal wiring - Parts table

Refer to the wiring diagram sticker on the unit. The abbreviations used are listed below:

A1P-A7P	Printed circuit board
BS1-5	Push button switch (mode, set, return, wiring check, reset)
C1-4	Capacitor
DS1	Dip switch
E1HC~3HC	Crankcase heater
F1U	Fuse (250 V, 5 A, B)(A4P)
F1U,2U	Fuse (250 V, 10 A, B)(A1P)
F5U	Field fuse
H1P-8P	Light emitting diode (service monitor - orange)
HAP	Pilot lamp (service monitor - green)
K1M~3M	Compressor contactor (M1C~M3C)
K1R-15R	Magnetic relay
L1R	Reactor
M1C,2C,3C	Motor (compressor)
M1F	Motor (fan)
PS	Switching power supply
Q1RP	Reverse phase detector
R1	Resistor (current limiting)
R3-4	Resistor
R10-R133	Resistor (current sensor)
R1T	Thermistor (fin) (A2P)
R1T	Thermistor (air) (A1P)
R2T	Thermistor (suction)
R31T~33T	Thermistor (discharge)

R4T.....	Thermistor (coil-deicer)
R5T.....	Thermistor (coil-outlet)
R6T.....	Thermistor (liquid-pipe receiver)
R7T.....	Thermistor (oil)
R81T-82T.....	Thermistor (coil gas)
S1NPH.....	Pressure sensor (high)
S1NPL.....	Pressure sensor (low)
S1PH,3PH.....	Pressure switch (high)
T1A.....	Current sensor (A5P,A6P)
T1R.....	Transformer
V1CP.....	Safety devices input
V1R.....	Power module (A2P,A3P)
X1M.....	Terminal strip (Power supply)
X1M.....	Terminal strip (control)(A1P)
Y1E,2E,3E.....	Expansion valve (electronic type)
Y1S.....	Solenoid valve (hotgas bypass)
Y2S.....	Solenoid valve (out-multi)
Y3S.....	Solenoid valve (receiver gas intake)
Y4S.....	Solenoid valve (receiver gas purge)
Y5S.....	Solenoid valve (gas purge)
Y6S.....	Solenoid valve (liquid pipe)
Y7S.....	Solenoid valve (gas pipe)
Y8S.....	Solenoid valve (4 way valve main)
Y9S.....	Solenoid valve (4 way valve sub)
Z1C-7C.....	Noise filter (ferrite core)
Z1F.....	Noise filter (with surge absorber)

	Field wiring
L1,L2,L3.....	Live
N.....	Neutral
	Connector
	Wire clamp
	Protective earth (screw)
BLK.....	Black
BLU.....	Blue
BRN.....	Brown
GRY.....	Gray
ORG.....	Orange
PNK.....	Pink
RED.....	Red
WHT.....	White
YLW.....	Yellow

- NOTE**
- Use copper conductors only.
 - When using the adaptor for sequential start, refer to "7.4. Examples" on page 13.
 - For connection wiring to outdoor-outdoor transmission F1-F2, outdoor-indoor transmission F1-F2, outdoor-multi transmission Q1-Q2, refer to "7.4. Examples" on page 13.
 - For connection wiring to the central remote controller, refer to the installation manual of the central remote controller.
 - Use insulated wire for the power cord.

7.2. Power circuit and cable requirements

A power circuit (see table below) must be provided for connection of the unit. This circuit must be protected with the required safety devices, i.e. a main switch, a slow blow fuse on each phase and an earth leak detector.

Model	Phase and frequency	Voltage	Recommended fuses	Transmission line section
REYQ8	3N~50 Hz	400 V	32 A	0.75~1.25 mm ²
REYQ10	3N~50 Hz	400 V	32 A	0.75~1.25 mm ²
REYQ12	3N~50 Hz	400 V	32 A	0.75~1.25 mm ²
REYQ14	3N~50 Hz	400 V	50 A	0.75~1.25 mm ²
REYQ16	3N~50 Hz	400 V	50 A	0.75~1.25 mm ²
REYQ18	3N~50 Hz	400 V	63 A	0.75~1.25 mm ²
REYQ20	3N~50 Hz	400 V	63 A	0.75~1.25 mm ²
REYQ22	3N~50 Hz	400 V	63 A	0.75~1.25 mm ²
REYQ24	3N~50 Hz	400 V	80 A	0.75~1.25 mm ²
REYQ26	3N~50 Hz	400 V	80 A	0.75~1.25 mm ²
REYQ28	3N~50 Hz	400 V	80 A	0.75~1.25 mm ²
REYQ30	3N~50 Hz	400 V	100 A	0.75~1.25 mm ²
REYQ32	3N~50 Hz	400 V	100 A	0.75~1.25 mm ²
REYQ34	3N~50 Hz	400 V	100 A	0.75~1.25 mm ²
REYQ36	3N~50 Hz	400 V	100 A	0.75~1.25 mm ²
REYQ38	3N~50 Hz	400 V	100 A	0.75~1.25 mm ²
REYQ40	3N~50 Hz	400 V	125 A	0.75~1.25 mm ²
REYQ42	3N~50 Hz	400 V	125 A	0.75~1.25 mm ²
REYQ44	3N~50 Hz	400 V	125 A	0.75~1.25 mm ²
REYQ46	3N~50 Hz	400 V	125 A	0.75~1.25 mm ²
REYQ48	3N~50 Hz	400 V	125 A	0.75~1.25 mm ²

When using residual current operated circuit breakers, be sure to use a high-speed type 300 mA rated residual operating current.

Be sure to install a main switch for the complete system.

- NOTE**
- Select the power supply cable in accordance with relevant local and national regulations.
 - Wire size must comply with the applicable local and national code.
 - Specifications for local wiring power cord and branch wiring are in compliance with IEC60245.
 - WIRE TYPE H05VV(*)
*Only in protected pipes (use H07RN-F when protected pipes are not used).

7.3. General

- Up to 3 units can be connected by crossover power source wiring between outdoor units. However, units of smaller capacity must be connected downstream. For details, refer to the equipment design data and technical data.
- When connecting several units in VRV+ combination, the power supply of each outdoor unit can also be connected separately. Refer to the field wiring on the engineering data book for further details.
- Make sure to connect the power source wire to the power source terminal block and to clamp it as shown in figure 14, chapter "Field line connection".
- As this unit is equipped with an inverter, installing a phase advancing capacitor not only will deteriorate power factor improvement effect, but also may cause capacitor abnormal heating accident due to high-frequency waves. Therefore, never install a phase advancing capacitor.
- Keep power imbalance within 2% of the supply rating.
 - Large imbalance will shorten the life of the smoothing capacitor.
 - As a protective measure, the product will stop operating and an error indication will be made, when power imbalance exceeds 4% of the supply rating.
- Follow the "electrical wiring diagram" when carrying out any electrical wiring.

- Only proceed with wiring work after blocking off all power.
- Always ground wires. (In accordance with national regulations of the pertinent country.)
- Do not connect the ground wire to gas pipes, sewage pipes, lightning rods, or telephone ground wires.
 - Combustion gas pipes: can explode or catch fire if there is a gas leak.
 - Sewage pipes: no grounding effect is possible if hard plastic piping is used.
 - Telephone ground wires and lightning rods: dangerous when struck by lightning due to abnormal rise in electrical potential in the grounding.
- This unit uses an inverter, and therefore generates noise, which will have to be reduced to avoid interfering with other devices. The outer casing of the product may take on an electrical charge due to leaked electrical current, which will have to be discharged with the grounding.
- Be sure to install an earth leak detector. (One that can handle higher harmonics.)
(This unit uses an inverter, which means that an earth leak detector capable of handling high harmonics needs to be used in order to prevent malfunctioning of the earth leak detector itself.)
- Earth leak detector which are especially for protecting ground-faults should be used in conjunction with main switch or fuse for use with wiring.
- This unit has a negative phase protection circuit. (If it operates, only operate the unit after correcting the wiring.)

7.4. Examples

System example (See figure 18)

1	Field power supply
2	Main switch
3	Earth leak detector
4	Fuse
5	Cool/heat selector
6	Remote controller
7	Outdoor unit
8	BS unit
9	Indoor unit
—	Power supply wiring (sheathed cable)
—	Transmission wiring (sheathed cable)



Field line connection

L1, L2, L3, N-phase of the power cord should be clamped to the plastic bracket using field supplied clamp material.

The green and yellow striped wrapped wires should be used for grounding. (See figure 14)

- 1 Power supply (400 V, Three-phase)
- 2 Fuse
- 3 Grounding wire
- 4 Earth leak detector
- 5 Attach insulation sleeves
- 6 Power supply terminal block
- 7 Ground wire
- 8 Clamp the ground wires along with the power wires using field supplied clamps.
- 9 Clamp each power wire separately to the plastic bracket using field supplied clamps.
- 10 When wiring, do not allow the ground wires to contact the compressor lead wires. If the wires contact each other, adverse effects may occur to other units.
- 11 When connecting two wires to one terminal, ensure that the crimp-style terminals face with each other back to back. Moreover, make sure that the wire of the smaller gauge is located above.
- 12 Crimp-style terminal
- 13 Wire gauge: Small
- 14 Wire gauge: Large
- 15 Plastic bracket

(See figure 20)

- 1 Electric wiring
- 2 Wiring between units
- 3 Clamp to the electric box with field supplied clamps.
- 4 When routing out the power/ground wires from the right side:
- 5  When routing the remote control cord and inter-unit wiring, secure clearance of 50 mm or more from the power wiring. Ensure that the power wiring does not contact any heated sections ().
- 6 Clamp to the back of the column support with field supplied clamps.
- 7 When routing out the inter-unit wirings from the opening for piping:
- 8 When routing out the power/ground wires from the front:
- 9 When routing out the ground wires from the left side:
- 10 Grounding wire
- 11 When wiring, pay attention not to detach the acoustic insulators from the compressor.
- 12 Power supply
- 13 Fuse
- 14 Earth leakage breaker
- 15 Ground wire
- 16 Unit A
- 17 Unit B
- 18 Unit C



Precautions when laying power wiring

Use round pressure terminals for connections to the power terminal block.

When none are available, follow the instructions below.

- Do not connect wiring of different thicknesses to the power terminal block. (Slack in the power wiring may cause abnormal heat.)
- When connecting wiring which is the same thickness, do as shown in the figure below.

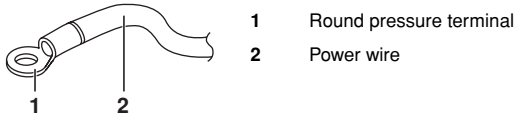

- For wiring, use the designated power wire and connect firmly, then secure to prevent outside pressure being exerted on the terminal board.
- Use an appropriate screwdriver for tightening the terminal screws. A screwdriver with a small head will strip the head and make proper tightening impossible.
- Over-tightening the terminal screws may break them.
- See the table below for tightening torque for the terminal screws.

Tightening torque (N·m)	
M8 (Power terminal block)	5.5~7.3
M8 (Ground)	
M3 (Inter-unit wiring terminal block)	0.8~0.97

Precautions when connecting the ground

When pulling the ground wire out, wire it so that it comes through the cut out section of the cup washer. (An improper ground connection may prevent a good ground from being achieved.)

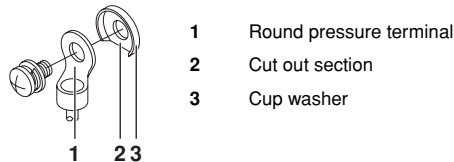

Field line connection: transmission wiring and cool/heat selection

In case of REYQ8~16 (See figure 19)

- Outdoor unit
- Outdoor unit PC board (A1P)
- BS unit A
- BS unit B
- Last BS unit
- Indoor unit
- Remote controller
- Cool-only unit
- Use the conductor of sheathed wire (2 wire) (no polarity)

In case of REYQ18~48 (See figure 10)

- Unit A (Base unit)
- Unit B
- Unit C
- To multi unit
- To indoor unit
- To outdoor unit

Fixing field line connection (See figure 17)

- Fix to the indicated plastic brackets using field supplied clamping material.
- Wiring between the units (Outdoor - outdoor)
- Wiring between the units (Indoor - outdoor)
- Wiring for multi connection (only for REYQ18~48)
- Plastic bracket



- Be sure to follow the limits below. If the unit-to-unit cables are beyond these limits, it may result in malfunction of transmission.
Maximum wiring length: 1000 m
Total wiring length: 2000 m
Maximum No. of branches: 16
 - Maximum number of outdoor units connectable: 10.
 - Up to 16 branches are possible for unit-to-unit cabling. No branching is allowed after branching. (See figure 8)
- Branch
 - Subbranching
- Never connect the power supply to unit-to-unit cabling terminal block. Otherwise the entire system may break down.

Sequential start

Make the outdoor unit cable connections shown below.

The outdoor unit PC board (A1P) is factory set at "Sequential start available".



For low-noise operation, it is necessary to get the optional 'External control adaptor for outdoor unit' (DTA104A61/62).

For details, see the installation manual attached to the adaptor.

Picking power line and transmission line

- Be sure to let the power line and the transmission line pass through a conduit hole.
 - Pick the power line from the upper hole on the left side plate, from the front position of the main unit (through the conduit hole of the wiring mounting plate) or from a knock out hole to be made in the unit's bottom plate. (See figure 16)
- A** Electric wiring diagram. Printed on the back of the electric box lid.
- 1 Cut off the shaded zones before use.
 - 2 Through cover
 - 3 Power wiring between outdoor units
(When the wiring is routed out through the lateral panel.)
 - 4 Set apart
 - 5 Transmission wire
 - 6 Knockout hole
 - 7 Power wiring between outdoor units (when wiring is routed through the front panel)

Precautions when knocking out knock holes

- To punch a knock hole, hit on it with a hammer.
- After knocking out the holes, we recommend you paint the edges and areas around the edges using the repair paint to prevent rusting.
- When passing electrical wiring through the knock holes, remove any burrs from the knock holes and wrap the wiring with protective tape to prevent damage.

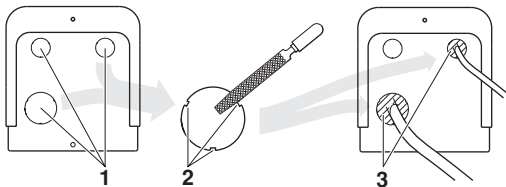

- 1 Knockout hole
- 2 Burr
- 3 If there are any possibilities that small animals enter the system through the knock holes, plug the holes with packing materials (to be prepared on-site).



- Use a power wire pipe for the power wiring.
- Outside the unit, make sure the low voltage electric wiring (i.e. for the remote control, between units, etc.) and the high voltage electric wiring do not pass near each other, keeping them at least 50 mm apart. Proximity may cause electrical interference, malfunctions, and breakage.
- Be sure to connect the power wiring to the power wiring terminal block and secure it as described under "Field line connection" on page 13.
- Inter-unit wiring should be secured as described in "Field line connection" in chapter "7.4. Examples" on page 13.
 - Secure the wiring with the accessory clamps so that it does not touch the piping.
 - Make sure the wiring and the electric box lid do not stick up above the structure, and close the cover firmly.

Never connect 400 V to the terminal block of the interconnecting wiring. Doing so will break the entire system.

- The wiring from the indoor units must be connected to the F1/F2 (In-Out) terminals on the PC board in the outdoor unit.
 - After installing the interconnecting wires inside the unit, wrap them along with the on-site refrigerant pipes using finishing tape, as shown in figure 9.
- 1 Liquid pipe
 - 2 Suction gas pipe
 - 3 Discharge gas pipe
 - 4 Interconnecting wiring
 - 5 Insulator
 - 6 Finishing tape

For the above wiring, always use vinyl cords with 0.75 to 1.25 mm² sheath or cables (2 core wires).

In case of REYQ18~48

- The interconnecting wiring between the outdoor units in the same pipe line must be connected to the Q1/Q2 (Out Multi) terminals. Connecting the wires to the F1/F2 (Out-Out) terminals results in system malfunction.
- The wiring for the other lines must be connected to the F1/F2 (Out-Out) terminals of the P-board in the outdoor unit to which the interconnecting wiring for the indoor units is connected.
- The base unit is the outdoor unit to which the interconnecting wiring for the indoor units is connected.
- The interconnecting wiring between the outdoor units must be ≤30 m.
See the paragraph "Fixing field line connection" on page 14.



- Be sure to keep the power line and transmission line apart from each other.
- Be careful about polarity of the transmission line.
- Make sure that the transmission line is clamped as shown in the figure in "Field line connection" in chapter "7.4. Examples" on page 13.
- Check that wiring lines do not make contact with refrigerant piping.
- Firmly close the lid and arrange the electrical wires so as to prevent the lid or other parts from coming loose.
- When you do not use a wire conduit, be sure to protect the wires with vinyl tubes etc, to prevent the edge of the knock-out hole from cutting the wires.

8. BEFORE OPERATION

8.1. Service precautions



WARNING: ELECTRIC SHOCK



Caution when performing service to inverter equipment

- Do not touch live parts for 10 minutes after the power supply is turned off because of high voltage risk.
- Additionally, measure the points as shown in the figure with a tester and confirm that the voltage of the capacitor in the main circuit is not higher than 50 V DC.

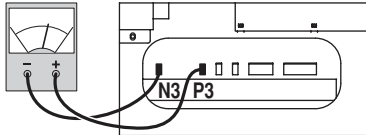

Then pull out the connector (N3, P3). Make sure you do not touch live parts.

- After the service is finished, re-connect the connector (N3, P3). Otherwise malfunction may occur.

Caution when obtaining access to terminals

- Before obtaining access to terminals in the switch box, all supply circuits must be disconnected.
- Be careful when removing the cover. Touching live parts may cause electric shock.
- After servicing is finished, re-attach the cover. Otherwise malfunction may occur due to intrusion of water or other foreign materials.

NOTE

Be safe!



In order to protect the PCB, touch the switch box casing with your hand so as to eliminate static electricity from your body before performing service.

8.2. Checks before initial start-up



- Make sure that the circuit breaker on the power supply panel of the installation is switched off.
- Attach the power wire securely.
- Introducing power with a missing N-phase or with a mistaken N-phase will break the equipment.

After the installation, check the following before switching on the circuit breaker:

- 1 The position of the switches that require an initial setting
Make sure that switches are set according to your application needs before turning the power supply on.
- 2 Power supply wiring and transmission wiring
Use a designated power supply and transmission wiring and make sure that it has been carried out according to the instructions described in this manual, according to the wiring diagrams and according to local and national regulations.
- 3 Pipe sizes and pipe insulation
Make sure that correct pipe sizes are installed and that the insulation work is properly executed.
- 4 Additional refrigerant charge
The amount of refrigerant to be added to the unit should be written on the included "Added Refrigerant" plate and attached to the rear side of the front cover.

- 5 Insulation test of the main power circuit

Using a megatester for 500 V, check that the insulation resistance of 2 MΩ or more is attained by applying a voltage of 500 V DC between power terminals and earth. Never use the megatester for the transmission wiring.

- 6 Installation date

Be sure to keep record of the installation date on the sticker on the rear of the upper front panel according to EN60335-2-40.

8.3. Field setting

If required, carry out field settings according to the following instructions. Refer to the service manual for more details.

Opening the switch box and handling the switches

When carrying out field settings, remove the switch box cover (1). Operate the switches with an insulated stick (such as a ball-point pen) to avoid touching live parts.



Do not forget to re-attach the switch box cover (1) when you are done.

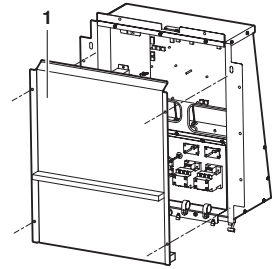

Location of the dip switches, leds and buttons

- 1 Led H1~7P
- 2 Push button switches BS1~BS5
- 3 Dip switch 1 (DS1: 1~4)
- 4 Dip switch 2 (DS2: 1~4)
- 5 Dip switch 3 (DS3: 1~2)

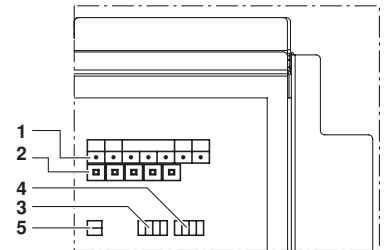

Led state

Throughout the manual the state of the leds is indicated as follows:

- OFF
- ON
- ⦿ blinking

Setting the dip switches (only in case of a heat pump unit)

What to set with dip switch DS1	
1	COOL/HEAT selector (refer to "Field line connection: transmission wiring and cool/heat selection" on page 14) (OFF = not installed = factory setting)
2~4	NOT USED DO NOT CHANGE THE FACTORY SETTING.
What to set with dip switch DS2	
1~4	NOT USED DO NOT CHANGE THE FACTORY SETTING.
What to set with dip switch DS3	
1+2	NOT USED DO NOT CHANGE THE FACTORY SETTING.

Setting the push button switch (BS1~5)

Function of the push button switch which is located on the outdoor unit PCB (A1P):

MODE	TEST: ●	C/H SELECT			L.N.O.P	DEMAND
	HWL: ○	IND	MASTER	SLAVE		
● H1P	● H2P	○ H3P	● H4P	● H5P	● H6P	● H7P



- BS1 MODE** For changing the set mode
- BS2 SET** For field setting
- BS3 RETURN** For field setting
- BS4 TEST** For test operation
- BS5 RESET** For resetting the address when the wiring is changed or when an additional indoor unit is installed

The figure shows state of the led indications when the unit is shipped from the factory.

Setting the mode

The set mode can be changed with the **BS1 MODE** button according to the following procedure:

- **For setting mode 1:** Press the **BS1 MODE** button once, the H1P led is off ●.
- **For setting mode 2:** Press the **BS1 MODE** button for 5 seconds, the H1P led is on ○.

If the H1P led is blinking ● and the **BS1 MODE** button is pushed once, the setting mode will change to setting mode 1.

NOTE If you get confused in the middle of the setting process, push the **BS1 MODE** button. Then it returns to setting mode 1 (H1P led is off).

Setting mode 1 (not in case of cooling only unit)

The H1P led is off (COOL/HEAT selection setting).

Setting procedure

- 1 Push the **BS2 SET** button and adjust the led indication to either one of the possible settings as shown below in the field marked :

- 1 In case of COOL/HEAT setting by each individual outdoor unit circuit.
- 2 In case of COOL/HEAT setting by the master unit when outdoor units are connected in multiple system-combination (*).
- 3 In case of COOL/HEAT setting by the slave unit when outdoor units are connected in multiple system-combination (*).

	H1P	H2P	H3P	H4P	H5P	H6P	H7P
1	●	●	○	●	●	●	●
2	●	●	●	○	●	●	●
3	●	●	●	●	○	●	●

(*) It is necessary to use the optional external control adapter for outdoor unit (DTA104A61/62). See the instruction delivered with the adapter.

- 2 Push the **BS3 RETURN** button and the setting is defined.

Setting mode 2

The H1P led is on.

Setting procedure

- 1 Push the **BS2 SET** button according to the required function (A~G). The led indication that matches the required function is shown below in the field marked :

Possible functions

- A additional refrigerant charging operation.
- B refrigerant recovery operation/vacuuuming operation.
- C setting of high static pressure.
- D automatic low noise operation setting at nighttime.
- E low noise operation level setting (L.N.O.P) via the external control adapter.
- F power consumption limitation setting (DEMAND) via the external control adapter.
- G enabling function of the low noise operation level setting (L.N.O.P) and/or power consumption limitation setting (DEMAND) via the external control adapter (DTA104A61/62).

	H1P	H2P	H3P	H4P	H5P	H6P	H7P
A	○	●	○	●	○	●	●
B	○	●	○	●	○	●	○
C	○	●	○	●	●	○	●
D	○	●	○	○	○	○	●
E	○	●	○	○	●	●	○
F	○	●	○	○	○	○	●
G	○	●	●	○	○	●	●

- 2 When the **BS3 RETURN** button is pushed, the current setting is defined.
 - 3 Push the **BS2 SET** button according to the required setting possibility as shown below in the field marked .
- 3.1 Possible settings for function A, B, C and G are ON (ON) or OFF (OFF).

	H1P	H2P	H3P	H4P	H5P	H6P	H7P
ON	○	●	●	●	●	○	●
OFF(*)	○	●	●	●	●	●	○

(*) This setting = factory setting

- 3.2 Possible settings for function D

The noise of level 3 < level 2 < level 1 (▲ 1).

	H1P	H2P	H3P	H4P	H5P	H6P	H7P
OFF(*)	○	●	●	●	●	●	●
▲ 1	○	●	●	●	●	●	○
▲ 2	○	●	●	●	●	○	○
▲ 3	○	●	●	●	●	○	○

(*) This setting = factory setting

- 3.3 Possible settings for function E and F

For function E (L.N.O.P) only: the noise of level 3 < level 2 < level 1 (▲ 1).

For function F (DEMAND) only: the power consumption of level 3 < level 2 < level 1 (▲ 1).

	H1P	H2P	H3P	H4P	H5P	H6P	H7P
▲ 1	○	●	●	●	○	○	○
▲ 2(*)	○	●	●	●	○	○	○
▲ 3	○	●	●	●	○	○	○

(*) This setting = factory setting

- 4 Push the **BS3 RETURN** button and the setting is defined.
- 5 When the **BS3 RETURN** button is pushed again, the operation starts according to the setting.

Refer to the service manual for more details and for other settings.

The following items can be confirmed by setting mode 1 (H1P led is off)

Check the led indication in the field marked .

- 1 Indication of the present operation state
 - ● normal
 - ○ abnormal
 - ● under preparation or under test operation

H1P	H2P	H3P	H4P	H5P	H6P	H7P
●	●	○	●	●	●	●

- 2 Indication of COOL/HEAT selection setting
 - 1 When set to COOL/HEAT change-over by each individual outdoor unit circuit (= factory setting).
 - 2 Indication on master unit when COOL/HEAT change-over is carried out by outdoor system connected in multiple system-combination.
 - 3 Indication on slave unit when COOL/HEAT change-over is carried out by outdoor system connected in multiple system-combination.

	H1P	H2P	H3P	H4P	H5P	H6P	H7P
1 ^(*)	●	●	○	●	●	●	●
2	●	●	●	○	●	●	●
3	●	●	●	●	○	●	●

(*) This setting = factory setting.

- 3 Indication of low noise operation state L.N.O.P
 - ● standard operation (= factory setting)
 - ○ L.N.O.P operation

H1P	H2P	H3P	H4P	H5P	H6P	H7P
●	●	○	●	●	●	●

- 4 Indication of power consumption limitation setting DEMAND
 - ● standard operation (= factory setting)
 - ○ DEMAND operation

H1P	H2P	H3P	H4P	H5P	H6P	H7P
●	●	○	●	●	●	●

8.4. Test operation

NOTE



- In case of 18~48 type: check the setting and the indication results. Refer to chapter "Caution for 18~48 type units" on page 19.
- After turning on the power supply, the unit cannot be started until the H2P initialisation led goes off (maximum 12 minutes).

- Check the stop valves
 - In case of 5~16 type: Make sure to open the suction and discharge gas line stop valves and the liquid line stop valve.
 - In case of 18~48 type: Make sure to open the oil pressure equalizing stop valves as well.
- After installation, perform the test operation. Unless the test operation is performed, the error code "U3" is shown on the remote controller and the unit cannot be operated.

Performing the test operation

- 1 To protect the compressor, make sure to turn on the power supply 6 hours before starting operation.
- 2 Set to setting mode 1 (H1P led is off) (refer to "Setting mode 1" on page 17).
- 3 Press the **BS4 TEST** button for 5 seconds (or longer when the unit is at a standstill). The test operation starts when the H2P led blinks and the remote controller indicates **TEST** (test operation) and (external control).

It may take 10 minutes to bring the state of refrigerant uniform before the compressor starts, but that is not a malfunction.

The test operation is automatically carried out in cooling mode during 15~30 minutes.

Depending on the situation, the refrigerant running sound or the sound of a magnetic solenoid valve may rise during this operation.

The following items are automatically checked:

- Check for miswiring
- Check if stop valves are open
- Check of refrigerant charge
- Automatic judgement of piping length

NOTE



When you want to terminate the test operation, press the **BS3 RETURN** button. The unit will keep running for 30 seconds and then stops. During test operation it is impossible to stop the unit with the remote controller.

- 4 After the test operation (maximum 30 minutes), the unit automatically stops. Check the operation results by the outdoor unit led indication.

	H1P	H2P	H3P	H4P	H5P	H6P	H7P
normal	●	●	○	●	●	●	●
abnormal	●	○	○	●	●	●	●



- Indoor units cannot be checked individually. After the test operation is finished, check the indoor units individually via the remote controller.
- The led indication changes during this operation, but that is not abnormal.
- Please attach the front plate of the outdoor unit in order to prevent incorrect judgement during operation.

- 5 Measure to be taken when operation finishes abnormally
 1. Confirm the error code on the remote controller.
 2. Correct what is abnormal.
(See the installation manual and operation manual or contact your dealer.)
 3. After the error is corrected, press the **BS3 RETURN** button and reset the error code.
 4. Start the unit again to confirm that the problem is properly solved.

Remote controller displays an error:

Installation error	Malfunction code	Remedial action
The stop valve of an outdoor unit is left closed.	E3 E4 F3 UF	Check referring to the table in "Additional refrigerant charge" on page 10.
The phases of the power to the outdoor units are reversed.	U1	Exchange two of the three phases (L1, L2, L3) to make a positive phase connection.
No power is supplied to an outdoor or indoor unit (including phase interruption).	U1 U4	Check if the power wiring for the outdoor units are connected correctly. (If the power wire is not connected to L2 phase, no malfunction display will appear and the compressor will not work.)
Incorrect interconnections between units	UF	Check if the refrigerant line piping and the unit wiring are consistent with each other.
Refrigerant overcharge	E3 F6 UF	Recalculate the required amount of refrigerant from the piping length and correct the refrigerant charge level by recovering any excessive refrigerant with a refrigerant recovery machine.
For the REYQ8~16, the wiring is connected to the Q1/Q2 (Out Multi)	U7 UF	Remove the wiring from the Q1/Q2 (Out Multi).
Insufficient refrigerant	E4 F3	Check if the additional refrigerant charge has been finished correctly. Recalculate the required amount of refrigerant from the piping length and add an adequate amount of refrigerant.

6 Caution for 18~48 type units

- Indication of the outdoor unit PCB

	H1P	H2P	H3P	H4P	H5P	H6P	H7P
Master unit	●	●	○	●	●	●	●
Slave unit 1	●	●	●	●	●	●	●
Slave unit 2	●	●	●	●	●	●	●

- The outdoor unit connected to the indoor unit by piping is the master outdoor unit. The other outdoor units (not connected to the indoor unit) are the slave outdoor units.
 - Carry out all the settings of the master unit. Settings on the slave units have no effect.
 - Carry out the leakage and vacuum tests of the oil pressure equalizer and make sure to open the stop valve of the oil equalizer.
 - If the unit is operated with the valve closed, it may not function properly or even damage the equipment.
- 7 If no error code is indicated on the remote controller, it is possible to start operation after 5 minutes.

Temperature adjustment operation confirmation

After the test run is over, operate the unit normally. (Heating is not possible if the outdoor temperature is 24°C or higher.)

- Make sure the indoor and outdoor units are operating normally (If a knocking sound can be heard in the liquid compression of the compressor, stop the unit immediately and then energize the heater for a sufficient length of time before restarting the operation.)
- Run each indoor unit one at a time and make sure the corresponding outdoor unit is also running.
- Check to see if cold (or hot) air is coming out of the indoor unit.
- Press the fan direction and fan strength buttons on the indoor unit to see if they operate properly.



Cautions for normal operation check

- Once stopping, the compressor will not restart in about 5 minutes even if the Run/Stop button of an indoor unit in the same system is pressed.
- When the system operation is stopped by the remote controller, the outdoor units may continue operating for further 5 minutes at maximum.
- If the system has not undergone any check operation by the test operation button since it was first installed, an error code "U3" is displayed. In this case, perform check operation referring to "8.4. Test operation" on page 18.
- After the test run, when handing the unit over to the customer, make sure the electric box lid, the service lid, and the unit casing are all attached.

9. SERVICE MODE OPERATION

Vacuumping method

At the first installation, this vacuuming is not required. It is required only for repair purposes.

- 1 When the unit is at a standstill and under the setting mode 2, set the required function B (refrigerant recovery operation/vacuumping operation) to **ON** (ON).
 - After this is set, do not reset the setting mode 2 until the vacuuming is finished.
 - The H1P led is on and the remote controller indicates **TEST** (test operation) and  (external control) and the operation will be prohibited.
- 2 Evacuate the system with a vacuum pump.
- 3 Press the **BS1 MODE** button and reset the setting mode 2.

Refrigerant recovery operation method

by a refrigerant reclaimer

- 1 When the unit is at a standstill and under the setting mode 2, set the required function B (refrigerant recovery operation/vacuumping operation) to **ON** (ON).
 - The indoor unit and the outdoor unit expansion valves will fully open and some solenoid valves will be turned on.
 - The H1P led is on and the remote controller indicates **TEST** (test operation) and  (external control) and the operation will be prohibited.
- 2 Cut off the power supply to the indoor units and the outdoor unit with the circuit breaker. After the power supply to one side is cut off, cut off the power supply to the other side within 10 minutes. Otherwise, the communication between the indoor and outdoor unit may become abnormal and the expansion valves will be completely closed again.
- 3 Recover the refrigerant by a refrigerant reclaimer. For details, see the operation manual delivered with the refrigerant reclaimer.

10. CAUTION FOR REFRIGERANT LEAKS

(Points to note in connection with refrigerant leaks.)

Introduction

The installer and system specialist shall secure safety against leakage according to local regulations or standards. The following standards may be applicable if local regulations are not available.

The VRV System, like other air conditioning systems, uses R-410A as refrigerant. R-410A itself is an entirely safe non-toxic, non-combustible refrigerant. Nevertheless care must be taken to ensure that air conditioning facilities are installed in a room which is sufficiently large. This assures that the maximum concentration level of refrigerant gas is not exceeded, in the unlikely event of major leak in the system and this in accordance to the local applicable regulations and standards.

Maximum concentration level

The maximum charge of refrigerant and the calculation of the maximum concentration of refrigerant is directly related to the humanly occupied space in to which it could leak.

The unit of measurement of the concentration is kg/m^3 (the weight in kg of the refrigerant gas in 1 m^3 volume of the occupied space).

Compliance to the local applicable regulations and standards for the maximum allowable concentration level is required.

According to the appropriate European Standard, the maximum allowed concentration level of refrigerant to a humanly space for R-410A is limited to 0.44 kg/m^3 .

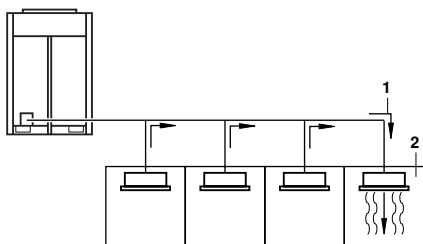

- 1 direction of the refrigerant flow
- 2 room where refrigerant leak has occurred (outflow of all the refrigerant from the system)

Pay special attention to places, such as a basements, etc. where refrigerant can stay, since refrigerant is heavier than air.

Procedure for checking maximum concentration

Check the maximum concentration level in accordance with steps 1 to 4 below and take whatever action is necessary to comply.

- 1 Calculate the amount of refrigerant (kg) charged to each system separately.

$$\begin{array}{l} \text{amount of} \\ \text{refrigerant in a} \\ \text{single unit system} \\ \text{(amount of} \\ \text{refrigerant with} \\ \text{which the system is} \\ \text{charged before} \\ \text{leaving the factory)} \end{array} + \begin{array}{l} \text{additional charging} \\ \text{amount (amount of} \\ \text{refrigerant added} \\ \text{locally in} \\ \text{accordance with the} \\ \text{length or diameter of} \\ \text{the refrigerant} \\ \text{piping)} \end{array} = \begin{array}{l} \text{total amount of} \\ \text{refrigerant (kg) in} \\ \text{the system} \end{array}$$

NOTE



Where a single refrigerant facility is divided into 2 entirely independent refrigerant systems, use the amount of refrigerant with which each separate system is charged.

- 2 Calculate the smallest room volume (m^3)

In a case such as the following, calculate the volume of (A), (B) as a single room or as the smallest room.

- A. Where there are no smaller room divisions

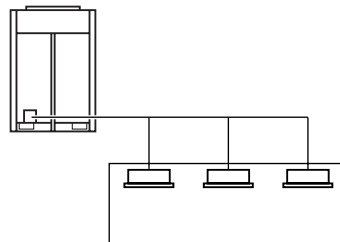

- B. Where there is a room division but there is an opening between the rooms sufficiently large to permit a free flow of air back and forth.

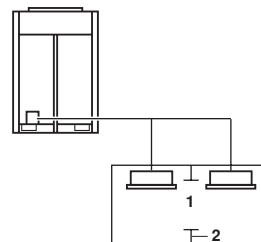

- 1 opening between rooms
- 2 partition

(Where there is an opening without a door or where there are openings above and below the door which are each equivalent in size to 0.15% or more of the floor area.)

- 3 Calculating the refrigerant density using the results of the calculations in steps 1 and 2 above.

$$\frac{\text{total volume of} \\ \text{refrigerant in the} \\ \text{refrigerant system}}{\text{size (m}^3\text{) of smallest} \\ \text{room in which there is} \\ \text{an indoor unit installed}} \leq \text{maximum concentration level (kg/m}^3\text{)}$$

If the result of the above calculation exceeds the maximum concentration level then make similar calculations for the second then third smallest room and so until the result falls short of the maximum concentration.

- 4 Dealing with the situations where the result exceeds the maximum concentration level.

Where the installation of a facility results in a concentration in excess of the maximum concentration level then it will be necessary to revise the system.

Please consult your supplier.

11. DISPOSAL REQUIREMENTS

Dismantling of the unit, treatment of the refrigerant, of oil and of other parts must be done in accordance with relevant local and national legislation.

