

Service Manual

VRV4 heat recovery system



**REMQ5T7Y1B, REYQ8T7Y1B,
REYQ10T7Y1B, REYQ12T7Y1B**



**REYQ14T7Y1B, REYQ16T7Y1B,
REYQ18T7Y1B, REYQ20T7Y1B**

The present publication is drawn up by way of information only and does not constitute an offer binding upon Daikin Europe N.V. Daikin Europe N.V. has compiled the content of this publication to the best of its knowledge. No express or implied warranty is given for the completeness, accuracy, reliability or fitness for particular purpose of its content and the products and services presented therein. Specifications are subject to change without prior notice. Daikin Europe N.V. explicitly rejects any liability for any direct or indirect damage, in the broadest sense, arising from or related to the use and/or interpretation of this publication. All content is copyrighted by Daikin Europe N.V.

Table of contents

Part 1. Introduction	9
1. Version log	9
2. Safety precautions	9
2.1. Meaning of symbols	9
2.2. Warnings	10
2.3. Cautions	11
2.4. Information	12
3. System description	13
3.1. General system layout of a VRV heat recovery system	13
3.2. General built up VRV 4 outdoor heat recovery unit	16
3.3. General built up VRV4 BS unit	18
4. General operation of VRV heat recovery system	20
5. How to use this book	21
5.1. Interactive information flow	21
5.2. Parts of the book	22
5.2.1. The introduction chapter	22
5.2.2. The troubleshooting chapter	22
5.2.3. The repair chapter	22
5.2.4. The maintenance chapter	22
5.2.5. Appendices	22
5.3. Contact information	22
 Part 2. Troubleshooting	 23
1. Error codes	23
1.1. Check for descriptions of malfunctions/retries	23
2. Error code based troubleshooting	25
2.1. "E1" – Outdoor main board (A1P) abnormality	25
2.2. "E3" – High pressure abnormality	25
2.3. "E4" – Abnormal low suction pressure (S1NPL)	26
2.4. "E5" – Compressor motor (M1C, M2C) lock	27
2.5. "E7" – Outdoor unit fan motor (M1F, M2F) lock	27
2.6. "E9" – Outdoor unit expansion valve motor (Y1E~Y6E) detection failure	28
2.7. "F3" – Abnormal discharge pipe temperature (R21T, R22T, R15T) control	28
2.8. "F6" – Refrigerant overcharge	29
2.9. "H9" – Outdoor air thermistor (R1T) abnormality	30
2.10. "J3" – Discharge thermistor (R21T, R22T) or compressor body thermistor (R15T) faulty	30
2.11. "J5" – Suction thermistor or compressor body thermistor (R10T, R12T) faulty	30
2.12. "J6" – Outdoor heat exchanger thermistor (R8T, R9T, R11T) faulty	30
2.13. "J7" – Liquid thermistor faulty (R3T, R7T)	31
2.14. "J8" – Heat exchanger thermistor faulty (R4T, R5T) or receiver bypass thermistor "auto-charge" (R14T) ...	31
2.15. "J9" – Gas thermistor sub-cool or purge faulty (R6T, R13T)	31
2.16. "JA" – High pressure sensor (S1NPH) abnormality	31
2.17. "JC" – Low pressure sensor (S1NPL) abnormality	32
2.18. "LC" – Transmission between main board, auxiliary board and inverter boards	32
2.19. "P1" – Open phase or power supply voltage imbalance	33
2.20. "U1" – Reverse phase or open phase (L3)	33
2.21. "U2" – Power supply inverter circuit abnormality	33
2.22. "U3" – Test run execution failure	34
2.23. "U4" – Communication abnormality between outdoor unit, BS unit and indoor unit	34
2.24. "U7" – Communication abnormality between outdoor units	35

2.25. "U9" – Communication abnormality at other unit in same system	35
2.26. "UA" – Compatibility failure detection	35
2.27. "UF" – Auto address malfunction between outdoor, BS and indoor unit	36
2.28. "UH" – Failure of test run outdoor unit	36
2.29. "P2" – Failure auto-charge function	36
2.30. "PE" – Auto-charge function nearly completed	37
2.31. "P9" – Auto-charge function completed	37
2.32. "E-1" – Refrigerant containment check not possible	37
2.33. "E-2" – Refrigerant containment check indoor air temperature out of range	37
2.34. "E-3" – Refrigerant containment check outdoor air temperature out of range	38
2.35. "E-5" – Refrigerant containment check not possible indoor unit not compatible	38
2.36. "NG" – Refrigerant containment check judges refrigerant leak	38
2.37. "OK" – Refrigerant containment check judges no refrigerant leak	39
3. Subcodes	40
3.1. Error codes related to BS..Q..A	40
3.2. Error codes related to REMQ5T7Y1B, REYQ8~20T7Y1B	40
3.3. Error codes related to FX..Q..M/N/P/A	50
4. Symptom based troubleshooting	52
5. Component checklist	53
5.1. Required tools for component check	53
5.2. Power supply	54
5.3. Thermistors R1T - R15T	56
5.4. Solenoid valves Y11S, Y12S, Y2S and 4-way valves Y3S~Y5S	61
5.5. Motorized expansion valve coil Y1E~Y6E	64
5.6. Fan motor(s) M1F, M2F	67
5.7. Compressor motor M1C, M2C	71
5.8. Inverter boards A3P, A4P, A6P, A7P	75
5.8.1. Inverter board for compressor JT1GCVDKYR (type 1)	75
5.8.2. Inverter board for compressor JT15J-VDKYR (type 2)	79
5.8.3. Inverter board for fan motor	83
5.9. Pressure sensor S1NPH, S1NPL	85
5.10. Pressure switches S1PH, S2PH	89
5.11. Crankcase heater E1HC, E2HC	91

Part 3. Repair 95

1. General Repair procedures	95
1.1. Refrigerant handling procedures	95
1.1.1. Refrigerant Handling	95
1.2. Pipe work procedures	98
1.3. Products	98
1.3.1. Required products when servicing the VRV4 Heat recovery system	98
1.4. Tools	99
1.4.1. Required special tooling when servicing the VRV4 Heat recovery system	99
2. Preliminary actions procedures	100
2.1. Removing bodywork (REMQ5T7Y1B, REYQ8~12T7Y1B)	100
2.1.1. Removing the service plate assembly	100
2.1.2. Removing the upper front plate assembly	101
2.1.3. Removing the front plate assembly	102
2.1.4. Removing the switch box cover	103
2.1.5. Removing the lower front plate assembly	104
2.1.6. Removing the side plate assembly	105
2.1.7. Removing the upper side plate assembly	106
2.1.8. Removing the top plate	107
2.2. Removing bodywork (REYQ14~20T7Y1B)	108
2.2.1. Removing the service plate assembly	108
2.2.2. Removing the upper front plate assembly	109
2.2.3. Removing the front plate assembly	110

2.2.4. Removing the switch box cover	111
2.2.5. Removing the lower front plate assembly	112
2.2.6. Removing the side plate assembly	113
2.2.7. Removing the upper side plate assembly	114
2.2.8. Removing the top plate	115
2.3. Removing bodywork (BS unit)	116
2.3.1. Removing the BS unit cover	116
2.4. Checking the rectifier voltage	117
2.5. Tilting the inverter mounting plate (REYQ14~20T7Y1B)	118
2.6. Removing the inverter mounting plate (REYQ14~20T7Y1B)	120
2.7. Tilting the main and sub board assembly and the power terminal assembly (REMQ5T7Y1B, REYQ8~12T7Y1B)	122
2.8. Unlocking a PCB	123
2.9. Displacing a bracket	124
3. Parts replacement procedures	125
3.1. Replacing a PCB in the switch box	125
3.1.1. Procedure: replacing the A1 PCB (Main)	125
3.1.2. Procedure: replacing the A5P / A8P PCB (Sub)	128
3.1.3. Replacing the noise filter board A2P / A5P (Noise filter)	129
3.1.4. Replacing the compressor inverter board A3P (REMQ5T7Y1B, REYQ8~12T7Y1B)	131
3.1.5. Replacing the compressor inverter board A3P (type 1 (G) compressor) (REYQ14~20T7Y1B)	135
3.1.6. Replacing the compressor inverter board A6P (type 2 (J) compressor) (REYQ14~20T7Y1B)	138
3.1.7. Replacing a fan inverter board A4P (REMQ5T7Y1B, REYQ8~12T7Y1B)	141
3.1.8. Replacing a fan inverter board A4P / A8P (REYQ14~20T7Y1B)	143
3.2. Replacing a thermistor	145
3.3. Replacing a pressure sensor (S1NPH, S1NPL)	147
3.4. Replacing a pressure switch (S1PH, S2PH)	149
3.5. Replacing a 4 way valve coil (Y3S, Y4S, Y5S)	150
3.6. Replacing a solenoid valve coil (Y11S, Y12S)	151
3.7. Replacing a solenoid valve coil (Y2S)	152
3.8. Replacing a 4 way valve (Y3S~Y5S)	153
3.8.1. Replacing 4 way valve Y3S	153
3.8.2. Replacing 4 way valve Y4S	156
3.8.3. Replacing 4 way valve Y5S	158
3.9. Replacing a solenoid valve (Y11S, Y12S, Y2S)	159
3.10. Replacing an expansion valve coil (Y1E, Y3E, Y4E, Y6E)	160
3.11. Replacing an expansion valve coil (Y2E, Y5E)	162
3.12. Replacing an expansion valve	164
3.13. Replacing a fan propeller	167
3.14. Replacing a fan motor	168
3.15. Replacing a compressor	169
3.16. Replacing a crankcase heater E1HC, E2HC	174
3.17. Replacing a reactor (L1R, L2R) (REMQ5T7Y1B, REYQ8~12T7Y1B)	175
3.18. Replacing a reactor (L1R, L2R, L3R) (REYQ14~20T7Y1B)	177
3.19. Replacing the fan assembly	179
3.20. Replacing the heat exchanger	187
3.21. Replacing a control board in the BS unit	194

Part 4. Maintenance	195
1. VRV indoor unit	195
1.2. Maintenance procedures	196
2. HXY080+125A7V1B VRV IV System indoor unit	197
2.2. Maintenance	197
3. REYQ8~20+REMQ5T7Y1B VRV IV system air conditioner	198
3.1. Safety	198
3.2. Maintenance	199
3.2.1. About service mode operation	199
3.3. Maintenance after a long stop period	199
3.4. Maintenance before a long stop period	200
3.5. After sales service and warranty	200
3.5.1. Recommended maintenance and inspection	200
3.5.2. Recommended maintenance and inspection cycles	201
3.5.3. Shortened maintenance and replacement cycles	201
4. FXSQ20~125P7VEB VRV system air conditioners (as reference)	203
4.1. How to clean the air filter	203
4.2. How to clean air outlet and outside panels	204
4.3. Start up after a long stop	205
4.4. What to do when stopping the system for a long period	205
 Part 5. Appendix	 207
1. Field settings	207
1.2. Field settings as per type indoor unit	209
1.3. Field settings full overview	211
2. Wiring diagrams	215
3. Safety device setting value	223
4. Piping diagram	224
5. Piping overview	226

List of figures

Diagnose display and push buttons	24
Required tools for component check	53
rpm counter feedback signal	70
Pressure sensor S1NPL, S1NPH output voltage	88
Required product	98
Required tools	99
Removing the service plate assembly	100
Removing the upper front plate assembly	101
Removing the front plate assembly	102
Removing the switch box cover (REMQ5T7Y1B, REYQ8~12T7Y1B)	103
Removing the lower front plate assembly	104
Removing the side plate assembly	105
Removing the upper side plate assembly	106
Removing the top plate	107
Removing the service plate assembly	108
Removing the upper front plate assembly	109
Removing the front plate assembly	110
Removing the switch box cover	111
Removing the lower front plate assembly	112
Removing the side plate assembly	113
Removing the upper side plate assembly	114
Removing the top plate	115
Removing the BS unit cover	116
Unlocking the inverter mounting plate	118
Tilting the inverter mounting plate	119
Unplugging the A2P / A5P PCB wiring (Noise filter)	120
Unplugging the fan wiring	121
Unlocking and tilting the main and sub board assembly (REMQ5T7Y1B, REYQ8~12T7Y1B)	122
PCB spacer unlatching	123
Displacing a bracket	124
Cable clamp unlatching	125
Replacing the A1P PCB (Main)	126
X40A/X41A wiring A1P PCB (Main)	127
Replacing the A5P / A8P PCB (Sub)	128
Replacing the A2P / A5P PCB (Noise filter)	130
Removing the compressor inverter board A3P - 1	131
Removing the compressor inverter board A3P - 2	132
Removing the compressor inverter board A3P PCB - 3	133
Removing the compressor inverter board A3P PCB - 4	134
Removing the wiring from the A3P PCB (Inv type 1)	136
Removing the A3P PCB (Inv type 1)	137
Removing the wiring from the A6P PCB (Inv type 2)	139
Removing the A6P PCB (Inv type 2)	140
Replacing a fan inverter board (REMQ5T7Y1B, REYQ8~12T7Y1B)	141
Replacing the fan inverter board assembly A4P	142
Replacing the A4P / A8P PCB	144
Replacing a thermistor	146
Removing a pressure sensor (S1NPH, S1NPL) (1)	147
Removing a pressure sensor (S1NPH, S1NPL) (2)	148
Installing a pressure sensor (S1NPH, S1NPL)	149
Removing a 4 way valve (Y3S, Y4S, Y5S) coil	150
Removing a solenoid valve (Y11S, Y12S) coil	151
Removing a solenoid valve (Y2S) coil	152
Removing 4 way valve Y3S	154
Preparing a new 4 way valve Y3S assembly	155
Removing 4 way valve Y4S	156
Preparing a new 4 way valve Y4S assembly	157
Removing 4 way valve Y5S	158
Preparing a new 4 way valve Y5S assembly	159

Removing an expansion valve (Y1E, Y3E, Y4E, Y6E) coil	160
Locking an expansion valve (Y1E, Y3E, Y4E, Y6E) coil	161
Removing an expansion valve (Y2E, Y5E) coil	162
Locking an expansion valve (Y2E, Y5E) coil	163
Removing an expansion valve	165
Installing an expansion valve	166
Removing a fan propeller	167
Removing a fan motor	168
Displacing the insulation	169
Removing the compressor insulation and wiring	170
Removing the compressor wiring	171
Cutting the compressor piping	171
Removing the compressor	172
Installing a new compressor - 1	173
Installing a new compressor - 2	173
Removing a crankcase heater	174
Removing a reactor (L1R, L2R)	175
Removing a reactor (L1R, L2R L3R)	177
Removing the fan assembly (REMQ5TY1B, REYQ8~12T7Y1B) - 1	180
Removing the fan assembly (REMQ5TY1B, REYQ8~12T7Y1B) - 2	181
Removing the fan assembly (REMQ5TY1B, REYQ8~12T7Y1B) - 3	182
Removing the fan assembly (REYQ14~20T7Y1B) - 1	184
Removing the fan assembly (REYQ14~20T7Y1B) - 2	185
Removing the fan assembly (REYQ14~20T7Y1B) - 3	186
Removing the heat exchanger (REMQ5TY1B, REYQ8~12T7Y1B) - 1	188
Removing the heat exchanger (REMQ5TY1B, REYQ8~12T7Y1B) - 2	189
Removing the heat exchanger (REMQ5TY1B, REYQ8~12T7Y1B) - 3	189
Removing the heat exchanger (REMQ5TY1B, REYQ8~12T7Y1B) - 4	190
Removing the heat exchanger (REYQ14~20T7Y1B) - 1	191
Removing the heat exchanger (REYQ14~20T7Y1B) - 2	192
Removing the heat exchanger (REYQ14~20T7Y1B) - 3	193
Removing the heat exchanger (REYQ14~20T7Y1B) - 4	193
Replacement of the BS unit control board	194
Wiring diagram REMQ5T7Y1B-REYQ8T7Y1B	215
Wiring diagram REMQ5T7Y1B-REYQ8T7Y1B (switchbox layout)	216
Wiring diagram REYQ10~12T7Y1B	217
Wiring diagram REYQ10~12T7Y1B (switchbox layout)	218
Wiring diagram REYQ14~16T7Y1B	219
Wiring diagram REYQ14~16T7Y1B (switchbox layout)	220
Wiring diagram REYQ18~20T7Y1B	221
Wiring diagram REYQ18~20T7Y1B (switchbox layout)	222
Piping diagram REMQ5T7Y1B, REYQ8~REYQ12T7Y1B	224
Piping diagram REYQ14~REYQ20T7Y1B	225
Piping overview REMQ5T7Y1B, REYQ8~REYQ12T7Y1B	226
Piping overview REYQ14~REYQ20T7Y1B - part 1	227
Piping overview REYQ14~REYQ20T7Y1B - part 2	228

Part 1. Introduction

1. Version log

Version history.

Version code	Description	Date
Draft 0.1	Preliminary release	18/03/2015
Version 1.0	Document release	19/03/2015

2. Safety precautions

The precautions described in this document cover very important topics, follow them carefully.

All activities described in the service manual must be performed by an authorized person.

If you are not sure how to install, operate or service the unit, contact your dealer.





In accordance with the applicable legislation, it might be necessary to provide a logbook with the product containing at least: information on maintenance, repair work, results of tests, stand-by periods, ...

Also, at least, following information must be provided at an accessible place at the product:

- Instructions for shutting down the system in case of an emergency
- Name and address of fire department, police and hospital
- Name, address and day and night telephone numbers for obtaining service

In Europe, EN378 provides the necessary guidance for this logbook.

2.1. Meaning of symbols

	WARNING Indicates a situation that could result in death or serious injury.
	WARNING: RISK OF ELECTROCUTION Indicates a situation that could result in electrocution.
	WARNING: RISK OF BURNING Indicates a situation that could result in burning because of extreme hot or cold temperatures.
	WARNING: RISK OF EXPLOSION Indicates a situation that could result in explosion.
	WARNING: RISK OF POISONING Indicates a situation that could result in poisoning.

**CAUTION**

Indicates a situation that could result in equipment or property damage.

**INFORMATION**

Indicates useful tips or additional information.

2.2. Warnings

**WARNING**

Improper installation or attachment of equipment or accessories could result in electric shock, short-circuit, leaks, fire or other damage to the equipment. Only use accessories, optional equipment and spare parts made or approved by Daikin.

**WARNING**

Make sure installation, testing and applied materials comply with applicable legislation (on top of the instructions described in the Daikin documentation).

**WARNING**

Make sure the work site environment is clean and safe to work in. Beware of spilled fluids, like water, oil or other substances. Protect bystanders from injury and property from possible damage cause by service works.

**WARNING**

Wear adequate personal protective equipment (protective gloves, safety glasses,...) when installing, maintaining or servicing the system.

**WARNING**

Tear apart and throw away plastic packaging bags so that nobody, especially children, can play with them. Possible risk: suffocation.

**WARNING**

Do NOT touch the air inlet or aluminium fins of the unit.

**WARNING**

- Do NOT place any objects or equipment on top of the unit.
- Do NOT sit, climb or stand on the unit.

**WARNING**

During tests, NEVER pressurize the product with a pressure higher than the maximum allowable pressure (as indicated on the nameplate of the unit).

**WARNING**

- Never mix different refrigerants or allow air to enter the refrigerant system.
- Never charge recovered refrigerant from another unit. Use recovered refrigerant only on the same unit where it was recovered from, or have it recycled at a certified facility.

**WARNING: RISK OF BURNING**

- Do NOT touch the refrigerant piping or internal parts during and immediately after operation. It could be too hot or too cold. Give it time to return to normal temperature. If you must touch it, wear protective gloves.
- Do NOT touch any accidentally leaking refrigerant.

**WARNING**

Always recover the refrigerants. Do NOT release them directly into the environment. Use a vacuum pump to evacuate the installation.

Take sufficient precautions in case of refrigerant leakage. If refrigerant gas leaks, ventilate the area immediately.

Possible risks:

- Excessive refrigerant concentrations in a closed room can lead to oxygen deficiency.
- Toxic gas may be produced if refrigerant gas comes into contact with fire.

Where applicable, pump down the system and close the service valve, before leaving the site if leak was not repaired, to avoid further leaking of the refrigerant.

**WARNING: RISK OF ELECTROCUTION**

- Turn OFF all power supply before removing the switch box cover, connecting electrical wiring or touching electrical parts. Where applicable, stop the equipment's operation first and allow (refrigerant) pressure to equalize, before turning OFF the power. Disconnect the power supply for more than 1 minute, and measure the voltage at the test plug before servicing. The voltage must be less than 10 V DC before you can touch electrical components. For the location of the test plug, refer to "[Checking the rectifier voltage](#)" on page 117.

- Do NOT touch electrical components with wet hands.
- Do NOT leave the unit unattended when the service cover is removed.
- Protect electric components from getting wet while the service cover is opened.

**WARNING**

- Only use copper wires.
- All field wiring must be performed in accordance with the wiring diagram and installation manual supplied with the product.
- If the power cable and lead wires have scratches or deteriorated, be sure to replace them. Damaged cables and wires may cause an electrical shock, excessive heat generation or fire.
- Secure all terminal connections and provide proper routing for cables, both inside and outside the switchbox.
- NEVER squeeze bundled cables and make sure they do not come in contact with the piping and sharp edges.
- Make sure no external pressure is applied to the terminal connections.
- Make sure to check the earth wiring. Do NOT earth the unit to a utility pipe, surge absorber, or telephone earth. Improper earth wiring may cause electrical shock.
- Make sure to use a dedicated power circuit. NEVER use a power supply shared by another appliance.
- Make sure to check the required fuses and/or circuit breakers before starting works.

**WARNING**

- After finishing the electrical work, confirm that each electrical component and terminal inside the electrical components box is connected securely.
- Make sure all covers are closed before starting the unit again.

2.3. Cautions**CAUTION**

Provide adequate measures to prevent that the unit can be used as a shelter by small animals. Small animals that make contact with electrical parts can cause malfunctions, smoke or fire.

2.4. Information



INFORMATION

Make sure refrigerant piping installation complies with applicable legislation. In Europe, EN378 is the applicable standard.



INFORMATION

Make sure the field piping and connections are not subjected to stress.

3. System description

3.1. General system layout of a VRV heat recovery system

The VRV heat recovery system consists of 3 different types of units:

- outdoor unit(s)
- BS unit (Branch Selector unit)
- indoor units.

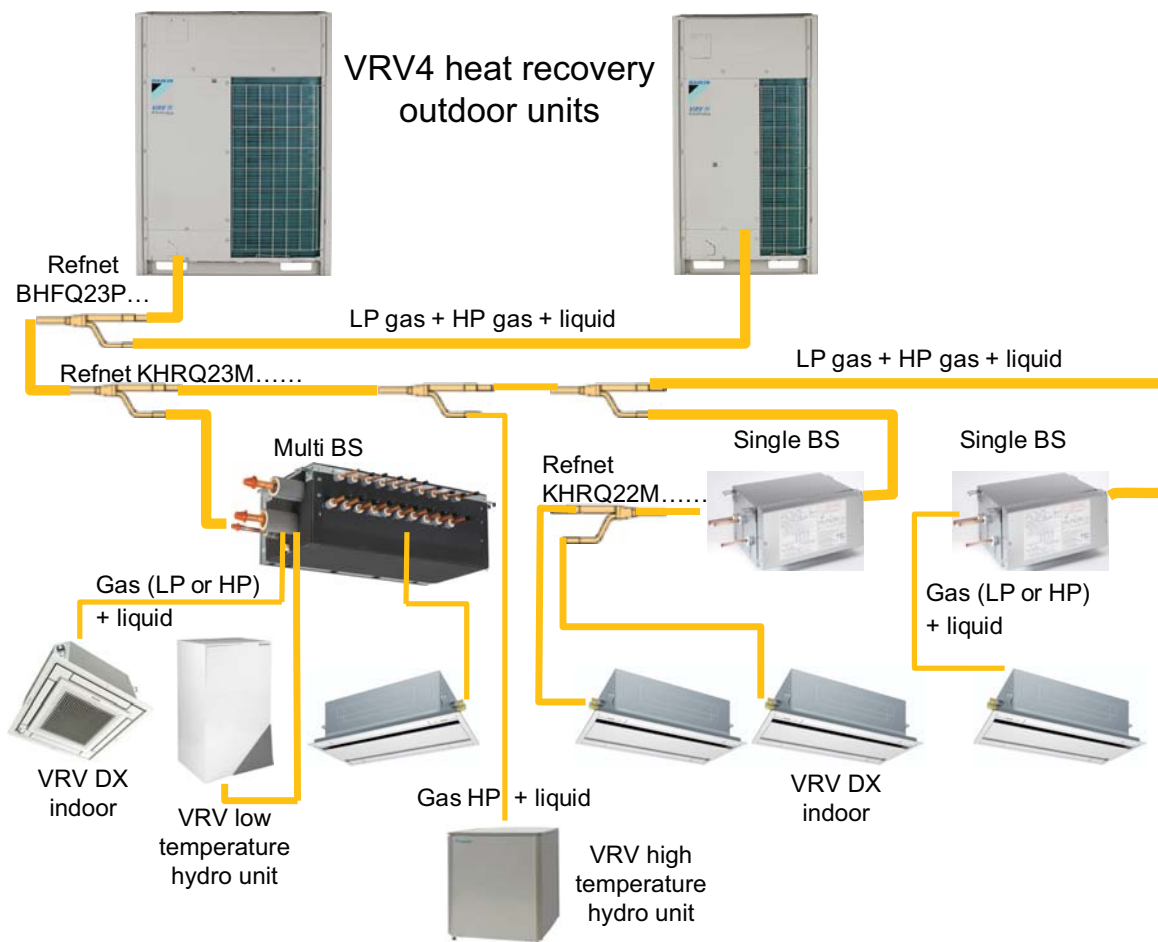

- One to maximum three modules of VRV4 heat recovery outdoor unit can be connected using the optional refnet “BHFQ23P...”.
- Field piping must be thermally insulated copper piping, connected to a combination of “Single circuit BS” unit(s), or/and “Multi circuit BS” unit(s).
- The “Single circuit BS” unit offers 1 change-over circuit. A “Multi circuit BS” unit offers 4, 6, 8, 10, 12 or 16 outlets.
- To split the refrigerant circuit between outdoor unit(s) and the different BS units, Daikin optional accessory refnets (reference “KHRQ23M...”) are used.
- Behind the BS unit, one or more indoor units can be connected. To split the refrigerant circuit to the different indoor units to the same BS unit, Daikin optional accessory refnets (reference “KHRQ22M...”) are used.
- The HT (high temperature) hydrobox is connected without BS unit: only use the HP (high pressure) gas line and the liquid line.

1. Outdoor units exist in different capacities. Two types of casings are used:

- “Medium” casing: REMQ5T7Y1B, REYQ8~12T7Y1B
- “Large” casing: REYQ14~20T7Y1B
- The unit REYQ8~20T7Y1B can be used as “single” unit or combined into a “multi” outdoor combination of maximum three units (refer to databook).
- The unit REMQ5T7Y1B can only be used in multi 2* REMQ5T7Y1B or REMQ5T7Y1B + REYQ8T7Y1B.



“Large” casing



“Medium” casing

2. BS "branch selector" units exists in:

- "Single circuit" BS units: 3 capacities available depending on total capacity indoor units:
 - BS1Q10A: indoor index below 100 (100 not included).
 - BS1Q16A: indoor index from 100 and below 160.
 - BS1Q25A: indoor index from 160 till 250 (250 included).



BS1Q10, 16, 25A

- "Multi circuit" BS units:
 - The maximum number of circuits depend on the model:
 - BS4Q14A: maximum 4 circuits.
 - BS6Q14A: maximum 6 circuits.
 - BS8Q14A: maximum 8 circuits.
 - BS10Q14A: maximum 10 circuits.
 - BS12Q14A: maximum 12 circuits.
 - BS16Q14A: maximum 16 circuits.



BS10Q14A

- Each circuit can have:
 - Maximum five indoor units.
 - Maximum index 140.

3. Indoor units:

- The current available type VRV DX units can be used. Minimum 50% of outdoor index must be connected through BS unit(s).
- The LT (low temperature) hydro unit can be added (BS unit required).
- The HT hydro unit can be added (without BS unit).

3.2. General built up VRV 4 outdoor heat recovery unit

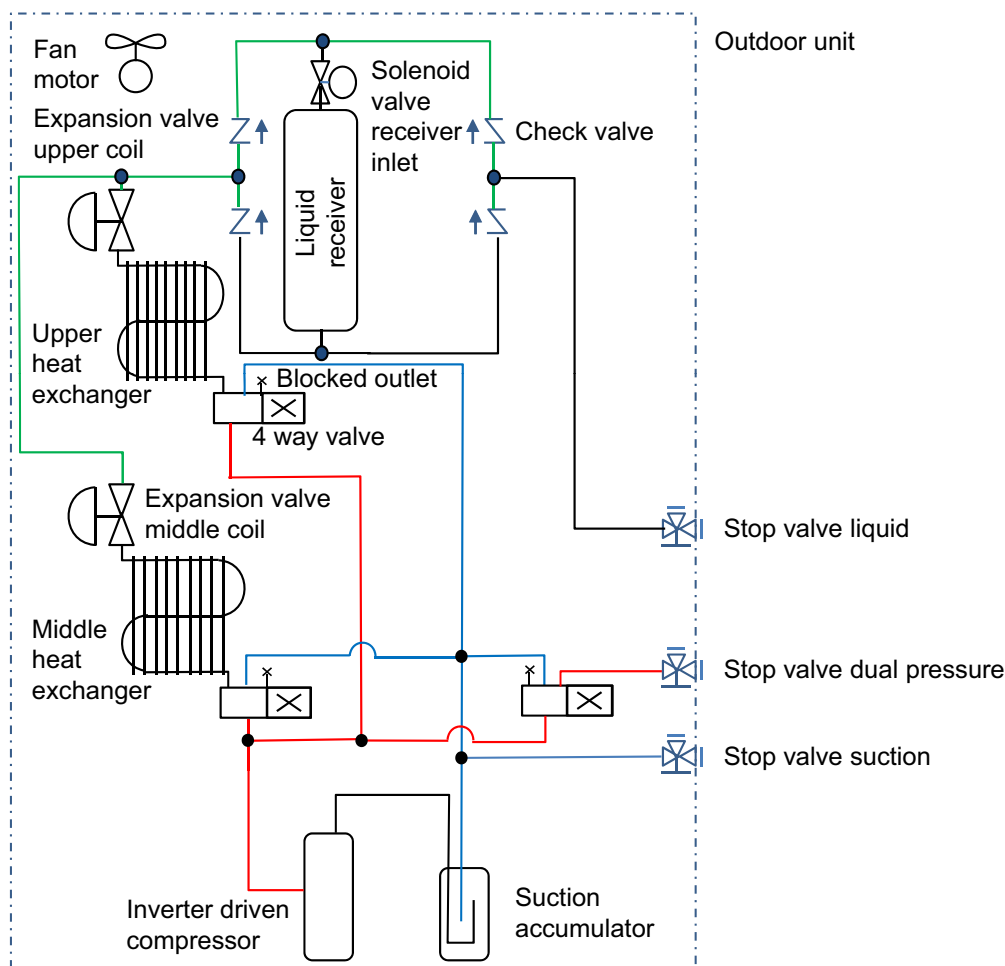

Basic control of the VRV4 heat recovery outdoor unit:

- The rotation speed of the inverter driven compressor, modulated by the inverter, can be varied by 1 rps (= rotation per second). The compressor capacity step is changed in order to reach target compression ratio. The target compression ratio is calculated from deviation between actual and target condensation and evaporation temperature.
- T_c (condensing temperature) is used if any indoor unit operates in heating mode.
- T_e (evaporation temperature) is used if any indoor unit operates in cooling mode.
- Target value is based on initial target value chosen by outdoor unit field settings:
 - [2-8] for T_e ,
 - [2-9] for T_c , and
 - the comfort logic chosen by outdoor field settings [2-81] for T_e , [2-82] for T_c .
- Depending on difference between actual condensation and evaporation temperature to target condensation and evaporation temperature, outdoor control can set the outdoor heat exchangers in following status: both condenser, or upper condenser + lower evaporator, or both evaporator.
- Each heat exchanger has an expansion valve to control the refrigerant flow.

Start-up sequence VRV4 heat recovery outdoor unit

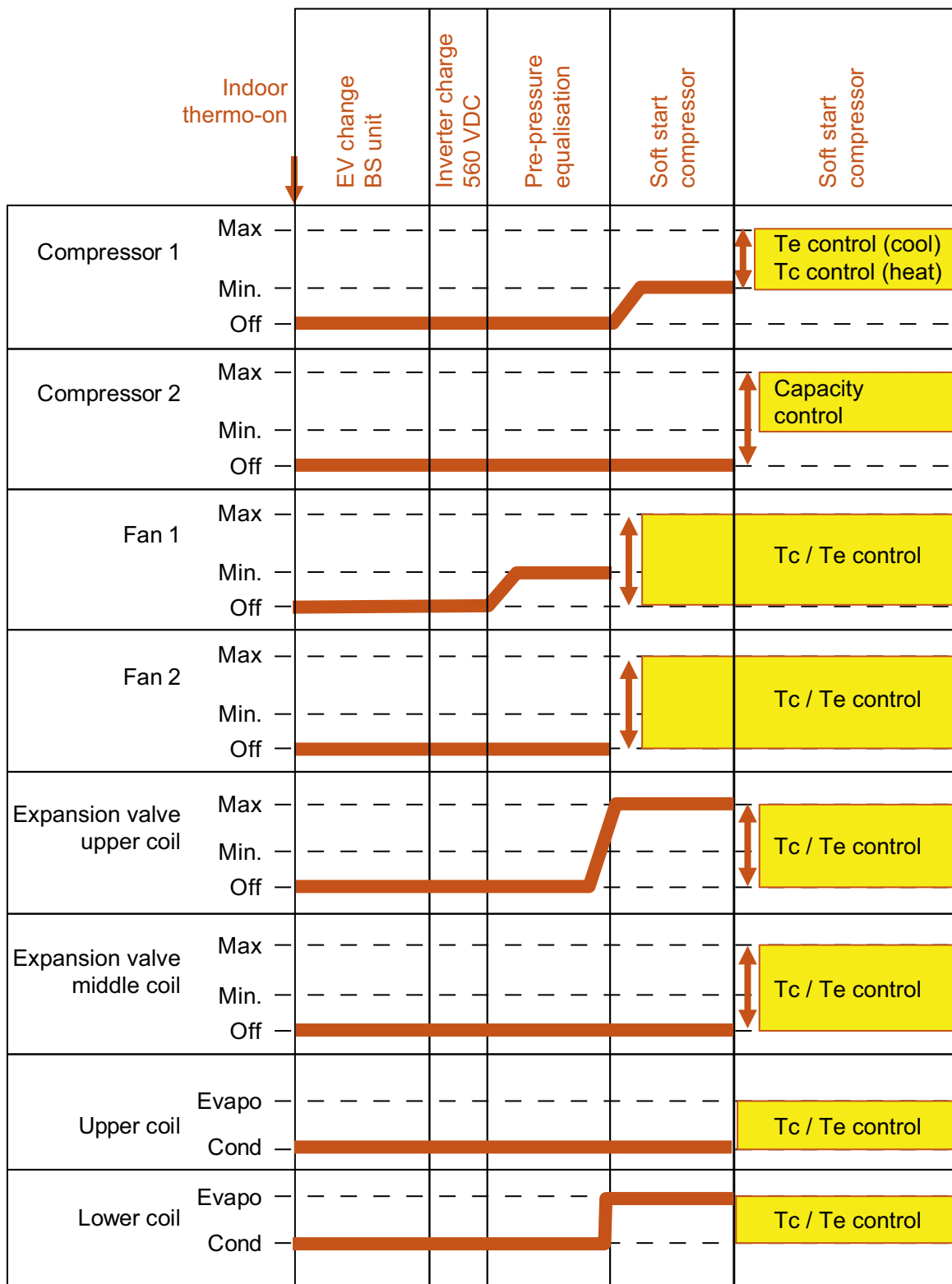

3.3. General built up VRV4 BS unit

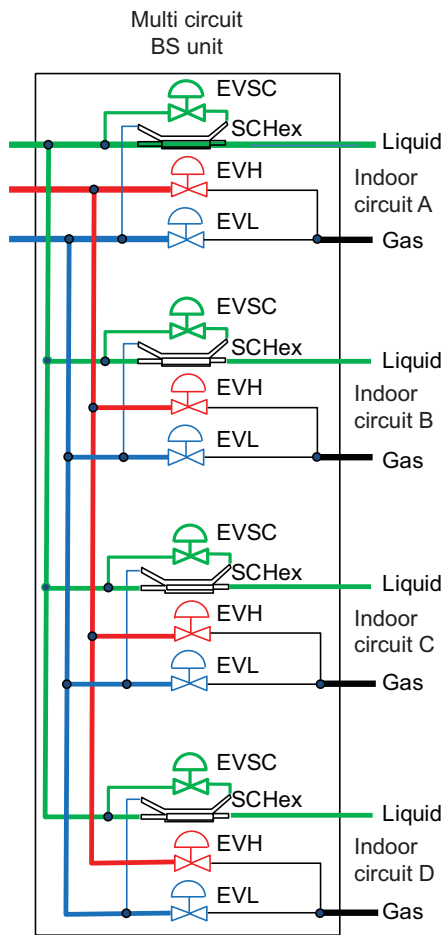
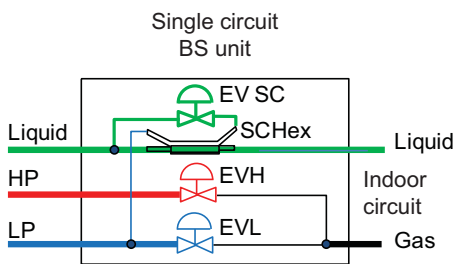

- Each indoor circuit offers the possibility to connect the indoor gas pipe:
 - To the suction side of outdoor unit if indoor unit is set into cooling mode and if the EVL is fully open (after equalization is finished).
 - To the discharge side of outdoor unit if indoor unit is set to heating mode and the EVH is fully open (after equalization is finished).
 - When indoor unit requires to change over between cooling and heating (by automatic change-over, or by changing on indoor remote controller), the pressure will gradually be changed to the required pressure side; to high pressure if heating is required, to low pressure if cooling is required. The change over is set in the outdoor unit field setting [2-71] (default 5 minutes). Sequence of change over shown by graphs on next page.
- The liquid pipe inside the BS unit:
 - Is not shut off.
 - In specific conditions during heat recovery mode (when simultaneous cooling and heating thermostat-on indoor) the internal SCHex (sub-cool heat exchanger) can be used to use limited amount of liquid returning from indoor unit in heating mode, to produce certain degree of (extra) sub-cool before flowing towards the liquid pipe for indoor in cooling thermostat-on. Purpose:
 - To improve cooling capacity.
 - Limit refrigerant noise at indoor unit when expansion valve operating in cooling mode.
 - The opening degree of EVSC (expansion valve sub-cool) is controlled by outdoor unit DSH (discharge superheat) = compressor discharge temperature – Tc.

Change BS unit A-series: cooling => heating

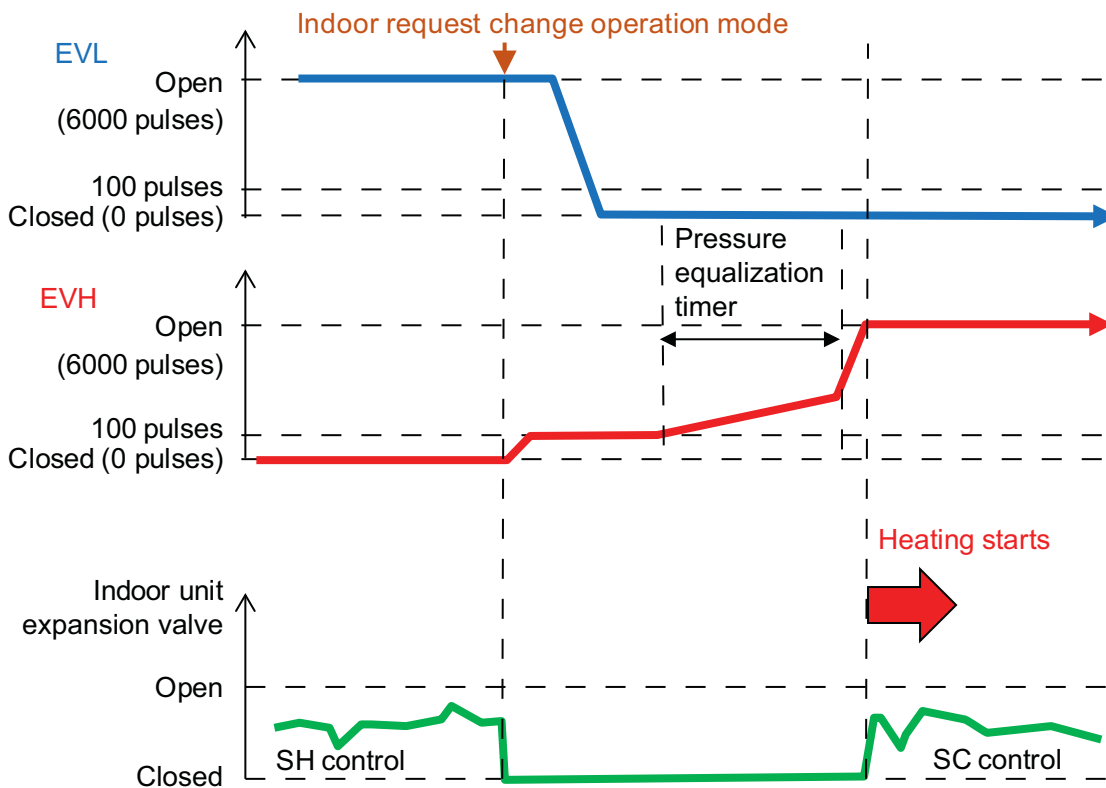

Change BS unit A-series: heating => cooling

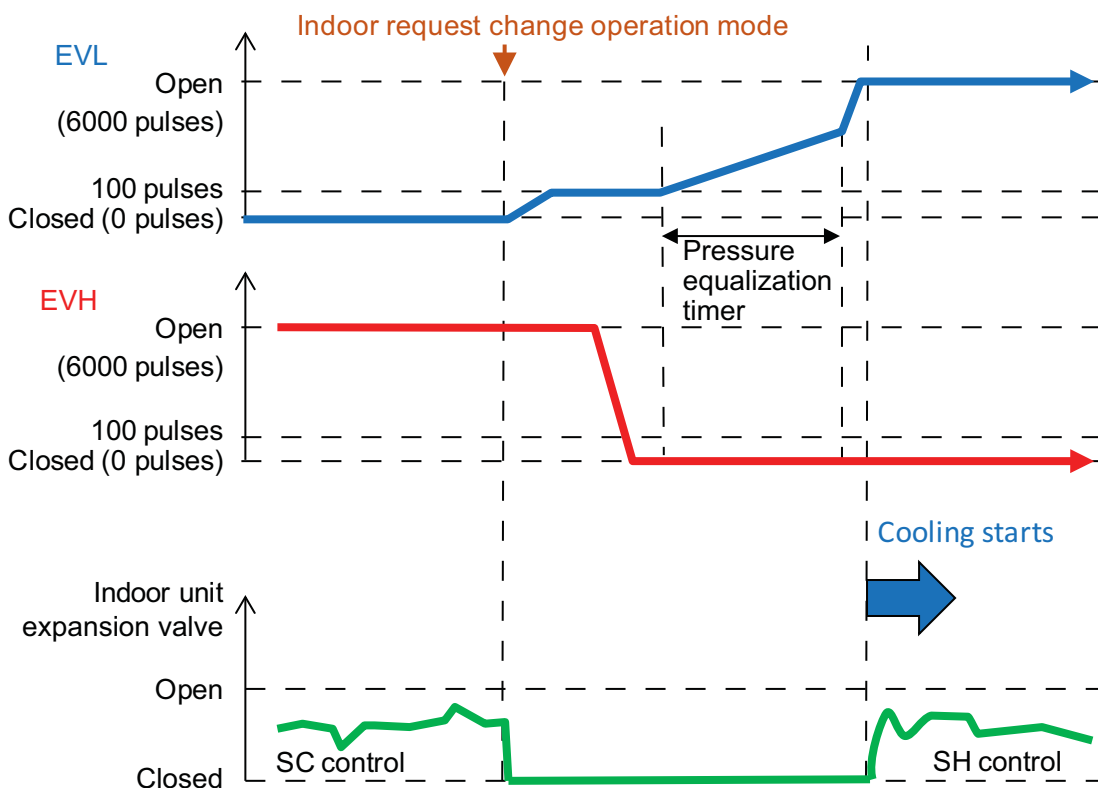

4. General operation of VRV heat recovery system

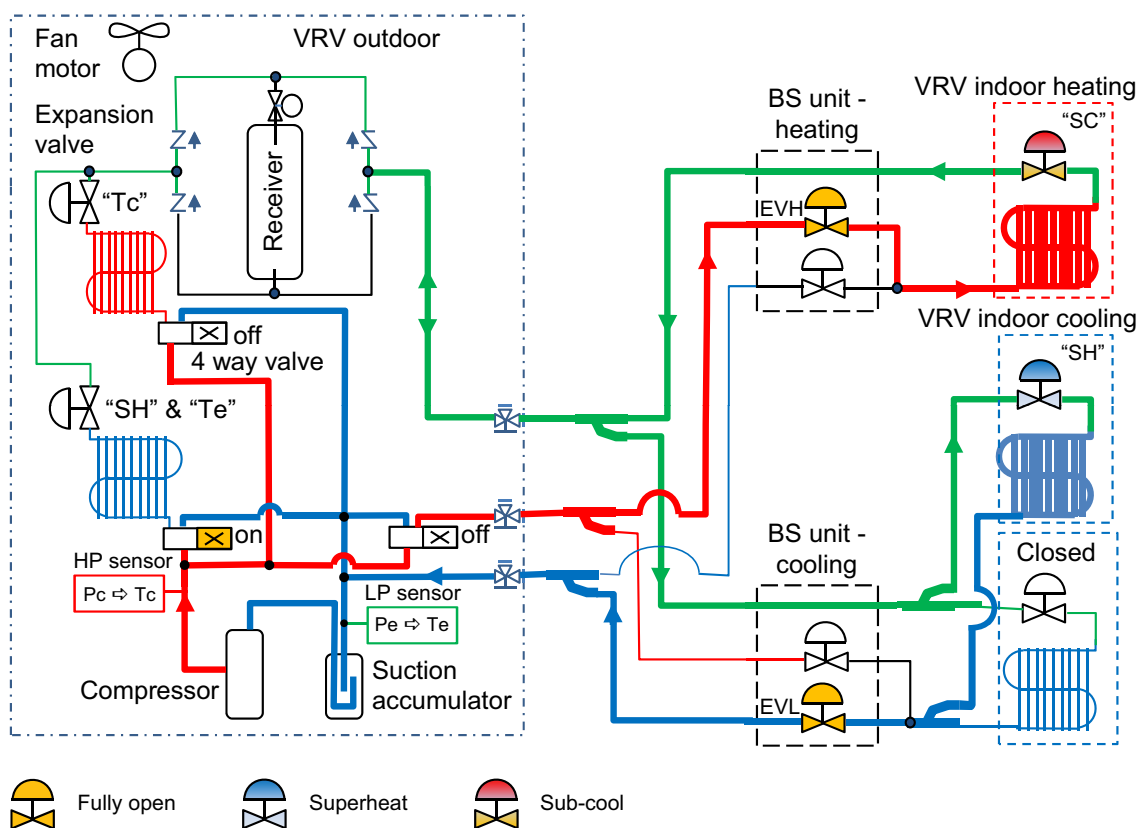

- When indoor unit is selecting heating mode, discharge gas is supplied by the outdoor unit(s) into the dual pressure line through EVH (high pressure expansion valve) fully opened in the BS unit to the indoor unit.
- When indoor unit is selecting cooling mode, suction gas returns from indoor unit gas line through EVL (low pressure expansion valve) fully opened in the BS unit to the outdoor unit.
- Indoor unit in cooling controls the indoor expansion valve on suction superheat (SH) by comparing gas and coil sensor on indoor unit.
- Indoor unit in heating controls the indoor expansion valve on liquid sub-cool (SC) by comparing Tc (outdoor condensing temperature) derived from reading of high pressure sensor, and indoor coil temperature.
- When indoor unit requires change over between cooling and heating, the switching between suction and discharge line is performed only in the BS unit that received the request of indoor unit to change over. Change over sequence is explained in "General built up VRV4 BS unit".
- Outdoor can switch outdoor heat exchanger separately condenser/evaporator in function of unbalance between cooling and heating demand indoor side.

5. How to use this book

5.1. Interactive information flow

This Daikin product Service Manual is intended for professional use only. The actions described hereafter, are only to be performed by qualified and certified persons, taking into account the safety precautions mentioned in this manual and the local regulations as well.

By following the diagram below, the reader can find the relevant information related to his/her task. The digital (pdf) version of this book allows direct page access through all active links. When Adobe Acrobat Reader is used, the <Alt> + <Back Arrow> keys can be used to return to the previously viewed page.

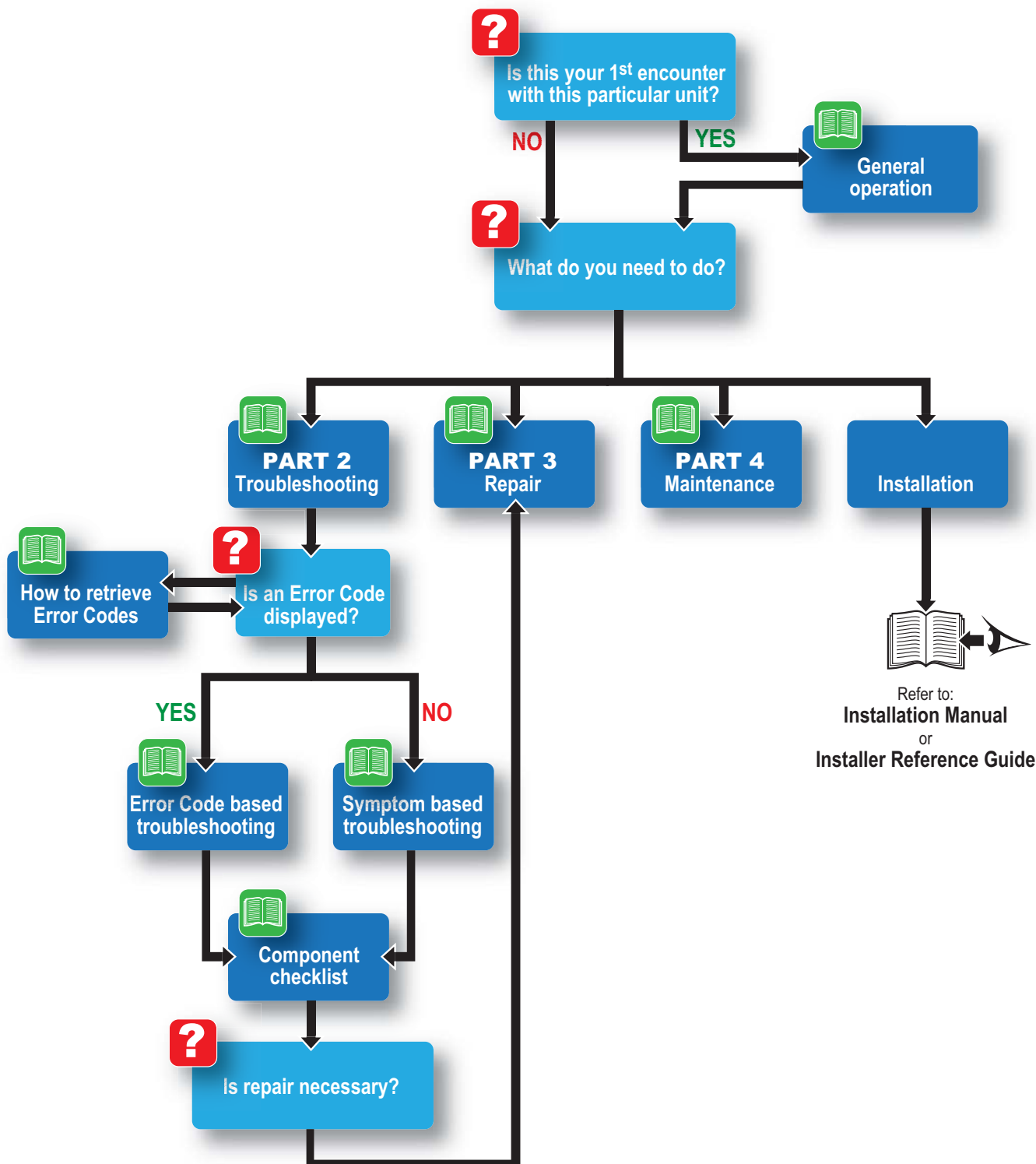

5.2. Parts of the book

This Daikin product Service Manual is intended for professional use only. The actions described hereafter, are only to be performed by qualified and certified persons, taking into account the safety precautions mentioned in this manual and the local regulations as well.

As can be observed from the Table of Contents, this manual is split up into several chapters:

5.2.1. The introduction chapter

The chapter "[Introduction](#)" on [page 9](#) includes the safety precautions, this topic and the general operation description of the product(s) this manual refers to.

5.2.2. The troubleshooting chapter

The chapter "[Troubleshooting](#)" on [page 23](#) not only deals with the methods to recognize and resolve occurring error codes; it also describes the methods how to solve a problem that does not immediately trigger an error code. Such problems are referred to as 'symptom based'. Both the error code based and symptom based troubleshooting tables, indicate possible causes, the necessary checks and in case required, how to repair. The possible causes have been sorted to probability of occurrence and speed of execution.

5.2.3. The repair chapter

The chapter "[Repair](#)" on [page 95](#) handles the removal and replacement of the major components in the product and discusses cleaning methods as well if applicable, such as for filters. Where applicable, refrigerant handling precautions are mentioned for certain actions; please consider these carefully for your own safety.

5.2.4. The maintenance chapter

The chapter "[Maintenance](#)" on [page 195](#) of this manual describes the maintenance intervals and procedures to be performed on the product. Remember that a well maintained product, is a more reliable and efficient product.

5.2.5. Appendices

Finally, the service manual provides in chapter "[Appendix](#)" on [page 207](#) valuable reference data such as piping/wiring diagrams, field settings overview and a checklist to be filled in when you need to escalate an issue to your dealer.

5.3. Contact information

This manual has been made with much care and effort. Use it in your daily jobs, as it has been made for you.

Despite our efforts, there is always a chance some cleric or other mistake has been made during the creation of this manual. We kindly ask you to send the found mistakes, or remarks for improvement, to the no-reply email address servicemanual@daikineurope.com.

Part 2. Troubleshooting

This part contains the following chapters:

1. Error codes23	4. Symptom based troubleshooting 52
2. Error code based troubleshooting25	5. Component checklist..... 53
3. Subcodes.....40	

1. Error codes

1.1. Check for descriptions of malfunctions/retries

Check for descriptions of malfunctions/retries following the procedure described below.

The error codes for forced stop outdoor or retry are item:

- 17, 18, 19: description of malfunction (outdoor system stopped operation)
- 23, 24, 25: description of retry

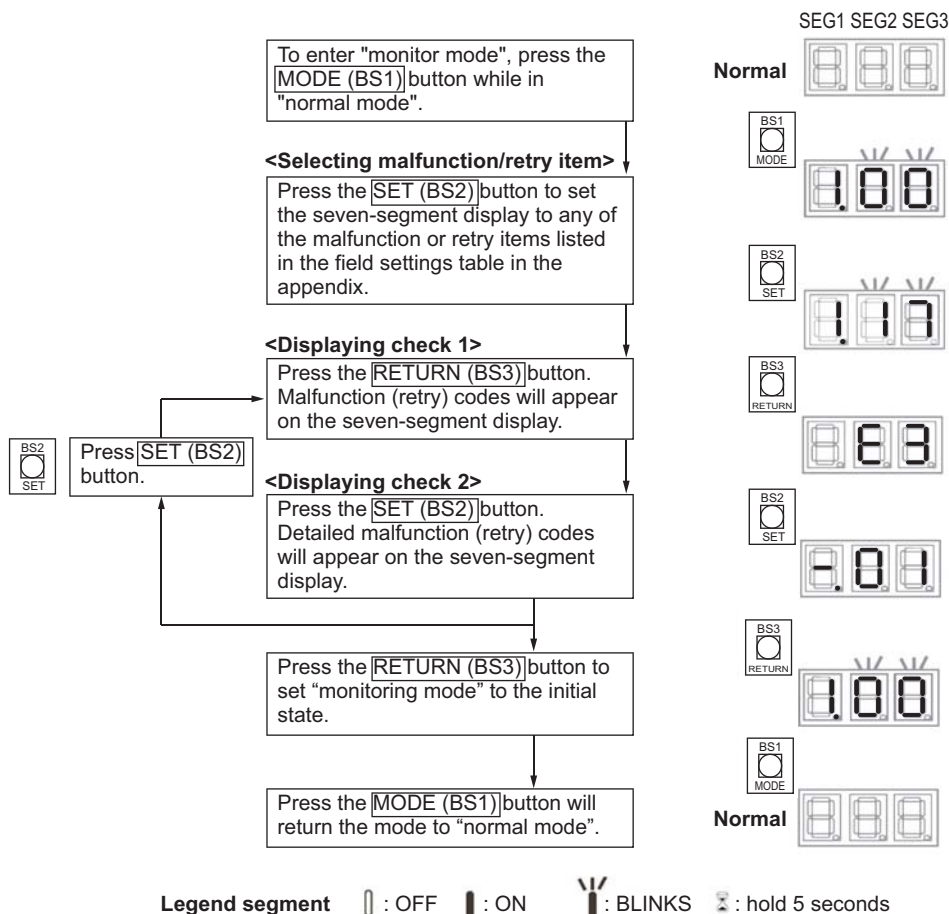

The diagnose display (3) and push buttons (4) are located behind the service plate assembly (1).

To remove the service plate assembly (1), refer to "Removing the service plate assembly" on page 100.

Remove the protective cover (2) to access the display (3) and push buttons (4).

Figure 1 - Diagnose display and push buttons

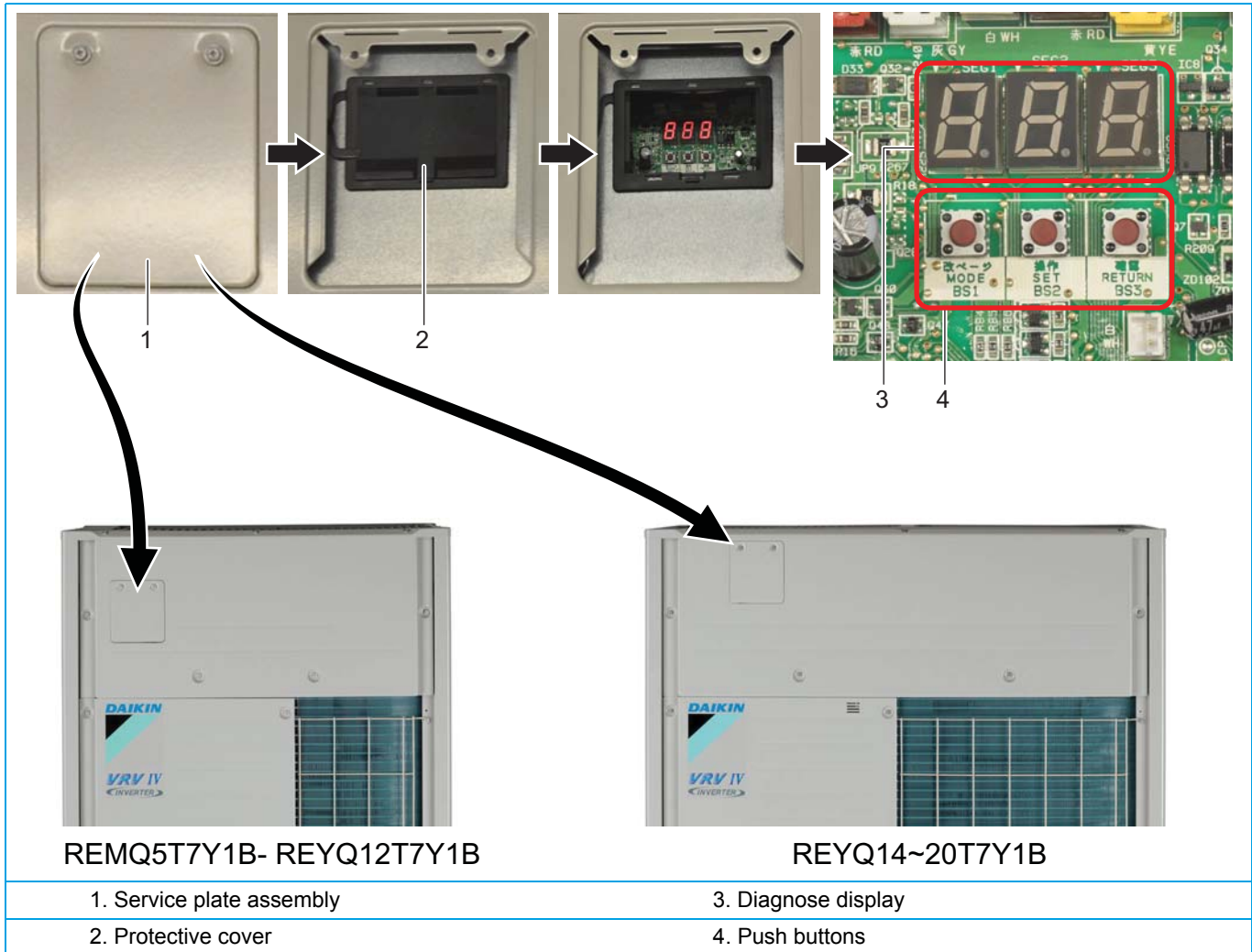

2. Error code based troubleshooting

Overview of error codes:

"E1" – Outdoor main board (A1P) abnormality	25	"P1" – Open phase or power supply voltage imbalance	33	"U1" – Reverse phase or open phase (L3)	33
"E3" – High pressure abnormality	25	"U2" – Power supply inverter circuit abnormality.....	33	"U3" – Test run execution failure	34
"E4" – Abnormal low suction pressure (S1NPL).....	26	"U4" – Communication abnormality between outdoor unit, BS unit and indoor unit	34	"U7" – Communication abnormality between outdoor units	35
"E5" – Compressor motor (M1C, M2C) lock	27	"U9" – Communication abnormality at other unit in same system..	35	"UA" – Compatibility failure detection.....	35
"E7" – Outdoor unit fan motor (M1F, M2F) lock	27	"UF" – Auto address malfunction between outdoor, BS and indoor unit	36	"UH" – Failure of test run outdoor unit.....	36
"E9" – Outdoor unit expansion valve motor (Y1E~Y6E) detection failure.....	28	"P2" – Failure auto-charge function	36	"PE" – Auto-charge function nearly completed	37
"F3" – Abnormal discharge pipe temperature (R21T, R22T, R15T) control	28	"P9" – Auto-charge function completed	37	"E-1" – Refrigerant containment check not possible	37
"F6" – Refrigerant overcharge	29	"E-2" – Refrigerant containment check indoor air temperature out of range.....	37	"E-3" – Refrigerant containment check outdoor air temperature out of range	38
"H9" – Outdoor air thermistor (R1T) abnormality	30	"E-5" – Refrigerant containment check not possible indoor unit not compatible.....	38	"NG" – Refrigerant containment check judges refrigerant leak	38
"J3" – Discharge thermistor (R21T, R22T) or compressor body thermistor (R15T) faulty	30	"OK" – Refrigerant containment check judges no refrigerant leak ..	39		
"J5" – Suction thermistor or compressor body thermistor (R10T, R12T) faulty	30				
"J6" – Outdoor heat exchanger thermistor (R8T, R9T, R11T) faulty.....	30				
"J7" – Liquid thermistor faulty (R3T, R7T).....	31				
"J8" – Heat exchanger thermistor faulty (R4T, R5T) or receiver bypass thermistor "auto-charge" (R14T).....	31				
"J9" – Gas thermistor sub-cool or purge faulty (R6T, R13T).....	31				
"JA" – High pressure sensor (S1NPH) abnormality	31				
"JC" – Low pressure sensor (S1NPL) abnormality	32				
"LC" – Transmission between main board, auxiliary board and inverter boards	32				

2.1. "E1" – Outdoor main board (A1P) abnormality

Trigger	Effect	Reset
PCB A1P detects EEPROM is abnormal.	Unit will stop.	Via remote controller indoor unit.

Possible cause	Check	Corrective action
Faulty PCB A1P.	Check if the service monitor LED HAP blinks in regular intervals (approx. 1Hz).	If not blinking in regular intervals, replace the board A1P (see page 125).
	Check power supply.	Repair faulty part in power supply circuit.
External factor (e.g. electrical noise) (cause when error is reset after power reset, and error happens again after awhile).	Check the source which could cause electrical interference.	Remove source causing electrical interference.

2.2. "E3" – High pressure abnormality

Trigger	Effect	Reset
1. High pressure switch opens due to discharge pressure > 4,0 MPa.	Unit will stop operating.	If field set 2-15-1 (default): via remote controller indoor unit.
2. High pressure sensor detects HP > 3,72 MPa occurs 3 times within 40 minutes.		If field set 2-15-0 (on site): first BS3, followed by remote controller indoor unit.

Possible cause	Check	Corrective action
Refrigerant overcharge.	Check for refrigerant overcharge.	Recover the refrigerant to check amount of refrigerant when error occurred (see page 95).
Humidity in the refrigerant (ice formation in expansion valve).	Check for humidity in the refrigerant.	In case of suspicion of humidity; recover, vacuum and recharge with virgin refrigerant (see page 95).

Non condensables (air or nitrogen) in refrigerant.	Check for non-condensables in refrigerant.	In case of suspicion of non-condensables; recover, vacuum and recharge with virgin refrigerant (see page 95).
Refrigerant circuit is clogged.	Check for possible blockage: measure the refrigerant/pipe temperature. Sudden drop in temperature could indicate blockage (remark: this is not valid for expansion valve).	Repair piping where blockage is found.
Stop valve(s) closed.	Check status of all stop valves (low pressure, high pressure, liquid).	Open all stop valves.
Expansion valve condenser side does not open.	Check if expansion valve opens when control gives output to expansion valve motor.	Replace the expansion valve coil (see page 160) or the expansion valve (see page 164) or PCB A1P (Y1E~Y4E) (see page 125), or PCB A8P (Y5E~Y6E) (see page 128).
Faulty high pressure sensor S1NPH main board A1P.	Check high pressure sensor S1NPH (see page 85).	Replace the high pressure sensor S1NPH (see page 147) or PCB A1P (see page 125).
Faulty high pressure switch S1PH main board A1P.	Check high pressure switch S1PH (see page 89).	Replace the high pressure switch S1PH (see page 149) or PCB A1P (see page 125).
Insufficient air flow rate outdoor in cooling mode.	Check outdoor unit air flow is not obstructed on top.	Add elbow to air outlet to guide air discharge to avoid air short circuit.
Air short circuit outdoor unit in cooling mode.	Check air short circuit is limited. Check air temperature in free air and compare to temperature at inlet heat exchanger.	If difference between free air and air inlet heat exchanger is 5 K or more, improve air outlet. Example by elbow on air outlet (locally produced) might be required.

2.3. “E4” – Abnormal low suction pressure (S1NPL)

Trigger	Effect	Reset
Low pressure sensor S1NPL detects LP < 0,07 MPa 3 times within 60 minutes.	Unit will stop operating.	Via remote controller indoor unit.

Possible cause	Check	Corrective action
Cross piping between systems.	Check by "cross wiring check" method outdoor field set [2-5-1] correct indoor units start fan on H-speed.	Change wiring F1F2-IND between systems cross wiring is found.
Refrigerant shortage.	Check for refrigerant shortage.	Recover the refrigerant to check amount of refrigerant when error occurred (see page 95).
Humidity in the refrigerant (ice formation in expansion valve).	Check for humidity in the refrigerant.	In case of suspicion of humidity; recover, vacuum and recharge with virgin refrigerant (see page 95).
Refrigerant circuit is clogged.	Check for possible blockage. Blockages can be checked by measuring the refrigerant/pipe temperature. Sudden drop in temperature could indicate blockage (remark: this is not valid for expansion valve).	Repair piping where blockage is found.
Stop valve(s) closed.	Check status of all stop valves (low pressure, high pressure, liquid).	Open all stop valves.
Expansion valve (Y1E~Y6E) evaporator side does not open.	Check expansion valve (Y1E~Y6E) opens when control gives output to expansion valve motor.	Replace the expansion valve coil (see page 160) or the expansion valve (see page 164) or PCB A1P (Y1E~Y4E) (see page 125), or PCB A8P (Y5E~Y6E) (see page 128).
Faulty low pressure sensor S1NPL main board A1P.	Check low pressure sensor S1NPL (see page 85).	Replace the high pressure switch S1PH (see page 149) or PCB A1P (see page 125).

Insufficient air flow rate heating.	Check outdoor unit air flow is not obstructed on top.	Improve air inlet to unit.
Air short circuit heating.	If difference between free air and air inlet heat exchanger is 5K or more, improve air outlet. Example by elbow on air outlet (local produced) might be required.	If difference between free air and air inlet heat exchanger is 5K or more, improve air outlet. Example by elbow on air outlet (local produced) might be required.

2.4. “E5” – Compressor motor (M1C, M2C) lock

Trigger	Effect	Reset
The compressor motor start current is too high.	Unit will stop operating.	Via remote controller indoor unit.

Possible cause	Check	Corrective action
Refrigerant circuit is clogged (HP-LP > 0,26 MPa).	Check for possible blockage. Blockages can be checked by measuring the refrigerant/pipe temperature. Sudden drop in temperature could indicate blockage (remark: this is not valid for expansion valve).	Recover the refrigerant to check amount of refrigerant when error occurred (see page 95).
	Check oil return line bottom of oil separator passes through solenoid valve Y11S/12S when energized (when discharge superheat exceeds 15K during compressor operation).	Replace solenoid valve coil (see page 150) or solenoid valve body (see page 159).
Faulty compressor.	Check compressor (refer to subcode to check faulty part) (see page 71).	Replace compressor (see page 169) and also investigate reason of breakdown.
	Check expansion valve operation (liquid back issue).	Replace expansion valve indoor or/and outdoor heat exchanger operating as evaporator can not keep minimum superheat of 3°.
	Check refrigerant shortage (overheated issue), check for leak (see page 95).	Repair leak. Recharge unit after completion of pressure test and vacuuming (see page 95).

2.5. “E7” – Outdoor unit fan motor (M1F, M2F) lock

Trigger	Effect	Reset
Overcurrent detection inverter circuit.	Unit will stop operating after 4 retry fail to operate normal (refer to subcode to check faulty part).	Via remote controller indoor unit.
Malfunction of rotation detection.		

Possible cause	Check	Corrective action
Connectors not connected or loose fan motor wires.	Check if connectors X1A or/and X2A are completely inserted.	Reconnect fan motor connectors X1A or/and X2A (at left side of switchbox).
Fan motor open windings.	Check motor winding (see page 67) (refer to subcode to check faulty part).	Replace fan motor (see page 167) (refer to subcode to check faulty part).
Fan motor rpm detection fails.	Check motor rpm detection.	Replace fan motor (see page 167) (refer to subcode to check faulty part).
Fan motor locked.	Check motor shaft rotates when moved by hand (initially remove connector on X2A on main PCB A1P to avoid start by indoor signal (E3-01 will appear till connector X2A is reconnected)) (see page 67).	If propeller touches bellmouth, verify motor is correctly mounted on the motor base.
		If no mechanical touch, cause is wear of internal bearing, replace fan motor (see page 167).

2.6. “E9” – Outdoor unit expansion valve motor (Y1E~Y6E) detection failure

Trigger	Effect	Reset
When power supply is switched on, main and sub board checks that all expansion valve motors windings are present by current check.	Unit will stop operating.	Power supply reset outdoor.
Low suction superheat when related heat exchanger is evaporator.		

Possible cause	Check	Corrective action
Connectors not connected or wire(s) loose.	Check if connectors are completely inserted (see page 64).	Reconnect connectors on main board and auxiliary board (see page 64).
Expansion valve motor open winding.	Check expansion valve motor winding (refer to subcode to check faulty part) (see page 64).	Replace expansion valve motor (refer to subcode to change faulty part) (see page 164).
Faulty low pressure sensor S1NPL.	Check low pressure sensor (see page 85).	Replace low pressure sensor (see page 147).
Faulty refrigerant gas thermistor.	Check gas thermistor (refer to subcode to check faulty part) (see WELKE THERMISTOR).	Replace gas thermistor (refer to subcode to change faulty part).
A1P board (for Y1E~Y4E) or A8P board (for Y5E~Y6E) faulty.	Check voltage output 12 VDC to coil (refer to subcode to check faulty part) (see page 64).	Replace A1P board (if subcode refers to Y1E to Y4E) (see page 125) or auxiliary board (see page 128) (if subcode refers to Y5E or Y6E).
External factor (e.g. electrical noise): when error is reset after power reset.	Check the source which could cause electrical interference.	Remove source causing electrical interference.

2.7. “F3” – Abnormal discharge pipe temperature (R21T, R22T, R15T) control

Trigger	Effect	Reset
Discharge temperature > 135°C.	Unit will stop operating when discharge temperature or body temperature J-type compressor exceeds 135°C for 2 times within 100 minutes.	Via remote controller indoor unit.
Body temperature > 135°C (if J-type compressor).		

Possible cause	Check	Corrective action
Connectors discharge thermistor or body thermistor not connected.	Check connectors are completely inserted.	Reconnect connectors on main board and auxiliary board.
Discharge temperature is too high.	Check discharge thermistor R21, R22 on pipe and compare with read out in mode 2 (see page 56).	Replace thermistor (refer to subcode to change faulty part) (see page 145).
Stop valve discharge or/and liquid closed.	Check stop valves are fully open.	Open stop valves.
Refrigerant shortage.	Check refrigerant charge (see page 95). Perform leak test function.	In case of suspicion of refrigerant shortage, recover the refrigerant to check amount of refrigerant when error occurred. Compare recovered amount with the calculated additional charge value based on the formula using pipe length of each pipe diameter used in the installation (see page 95).
Faulty discharge thermistor.	Check thermistor (refer to subcode to check faulty part) (see page 56).	Replace thermistor (refer to subcode to change faulty part) (see page 145).

Faulty compressor (internal bypass).	Check the compressor (refer to subcode to check faulty part)	Replace the compressor (refer to subcode to check faulty part) and also investigate reason of breakdown (see page 169).
		Check expansion valves operation (overheated issue) -> check for leak.

2.8. “F6” – Refrigerant overcharge

Trigger	Effect	Reset
During discharge superheat is < 10 K and suction superheat is low while expansion valve(s) evaporator is/are at minimum opening degree.	Outdoor unit keeps running while F6 appears on controllers and outdoor display for warning of refrigerant overcharge.	Power supply reset outdoor.

Possible cause	Check	Corrective action
Refrigerant overcharge.	Check refrigerant charge.	In case of suspicion of refrigerant shortage, recover the refrigerant to check amount of refrigerant when error occurred. Compare recovered amount with the calculated additional charge value based on the formula using pipe length of each pipe diameter used in the installation.
Indoor fan not operating.	Check indoor fan motors are all operating correctly.	Investigate cause indoor fan is not operating.
Indoor air flow blocked.	Check indoor units supply sufficient air flow.	Improve air flow rate, check on obstructions or field setting (in case of duct type unit).
Expansion valve motor or body evaporator faulty.	Check expansion valve coil (see page 61).	Replace expansion valve coil (see page 159) or body (see page 164).
High pressure sensor is faulty.	Check high pressure sensor S1NPH characteristics (see page 89).	Replace high pressure sensor (see page 147).
Discharge pipe thermistor is not faulty.	Check discharge thermistor R21T, R22T characteristics (see page 56).	Replace discharge thermistor (see page 145).
PCB outdoor is faulty.	Check pressure value on outdoor board mode 1 - code 42 and compare with gauge connected to service port liquid stop valve.	Replace PCB A1P (see page 125).

2.9. “H9” – Outdoor air thermistor (R1T) abnormality

Trigger	Effect	Reset
Air thermistor detects an abnormal value (open or short circuit) resulting in respectively -47°C or +99,9°C.	Unit will stop operating.	Auto reset when value returns normal.

Possible cause	Check	Corrective action
Faulty thermistor or AP1 board.	Check thermistor (see page 56).	Replace R1T thermistor (see page 145) or PCB A1P (see page 125).

2.10. “J3” – Discharge thermistor (R21T, R22T) or compressor body thermistor (R15T) faulty

Trigger	Effect	Reset
Thermistor detects an abnormal value (open or closed circuit) resulting in respectively -35°C or 183°C.	Unit will stop operating.	Via remote controller indoor unit.

Possible cause	Check	Corrective action
Faulty discharge thermistor R21T, R22T or compressor body thermistor R15T (J-type compressor) or main board.	Check thermistor R21T, R22T or R15T (see page 56) based on sub-error code and compare with value in mode 1, code 47, 48 and 49.	Replace R21T, R22T or R15T based on sub-error code (see page 145).

2.11. “J5” – Suction thermistor or compressor body thermistor (R10T, R12T) faulty

Trigger	Effect	Reset
Thermistor detects an abnormal value (open or closed circuit) resulting in respectively -47°C or 99,9°C.	Unit will stop operating.	Via remote controller indoor unit.

Possible cause	Check	Corrective action
Faulty suction thermistor R10T (main PCB) or R12T (sub PCB) or PCB (main or auxiliary).	Check thermistor R10T or R12T (see page 56) based on sub-error code.	Replace R10T or R12T based on sub-error code (see page 145).

2.12. “J6” – Outdoor heat exchanger thermistor (R8T, R9T, R11T) faulty

Trigger	Effect	Reset
Thermistor detects an abnormal value (open or closed circuit) resulting in respectively -47°C or 99,9°C.	Unit will stop operating.	Via remote controller indoor unit.

Possible cause	Check	Corrective action
Faulty gas thermistor R8T or R9T (main PCB), or coil thermistor R11T (sub PCB) or faulty PCB (main or auxiliary).	Check thermistor R8T, R9T or R11T (see page 56) based on sub-error code.	Replace thermistor R8T, R9T or R11T (see page 145).

2.13. “J7” – Liquid thermistor faulty (R3T, R7T)

Trigger	Effect	Reset
Thermistor detects an abnormal value (open or closed circuit) resulting in respectively -47°C or 99,9°C.	Unit will stop operating.	Via remote controller indoor unit.

Possible cause	Check	Corrective action
Faulty liquid thermistor R3T or R7T (main PCB) or faulty PCB (main).	Check thermistor R3T or R7T (see page 56) based on sub-error code.	Replace R3T or R7T based on sub-error code (see page 145).

2.14. “J8” – Heat exchanger thermistor faulty (R4T, R5T) or receiver bypass thermistor "auto-charge" (R14T)

Trigger	Effect	Reset
Thermistor detects an abnormal value (open or closed circuit) resulting in respectively -47°C or 99,9°C.	Unit will stop operating.	Via remote controller indoor unit.

Possible cause	Check	Corrective action
Faulty liquid thermistor R4T or R5T (main PCB) or R14T (sub PCB) or PCB (main or auxiliary).	Check thermistor R4T or R5T (see page 56) based on sub-error code.	Replace thermistor R4T, R5T or R14T based on subcode (see page 145).

2.15. “J9” – Gas thermistor sub-cool or purge faulty (R6T, R13T)

Trigger	Effect	Reset
Thermistor detects an abnormal value (open or closed circuit) resulting in respectively -47°C or 99,9°C.	Unit will stop operating.	Via remote controller indoor unit.

Possible cause	Check	Corrective action
Faulty liquid thermistor R6T (main PCB) or R13T (sub PCB).	Check thermistor R6T or R13T (see page 56) based on sub-error code.	Replace thermistor R6T or R13T based on sub-error code (see page 145).

2.16. “JA” – High pressure sensor (S1NPH) abnormality

Trigger	Effect	Reset
High pressure sensor detects an abnormal value for 3 minutes (open circuit < 0,1 MPa or short circuit > 62,1 MPa).	Unit will stop operating.	Via remote controller indoor unit.

Possible cause	Check	Corrective action
Faulty high pressure sensor or faulty main PCB A1P.	Check S1NPH high pressure sensor (see page 85).	Replace S1NPH (see page 147) or PCB A1P (see page 125).

2.17. “JC” – Low pressure sensor (S1NPL) abnormality

Trigger	Effect	Reset
Low pressure sensor detects an abnormal value for 3 minutes (open circuit < 0,1 MPa or short circuit > 25,4 MPa).	Unit will stop operating.	Via remote controller indoor unit.

Possible cause	Check	Corrective action
Faulty low pressure sensor or main PCB "A1P".	Check S1NPL low pressure sensor.	Replace S1NPL (see page 147) or PCB A1P (see page 125).

2.18. “LC” – Transmission between main board, auxiliary board and inverter boards

Trigger	Effect	Reset
Abnormal or no transmission between main board, auxiliary board and inverter boards.	Unit will stop operating.	Via remote controller indoor unit.

Possible cause	Check	Corrective action
Internal wiring is not ok.	Check that the jumper wire (connector X5A) is installed on the last inverter board.	Mount the jumper connector on X5A of last inverter fan board.
Type inverter compressor boards detected different from configuration fixed by horsepower setting.	Incorrect combination inverter boards when mounting spare part.	Mount correct type of inverter board (see page 135 or page 138).
Type inverter fan motor boards detected different from configuration fixed by horsepower setting.	Incorrect horsepower setting spare part main board.	Set dip switches according to instruction sheet delivered with spare part main board (power main board must be disconnected prior to change dip switches).
Faulty main board.	Check main board power supply (see page 54).	If fuse is blown, replace by fuse 3,15 A T-type (slow).
Faulty auxiliary board.	When power supply is (re)connected, service LED HAP on auxiliary board should blink regularly (approx. 1 Hz).	When 16 VDC present and HAP service monitor LED is not blinking, replace auxiliary board (see page 138).
Faulty compressor inverter board.	When power supply is (re)connected, service LED HAP on inverter board compressor should blink regularly (approx. 1 Hz) (refer to subcode to check faulty part).	When 16 VDC present and HAP service monitor LED is not blinking, replace compressor inverter board (see page 135 or page 138).
Faulty fan motor inverter board.	When power supply is (re)connected, service LED HAP on inverter fan motor board should blink regularly (approx. 1 Hz) (refer to subcode to check faulty part).	When 16 VDC present and HAP service monitor LED is not blinking, replace fan motor inverter board (see page 141).
External factor (e.g. electrical noise): when error is reset after power reset.	Check the source which could cause electrical interference.	Remove source causing electrical interference.

2.19. “P1” – Open phase or power supply voltage imbalance

Trigger	Effect	Reset
Inverter board compressor detects incorrect power in the DC circuit (behind diode bridge).	Unit will stop operating.	Auto reset when power in the DC circuit returns normal.

Possible cause	Check	Corrective action
Power supply is not OK -> open phase.	Check the power supply (see page 54).	Restore correct power supply.
Power supply is not OK -> unbalance > 10% (rated power supply: 400 VAC).	Check the power supply for voltage fluctuations (> 10%) (see page 54).	Voltage fluctuations should be less than 10%.
Faulty compressor inverter board (diode bridge or capacitors).	Check inverter board for compressor (refer to subcode to check faulty part) (see page 75).	Replace compressor inverter board (see page 135 or page 138).

2.20. “U1” – Reverse phase or open phase (L3)

Trigger	Effect	Reset
Main board A1P detects incorrect power supply phase sequence between L1 and L3 other than 240°.	Unit will stop operating.	Power supply reset outdoor.

Possible cause	Check	Corrective action
Power supply is not OK -> open phase (L3).	Check power supply phase L1 and L3 present at main board A1P (see page 54).	Inspect circuit breaker in power supply distribution panel of the building.
Power supply is not OK -> reverse phase.	Check the power supply rotation direction L1-L2-L3 by special 3-phase check tool (available on local market).	Change 2 phases sequence on main power supply terminal X1M: L1 & L2 or L2 & L3.
Faulty main board A1P.	Check if fuses F1U and F2U are blown.	Replace main board A1P (see page 125). Check insulation of wires in the unit are not damaged possible resulting in contact with metal parts.

2.21. “U2” – Power supply inverter circuit abnormality

Trigger	Effect	Reset
Inverter board compressor detects voltage in DC circuit (behind diode bridge) can not reach or maintain minimum 500 VDC.	Unit will stop operating.	Power supply reset outdoor.

Possible cause	Check	Corrective action
Power supply is not OK -> imbalance > 10% (rated power supply: 400 VAC).	Check the power supply for voltage fluctuations (> 10%).	Voltage fluctuations should be less than 10%.
Power supply is not OK (neutral missing at inverter board compressor).	Check the power supply from main power supply terminal X1M, through noise filter to terminals L1, L2, L3 compressor inverter PCB (see page 54).	Replace part that interrupts power supply.
Connector loose or loose wire at connector X40A or X41A.	Check connectors correctly mounted and check for loose wires.	Reconnect connector X40A and X41A, reconnect loose wire.
Faulty compressor inverter board.	Check compressor inverter board (refer to subcode to check faulty part) (see page 75).	Replace compressor inverter board (refer to subcode to check faulty part) (see page 135 or page 138).

2.22. "U3" – Test run execution failure

Trigger	Effect	Reset
Prior to normal operation, a test run initiated from outdoor unit is required to verify "cross piping", average field pipe length to indoor units, and total refrigerant amount.	Unit will stop operating.	Test run restarted.

Possible cause	Check	Corrective action
Test run was not started prior to normal operation.		Start test run from outdoor unit.
Test run could not start because initialisation was not completed.	Check communication is initialised prior to launch testrun.	Restart test run from outdoor unit.
Test run was interrupted manually by pressing BS1 "Mode" button.		Restart test run from outdoor unit.
Test run was interrupted by safety device.	Check error history outdoor unit.	Follow troubleshooting according to error code.

2.23. "U4" – Communication abnormality between outdoor unit, BS unit and indoor unit

Trigger	Effect	Reset
Main control board A1P detects abnormal transmission to BS unit board or/and indoor unit board.	Unit will stop operating.	Auto reset when communication resumes to normal.

Possible cause	Check	Corrective action
Power supply phase L1 is too low -> minimum required voltage 345 VAC.	Check the power supply phase L1 exceeds 345 VAC (see page 54).	Voltage fluctuations should be less than 10% of voltage range 380-415 VAC.
Field wiring between outdoor main board and BS unit board or/and indoor board is loose.	Check field wiring is firmly fixed at terminals of BS unit and indoor unit.	Restart test run from outdoor unit.
Power supply to some BS unit or indoor unit is interrupted since initialisation was completed.	Check number of indoor unit and BS unit from last initialisation (mode 1 - code 10) for indoor units, code 11 for BS units.	Restore power supply to indoor units that are connected to related BS unit.
	Start indoor units to forced fan operation (mode 2 - code 5 - set 1) and verify number of indoor units operating on high fan speed.	Restore power supply to indoor units that are connected to related BS unit.
Communication problem between outdoor modules connected by Q1Q2 wiring.	Check voltage on Q1Q2 terminals between modules.	If voltage on Q1Q2 terminals is approx. 0 VAC, replace outdoor A1P board (see page 125).
Faulty main control board.	Start a re-initialisation. Within 60 seconds, voltage on F1F2 should read approx. 16 VDC. Refer to "Check communication".	Replace outdoor A1P board if voltage at terminals F1F2 remains around 0 VDC after initialisation was started (see page 125).
Faulty board BS unit.	After initialisation is finished (outdoor display off) check voltage F1F2 indoor approx. 16 VDC.	If voltage at terminals F1F2 BS unit is correct, replace BS unit control board (see page 179).
Faulty board indoor unit.	After initialisation is finished (outdoor display off) check voltage F1F2 indoor approx. 16 VDC. Check by indoor remote controller outdoor unit is recognized.	Replace indoor board when outdoor unit is not recognized when outdoor unit finished initialisation.
External factor (e.g. electrical noise): when error is reset after power reset.	Check the source which could cause electrical interference.	Reduce/suppress electrical noise.

2.24. “U7” – Communication abnormality between outdoor units

Trigger	Effect	Reset
Main control board A1P detects abnormal transmission between other outdoor units in same system (Q1Q2 terminals) or belonging to other system (F1F2 OUT/D unit).	Unit will stop operating.	Auto reset when communication resumes to normal.

Possible cause	Check	Corrective action
Too many indoor units connected to F1F2 communication bus.	Check the total number of indoor units connected to this system and across all systems connected by "F1F2 OUT/D UNIT" terminals: per system maximum 64, all systems together: maximum 128.	Split number of systems or remove indoor units from system (refrigerant recovery will be necessary to remove from refrigerant circuit).
Incorrect wiring between modules in multi-unit configuration.	Only 1 module should have connection to BS units ("F1F2 IN/D UNIT") and other systems ("F1F2 OUT/D UNIT").	Change field wiring so that per system, only 1 module has field wiring at terminals "F1F2 IN/D UNIT" and "F1F2 OUT/D unit".
Low noise operation or/and demand control is active without presence of optional board DTA104A61/62.	Check field setting 2-12.	Only use field setting 2-12-1 when DTA104A61/62 is actually present in the F1F2 field wiring.

2.25. “U9” – Communication abnormality at other unit in same system

Trigger	Effect	Reset
When some other BS unit or/and indoor unit shows an error UA, A1, A9, or F9 error.	Unit will stop operating.	Auto reset when communication resumes normal.

Possible cause	Check	Corrective action
Some indoor unit or BS unit is not compatible to detected outdoor unit.	Check type of BS unit and indoor unit showing error UA.	Eliminate error code on unit showing error code UA.
Some indoor unit can not operate in the system.	Check error code on indoor units showing error code other than U9.	Eliminate error code on unit showing error code other than U9.

2.26. “UA” – Compatibility failure detection

Trigger	Effect	Reset
When system is initialised, outdoor unit main board checks detected BS unit(s) and indoor unit(s) are compatible to this type of unit.	Unit will stop operating.	Auto reset when only compatible indoor units and supported combinations are detected after initialisation is finished.

Possible cause	Check	Corrective action
Some indoor unit or BS unit is not compatible with detected outdoor unit.	Check type of BS unit and indoor unit showing error UA.	Eliminate error code on unit showing error code UA.
Wrong type outdoor units for multi combination.	Check model name of outdoor unit(s) and verify if current combination is according to the combination table (see installation manual and data book).	Change outdoor unit(s) to have correct combination. Refrigerant recovery will be required before change is started.
No BS units detected by outdoor.	Check on board of BS unit service monitor LED should blink regularly, approx. 1 Hz.	Change board of BS unit if LED is not blinking when power supply is confirmed (see page 179).

Incorrect dip switch setting BS unit.	Check position of dip switch on board(s) in BS unit are according to number of connected indoor units (in case of multi BS unit).	Change dip switches on board(s) of BS unit when power is disconnected of BS unit. After switching on power supply, re-initialisation from outdoor main board is required.
---------------------------------------	-----------------------------------------------------------------------------------------------------------------------------------	---------------------------------------------------------------------------------------------------------------------------------------------------------------------------

2.27. “UF” – Auto address malfunction between outdoor, BS and indoor unit

Trigger	Effect	Reset
During test run outdoor, if check fails on cross piping, closed stop valve(s), or freeze up indoor occurs.	Unit will stop operating.	Test run must be restarted.

Possible cause	Check	Corrective action
Field piping is crossed between systems.	Check for which indoor unit coil temperature did not drop during test run: use BRC1E controller: Maintenance menu - sensor address - code 2.	Verify field piping on blockage or restriction. Verify correct connections between outdoor, BS unit and indoor unit.
Some stop valve is closed.	Check status of all stop valve.	Fully open all stop valves.
Indoor unit(s) enter freeze-up protection.	Indoor fan motor can operate.	Repair indoor unit if fan motor can not operate correctly.

2.28. “UH” – Failure of test run outdoor unit

Trigger	Effect	Reset
During initialisation, auto addressing indoor units by outdoor PCB failed.	Unit will stop operating.	Re-initialisation outdoor is required.

Possible cause	Check	Corrective action
Communication interrupted between outdoor, BS and indoor unit.	Check if indoor unit received address from outdoor: use BRC1E controller: Maintenance menu - sensor address - code 4.	Perform a reset of communication on outdoor main board. Wait till outdoor display goes off before restarting.

2.29. “P2” – Failure auto-charge function

Trigger	Effect	Reset
An abnormality occurs during auto-charge.	Unit will stop operating.	Auto-charge must be restarted.

Possible cause	Check	Corrective action
At step "t03" blinking, BS2 "Set" was not pressed within 5 minutes.	Check display during auto-charge, when outdoor display indicates "t03" blinking: 1. open valve of external refrigerant cylinder, and 2. press button BS2 "Set" refrigerant cylinder.	Restart the auto-charge function and follow procedure as described in the installation manual of outdoor unit "to charge refrigerant: flow chart".

2.30. “PE” – Auto-charge function nearly completed

Trigger	Effect	Reset
When the auto-charge function judges liquid sub-cool is nearly target sub-cool.	Keeps running. PE is a caution, not a fault.	No reset required, PE is a caution, not an error.

Possible cause	Check	Corrective action
Liquid sub-cool is nearly target sub-cool.	Check by balance there is still sufficient refrigerant in the external refrigerant cylinder.	When external refrigerant cylinder is nearly empty, replace by other cylinder with some refrigerant remaining.

2.31. “P9” – Auto-charge function completed

Trigger	Effect	Reset
When the auto-charge function judges liquid sub-cool reached target sub-cool.	Unit will stop operating.	No reset required, P9 is a caution, not an error.

Possible cause	Check	Corrective action
Liquid sub-cool reached target sub-cool.	Check all valves are closed between manifold, service ports and external refrigerant cylinder.	<ol style="list-style-type: none"> 1. Remove manifold from auto-charge port. 2. Input the additional refrigerant amount at field setting 2-15. 3. Launch test run.

2.32. “E-1” – Refrigerant containment check not possible

Trigger	Effect	Reset
Total refrigerant judgment unknown.	Unit will stop operating.	Via remote controller indoor unit.

Possible cause	Check	Corrective action
Additional charge input unknown.	Field setting 2-14.	Field setting 2-14 setting must be higher than 0 (default).
Long test run not performed.	Field setting 2-88.	Make field setting 2-88-0 (default) = enable calculation of total refrigerant charge during prolonged test run by outdoor unit.
Test run was interrupted.	Check error history outdoor.	Perform troubleshooting by error code based on error code found in mode 1 (code 17, 18, 19).

2.33. “E-2” – Refrigerant containment check indoor air temperature out of range

Trigger	Effect	Reset
Average indoor air temperature below 15°C.	Unit will not start the refrigerant containment check.	Average indoor air temperature must be above 15°C.

Possible cause	Check	Corrective action
Indoor air temperature is too low due to winter season.	Check air temperature indoor units to be above +15°C.	Perform a new refrigerant containment check when average indoor air temperature is over 15°C (see page 95).

2.34. “E-3” – Refrigerant containment check outdoor air temperature out of range

Trigger	Effect	Reset
Outdoor air temperature is below 20°C.	Outdoor unit will not start the refrigerant containment check.	Outdoor air temperature must be above 20°C.

Possible cause	Check	Corrective action
Outdoor air temperature is too low due to winter season.	Check outdoor air temperature measured by outdoor unit(s) must be above +20°C.	Perform a new refrigerant containment check when average outdoor air temperature is over 20°C (see page 95).

2.35. “E-5” – Refrigerant containment check not possible indoor unit not compatible

Trigger	Effect	Reset
Outdoor unit detects combination of VRV indoor and hydrobox.	Outdoor unit will not start the refrigerant containment check.	Hydrobox unit(s) must be disconnected.

Possible cause	Check	Corrective action
Hydrobox unit(s) detected in the communication between outdoor and BS units.	Check presence of hydrobox units: mode 1 - code 39. Value should show 0 (zero).	If refrigerant containment check is required by customer, hydrobox unit(s) must be disconnected. Refrigerant recovery will be required before disconnecting the hydrobox unit(s).
		If refrigerant recovery is not required by customer, system can be operated without executing the refrigerant containment check.

2.36. “NG” – Refrigerant containment check judges refrigerant leak

Trigger	Effect	Reset
Result of refrigerant containment check is more than 15% offset compared to result of test-run.	Result of refrigerant containment check is stored into mode 1 - code 29, 30 and 31 (result of last 3 refrigerant containment checks).	No reset required.

Possible cause	Check	Corrective action
Refrigerant leak occurred.	Check for refrigerant leak: look for oil traces on field piping, outdoor and indoor. Recover the refrigerant and perform an air tight test by dry nitrogen at 4,0MPa for 24 hours.	Recover the refrigerant, repair the leak, perform an air tight test by dry nitrogen at 4,0MPa for 24 hours, charge the system and perform a new test-run. (see page 95). Update the logbook.
Indoor and/or outdoor temperature of previous test-run are completely different from last leak-test	Verify Logbook to find out conditions at time of auto-charge.	Perform a new leak-test when indoor and outdoor temperature are in same range when last test run was performed.
Indoor unit lay out changed since last test-run was performed.	Check current lay out of indoor units.	Perform a new test-run to store refrigerant containment value before next refrigerant containment check is planned (see page 95). Update the logbook.

2.37. "OK" – Refrigerant containment check judges no refrigerant leak

Trigger	Effect	Reset
Offset of result of refrigerant containment check compared to data of last performed test-run was less than 15% of total charge weight calculated at the end of test-run kg.	Unit can operate normally.	No reset required.

Possible cause	Check	Corrective action
Refrigerant leak amount detected is less than 15% of total refrigerant charge calculated at the end of the test-run.	Check general performance of system (HP, LP, frequency, discharge temperature) by mode 1 - code 42~49.	If any trace of oil is found at welding or flare connection, recover and weight the refrigerant. Repair the leak, pressure test by nitrogen to 4.0 MPa and re-charge system with the total charge mentioned on the refrigerant charge sticker.

3. Subcodes

3.1. Error codes related to BS..Q..A

Main	Sub error code			Status outdoor	Reset	Cause	Solution
Error	Main	Sub1	Sub2				
A3	01			Forced stop	Auto recovery	BS box control board faulty	Check power to BS unit board, check LED "HAP" is blinking, change control board (see page 179).
F9	01			Forced stop	Power reset BS unit	Coil Y2E (EVH) BS unit open circuit	Check winding expansion valve coil Y2E (gas HP) in BS unit connected to indoor showing error.
	02			Forced stop	Power reset BS unit	Coil Y3E (EVL) BS unit open circuit	Check winding expansion valve coil Y3E (gas LP) in BS unit connected to indoor showing error.
	05			Forced stop	Power reset BS unit	Coil Y1E (EVSC) BS unit open circuit	Check winding expansion valve coil Y1E (liquid sub-cool) in BS unit connected to indoor showing error.

3.2. Error codes related to REMQ5T7Y1B, REYQ8~20T7Y1B

Main	Sub error code			Status outdoor	Reset	Cause	Solution
Error	Main	Sub1	Sub2				
E1	1			Forced stop	BRC...	Main board abnormality	Check power supply stable (see page 54).
	2					Main board defect	Replace board A1P (see page 125).
E2	01	02	03	Forced stop	BRC...	Earth leak detection	Repair part causing earth leakage.
	06	07	08	Forced stop	BRC...	Open circuit detection	Re-connect device.
E3	01	03	05	Forced stop	BRC...	HP switch opened	Check cause HP actuation.
	02	04	06	Forced stop	BRC...	HP gas check test run	Open stop valves, check refrigerant charge.
	13	14	15	Forced stop	BRC...	HP liquid check test run	Open stop valve(s).
	07			Forced stop	BRC...	HP switch no reset	Check pressure switch status.
	18			Forced stop	BRC...	HP switch opened test run	Open stop valves, check refrigerant charge.
	20	21	22	Forced stop	BRC...	X4A input open (default jumper)	Add jumper connector to X4a.
E4	01	02	03	Forced stop	BRC...	Lpsens detects below 0,07 MPa during operation	Check cause of abnormal low pressure during operation.
E5	1	2	3	Forced stop	BRC...	Inverter compressor nr. 1 lock	Check compressor nr. 1 motor winding (see page 71).
	7	8	9	Forced stop	BRC...	Inverter compressor nr. 2 lock	Check compressor nr. 2 motor winding (see page 71).

Main	Sub error code			Status outdoor	Reset	Cause	Solution
Error	Main	Sub1	Sub2				
E6	11	13	16	Forced stop	BRC...	fan inverter nr.1 no rpm detection	Replace inverter board compressor nr.1 (see page 75).
	12	14	16	Forced stop	BRC...	fan inverter nr.2 no rpm detection	Replace inverter board compressor nr.2 (see page 75).
	17	19	21	Forced stop	BRC...	inverter board compressor nr. 1 damaged	Replace inverter board compressor nr.1 (see page 75).
	18	20	22	Forced stop	BRC...	inverter board compressor nr. 2 damaged	Replace inverter board compressor nr.2 (see page 75).
E7	1	13	25	Forced stop	BRC...	Fan inverter nr. 1 no rpm detection	Check fan motor nr. 1 rpm signals (see page 67), connectors correctly mounted
	2	14	26	Forced stop	BRC...	Fan inverter nr. 2 no rpm detection	Check fan motor nr. 2 rpm signals (see page 67), connectors correctly mounted
	5	17	29	Forced stop	BRC...	Fan inverter nr. 1 overcurrent	Check motor windings fan motor nr. 1(see page 67).
	6	18	30	Forced stop	BRC...	Fan inverter nr. 2 overcurrent	Check motor windings fan motor nr. 2 (see page 67).
	9	21	33	Forced stop	BRC...	Fan inverter nr. 1 overheat	Check contact radiant cooler
	10	22	34	Forced stop	BRC...	Fan inverter nr. 2 overheat	Check contact radiant cooler
E9	01	05	08	Forced stop	Power reset	Coil Y1E (upper heat exchanger) open circuit	Check winding expansion valve coil Y1E (see page 64). Replace coil (see page 160) or main board (see page 125).
	03	06	09	Forced stop	Power reset	Coil Y2E (liquid sub-cool) open circuit	Check winding expansion valve coil Y2E (see page 64). Replace coil (see page 162) or main board (see page 125).
	04	07	10	Forced stop	Power reset	Coil Y3E (middle heat exchanger) open circuit	Check winding expansion valve coil Y3E (see page 64). Replace coil (see page 160) or main board (see page 125).
	20	21	22	Forced stop	Power reset	Detection failure Y1E	Check winding expansion valve coil Y1E (see page 64). Replace coil (see page 160) or main board (see page 125).
	23	24	25	Forced stop	Power reset	Detection failure Y2E	Check winding expansion valve coil Y2E (see page 64). Replace coil (see page 162) or main board (see page 125).
	26	27	28	Forced stop	Power reset	Coil Y4E (purge receiver) open circuit	Check winding expansion valve coil Y4E (see page 64). Replace coil (see page 160) or main board (see page 125).
	29	34	39	Forced stop	Power reset	Coil Y5E (radiant cooler) open circuit	Check winding expansion valve coil Y5E (see page 64). Replace coil (see page 162) or main board (see page 125).
	31	36	41	Forced stop	Power reset	Coil Y6E (bypass receiver auto-charge) open circuit	Check winding expansion valve coil Y6E (see page 64). Replace coil (see page 160) or main board (see page 125).

Main	Sub error code			Status outdoor	Reset	Cause	Solution
	Error	Main	Sub1				
E9	44	45	46	Forced stop	Power reset	Detection failure Y2E	Check winding expansion valve coil Y3E (see page 64). Replace coil (see page 160) or main board (see page 125).
F3	01	03	05	Forced stop	BRC...	High compressor discharge temperature	Check discharge thermistors (see page 56), operation expansion valves, refrigerant charge (see page 95).
	02	04	06	Forced stop	BRC...	Cross gas pipes at BS unit	Change field pipe connections
	20	21	22	Forced stop	BRC...	High compressor body temperature (only J-type compressor)	Check discharge thermistors (see page 56), operation expansion valves, refrigerant charge (see page 95).
F4	01			Forced stop	BRC...	Liquid back alarm	Verify heat exchange efficiency.
	02	04	06	Operation possible		Liquid back alarm Inverter compressor 1	Verify following sensors: R21T (see page 56), S1NPH (see page 85), Y1E (see page 64), Y3E (see page 64); replace if faulty.
	03	05	07	Operation possible		Liquid back alarm Inverter compressor 2	Verify following sensors: R22T (see page 56), S1NPH (see page 85), Y1E (see page 64), Y3E (see page 64); replace if faulty.
	08	10	12	Forced stop		Liquid back abnormal Inverter compressor 1	Verify following sensors: R21T (see page 56), S1NPH (see page 85), Y1E (see page 64), Y3E (see page 64); replace if faulty.
	09	11	13	Forced stop		Liquid back abnormal Inverter compressor 2	Verify following sensors: R22T (see page 56), S1NPH (see page 85), Y1E (see page 64), Y3E (see page 64); replace if faulty.
F6	01			Forced stop		Refrigerant overcharge by high pressure sensor	Verify refrigerant charge
	02			Forced stop	BRC...	High sub-cool heat exchanger	Verify refrigerant charge (see page 95).
	03					Refrigerant overcharge by high sub-cool	Verify following sensors: R3T (see page 56), S1NPH (see page 85); replace if faulty. Verify refrigerant charge
H3	2	4	6	Forced stop	BRC...	Connection malfunction main board - inverter nr. 1	Check communication main board to inverter PCB compressor nr. 1
	3	5	7	Forced stop	BRC...	Connection malfunction main board - inverter nr. 2	Check communication main board to inverter PCB compressor nr. 2
H7	1	5	9	Forced stop	BRC...	Fan inverter nr. 1 no rpm detection	Check rpm detection signal fan motor nr. 2 (see page 67).
	2	6	10	Forced stop	BRC...	Fan inverter nr. 2 no rpm detection	Check rpm detection signal fan motor nr. 1 (see page 67).
H9	1	2	3	Forced stop	Auto recovery	Outdoor air sensor out of range (open or short circuit)	Check connector air sensor to main board, check resistance air sensor (see page 56).
HA				Alarm	Auto recovery	Defrost fail alarm	Check air circulation outdoor, refrigerant charge, coil sensor outdoor, HP pressure sensor.

Main	Sub error code			Status outdoor	Reset	Cause	Solution
Error	Main	Sub1	Sub2				
J3	16	22	28	Forced stop	BRC...	Discharge thermistor R21T (compressor nr. 1) open circuit	Check connector X19A main board: discharge sensor R21T (see page 56), check resistance discharge sensor.
	17	23	29	Forced stop	BRC...	Discharge thermistor R21T (compressor nr. 1) short	Check resistance discharge sensor R21T (see page 56).
	18	24	30	Forced stop	BRC...	Discharge thermistor R22T (compressor nr. 2) open circuit	Check connector X19A main board: discharge sensor R22T (see page 56), check resistance discharge sensor.
	19	25	31	Forced stop	BRC...	Discharge thermistor R22T (compressor nr. 1) open circuit	Check connector X19A main board: discharge sensor R22T (see page 56), check resistance discharge sensor.
	47	49	51	Forced stop	BRC...	Body thermistor R15T (J-type compressor) open circuit	Check connector X19A main board: body thermistor R15T (see page 56), check resistance body thermistor.
	48	50	52	Forced stop	BRC...	Body thermistor R15T (J-type compressor) short	Check resistance body thermistor R15T (see page 56).
	56	57	58	Warning	Auto recovery	High discharge temperature	Check resistance discharge thermistor R21T and R22T (see page 56), expansion valves operation, refrigerant charge.
	59	60	61	Warning	Auto recovery	Discharge thermistor reverse detection nr. 1 & 2	
J5	01	03	05	Forced stop	Auto recovery	R12T thermistor suction compressor open or closed	Check connector X15A sub-board suction thermistor R12T to main board, check resistance suction thermistor (see page 56).
	18	19	20	Forced stop	Auto recovery	R10T thermistor suction gas indoor cooling open or closed	Check connector X29A main board suction thermistor R10T to main board, check resistance suction thermistor (see page 56).
J6	01	02	03	Forced stop	Auto recovery	R11 thermistor coil middle coil open or closed	Check connector X15A sub board: coil thermistor R11T, check resistance coil thermistor (see page 56).
	08	09	10	Forced stop	Auto recovery	R8T thermistor gas upper coil open or closed	Check connector X29A main board: gas thermistor R8T, check resistance gas thermistor (see page 56).
	11	12	13	Forced stop	Auto recovery	R9T thermistor gas middle coil open or closed	Check connector X29A main board: suction thermistor R9T, check resistance gas thermistor (see page 56).
J7	01	02	03	Forced stop	Auto recovery	R3T thermistor liquid inlet receiver open or closed	Check connector X30 main PCB: liquid thermistor R3T, check resistance liquid thermistor (see page 56).
	06	07	08	Forced stop	Auto recovery	R7T thermistor liquid at liquid stop valve, open or closed	Check connector X30A main PCB: liquid thermistor R7T, check resistance liquid thermistor (see page 56).
	17						

Main	Sub error code			Status outdoor	Reset	Cause	Solution
	Error	Main	Sub1				
J8	01	02	03	Forced stop	Auto recovery	R4T main liquid upper coil open or closed	Check connector X30A main PCB liquid thermistor R4T, check resistance liquid thermistor (see page 56).
	08	09	10	Forced stop	Auto recovery	R5T main liquid middle coil open or closed	Check connector X30A main PCB liquid thermistor R5T, check resistance liquid thermistor (see page 56).
	11	12	13	Forced stop	Auto recovery	R14T bypass receiver, open or closed	Check connector X15A sub board: liquid thermistor R14T, check resistance liquid thermistor (see page 56).
J9	01	02	03	Forced stop	Auto recovery	R6T gas outlet sub-cool circuit, open or closed	Check connector X30A main board: gas thermistor R6T (see page 56), check resistance gas thermistor.
	08	09	10	Forced stop	Auto recovery	R6T thermistor temperature out of range	Check connector X30A main board: gas thermistor R6T (see page 56), check resistance gas thermistor.
	11	12	13	Forced stop	Auto recovery	R13T gas purge receiver, open or closed	Check connector X17A sub board: gas thermistor R13T (see page 56), check resistance gas thermistor.
JA	06	08	10	Forced stop	BRC...	S1NPH high pressure sensor open circuit	Check connector X32A main board: high pressure sensor S1NPH (see page 85), check voltage signal high pressure sensor.
	07	09	11	Forced stop	BRC...	S1NPH high pressure sensor closed circuit	Check connector X32A main board: high pressure sensor S1NPH (see page 85), check voltage signal high pressure sensor.
JC	06	08	10	Forced stop	BRC...	S1NPL low pressure sensor open circuit	Check connector X31A main board: low pressure sensor S1NLH (see page 85), check voltage signal low pressure sensor.
	07	09	11	Forced stop	BRC...	S1NPL low pressure sensor closed circuit	Check connector X31A main board: low pressure sensor S1NLH (see page 85), check voltage signal low pressure sensor.

Main	Sub error code			Status outdoor	Reset	Cause	Solution
	Error	Main	Sub1				
L1	1	7	11	Forced stop	BRC...	Inverter PCB A3P malfunction	Replace inverter board A3P (see page 75).
	2	8	12	Forced stop	BRC...	PCB A3P current detection primary circuit	Check possible causes overcurrent inverter circuit compressor nr. 1.
	3	9	13	Forced stop	BRC...	PCB A3P current detection secondary circuit	Check possible causes overcurrent inverter circuit compressor nr. 1.
	4	10	14	Forced stop	BRC...	PCB A3P transistor error	Power transistor check, replace inverter board A3P (see page 75).
	5	15	16	Forced stop	BRC...	PCB A3P hardware fault	Replace inverter board A3P (see page 75)
	17	22	42	Forced stop	BRC...	Inverter PCB A6P malfunction	Replace inverter board A6P (see page 75) or compressor nr. 2 (see page 169).
	18	23	43	Forced stop	BRC...	PCB A6P current detection primary circuit	Replace inverter board compr. nr. 2 (see page 75) or compressor nr. 2 (see page 169).
	19	24	44	Forced stop	BRC...	PCB A6P current detection secondary circuit	Replace inverter board compr. nr. 2 (see page 75) or compressor nr. 2 (see page 169).
	20	25	45	Forced stop	BRC...	PCB A6P transistor error	Power transistor check, replace inverter PCB A6P (see page 75).
	21	26	46	Forced stop	BRC...	PCB A6P hardware fault	Replace inverter board A6P (see page 75).
	28	32	34	Forced stop	BRC...	PCB A4P EEPROM fault	Replace inverter board A4P (see page 75).
	29	33	35	Forced stop	BRC...	PCB A7P EEPROM fault	Replace inverter board A7P (see page 75).
	36	38	40	Forced stop	BRC...	PCB A3P EEPROM fault	Replace inverter board A3P (see page 75).
	37	39	41	Forced stop	BRC...	PCB A6P EEPROM fault	Replace inverter board A6P (see page 75).
	47	49	51	Forced stop	BRC...	PCB A3P 16 VDC abnormal, check voltage A3P.	Replace inverter board A3P (see page 75).
48	50	52	Forced stop	BRC...	PCB A6P 16 VDC abnormal, Check voltage A6P.	Replace inverter board A6P (see page 75).	
L2	01	02	03	Warning	Power reset outdoor	50 Hz zero crossing error during test-run	Adjust power supply quality frequency 50 Hz \pm 3%.
	04	05	06	Warning	Power reset outdoor	50 Hz zero crossing error during normal operation	Adjust power supply quality frequency 50 Hz \pm 3%.
L4	01	02	03	Forced stop	BRC...	PCB A3P high fin temperature	Check contact cooling tube switchbox, check radiant cool circuit.
	9	10	11	Forced stop	BRC...	PCB A6P high fin temperature	Check contact cooling tube switchbox, check radiant cool circuit.
L5	3	5	7	Forced stop	BRC...	PCB A3P short circuit current	Check inverter circuit compressor nr. 1 (see page 75).
	14	15	16	Forced stop	BRC...	PCB A6P short circuit current	Check inverter circuit compressor nr. 2 (see page 75).

Main	Sub error code			Status outdoor	Reset	Cause	Solution
	Error	Main	Sub1				
L8	3	6	7	Forced stop	BRC...	PCB A3P overcurrent after start-up operation	Check inverter circuit compressor nr. 1 (see page 75).
	11	12	13	Forced stop	BRC...	PCB A6P overcurrent after start-up operation	Check inverter circuit compressor nr. 2 (see page 75).
L9	1	5	6	Forced stop	BRC...	PCB A3P overcurrent during start-up operation	Check inverter circuit compressor nr. 1 (see page 75).
	10	11	12	Forced stop	BRC...	PCB A6P overcurrent during start-up operation	Check inverter circuit compressor nr. 2 (see page 75).
LC	14	15	16	Forced stop	BRC...	Transmission error between A1P - A3P	Check connection main PCB A1P - inverter PCB compressor nr. 1 A3P.
	19	20	21	Forced stop	BRC...	Transmission error between A1P - A7P	Check connection main PCB A1P - inverter PCB fan nr. 1 A7P.
	24	25	26	Forced stop	BRC...	Transmission error between A1P - A4P	Check connection main PCB A1P - inverter PCB fan nr. 2 A4P.
	30	31	32	Forced stop	BRC...	Transmission error between A1P - A6P	Check connection main PCB A1P - inverter PCB compressor nr. 2 A6P.
	33	34	35	Forced stop	BRC...	Transmission error between A1P - A5P (5~12 hp), A8P (14~20 hp)	Check connection main PCB A1P - auxiliary PCB A5P.
P1	01	02	03	Warning	Auto recovery	Unbalance power supply > 4% PCB A3P	Check power supply unbalance maximum 2%.
	07	08	09	Warning	Auto recovery	Unbalance power supply > 4% PCB A6P	Check power supply unbalance maximum 2%.
P2	00			Forced stop	PCB A1P - BS3	Refrigerant auto-charge interrupted	Restart refrigerant auto-charge function.
P4	01	04	05	Warning	Auto recovery	A3P fin thermistor faulty	Replace inverter board A3P (see page 75).
	06	07	08	Warning	Auto recovery	A6P fin thermistor faulty	Replace inverter board A6P (see page 75).
P8				Warning	PCB A3P - BS3	Freeze-up indoor during refrigerant auto-charge	Restart refrigerant auto-charge function. Check air flow rate indoor units.
P9				Warning	PCB A3P - BS1	Refrigerant auto-charge finished normal	Perform test run.
PA				Warning	Continue auto-charge	Refrigerant auto-charge detects no (more) liquid available in cylinder	Connect new refrigerant cylinder to continue refrigerant auto-charge.
PE				Warning	Continue auto-charge	Refrigerant auto-charge in last stage	Continue refrigerant charge.
PF				Warning	PCB A3P - BS1	Long test run failed [2-88-0] without input additional charge [2-14]	Change field setting [2-14] > 0, or change field setting [2-88-1] and start new test run (hold BS2 > 5 seconds).

Main	Sub error code			Status outdoor	Reset	Cause	Solution
Error	Main	Sub1	Sub2				
PJ	4	5	6	Forced stop	Power reset	Incorrect type of inverter PCB compr. 1	Adjust horsepower setting main board, or change inverter pcb correct type.
	9	15	16	Forced stop	Power reset	Incorrect type of inverter PCB compr. 1	Adjust horsepower setting main board, or change inverter pcb correct type.
	10	17	18	Forced stop	Power reset	Incorrect type of inverter PCB compr. 2	Adjust horsepower setting main board, or change inverter pcb correct type.
	12	13	14	Forced stop	Power reset	Incorrect type of inverter PCB compr. 2	Adjust horsepower setting main board, or change inverter pcb correct type.
U0				Warning	Auto recovery	Refrigerant shortage detection - warning	Recover and recharge correct refrigerant charge, replace not correctly operating expansion valve(s).
	5			Warning	Auto recovery	Refrigerant shortage detection - abnormality	Recover and recharge correct refrigerant charge, replace not correctly operating expansion valve(s).
	6			Warning	Auto recovery	Refrigerant shortage detection - heating	Recover and recharge correct refrigerant charge, replace not correctly operating expansion valve(s).
	08	09	10	Warning	Auto recovery	Refrigerant shortage detection - HP sensor	Recover and recharge correct refrigerant charge, replace S1NPH (see page 85).
U1	1	5	7	Forced stop	Power reset outdoor	Reverse phase detection L1 - L3	Check presence of phase L3 at PCB A1P, correct phase sequence at terminal X1M.
	4	6	8	Forced stop	Power reset outdoor	Reverse phase detection L1 - L3 power-on	Check presence of phase L3 at PCB A1P, correct phase sequence at terminal X1M.
U2	01	08	11	Forced stop	Auto recovery	PCB A3P low voltage	Check voltage to A3P, replace inverter board A3P (see page 75).
	02	09	12	Forced stop	Auto recovery	PCB A3P phase missing	Check phases to A3P, replace inverter board A3P (see page 75).
	03	10	13	Forced stop	Auto recovery	Capacitor(s)- DC circuit inverter nr. 1 not charging.	Check phases to A3P, replace inverter board A3P (see page 75).
	22	25	28	Forced stop	Auto recovery	PCB A3P low voltage	Check phases to A6P, replace inverter board A6P (see page 75).
	23	26	29	Forced stop	Auto recovery	PCB A3P phase missing	Check phases to A6P, replace inverter board A6P (see page 75).
	24	27	30	Forced stop	Auto recovery	Capacitor(s)- DC circuit inverter nr. 2 not charging.	Check phases to A6P, replace inverter board A6P (see page 75).

Main	Sub error code			Status outdoor	Reset	Cause	Solution
	Error	Main	Sub1				
U3	02			Forced stop	Restart test run	Test run interrupted manually	Restart test run outdoor.
	03			Forced stop	Restart test run	Test run not performed yet	Start test run outdoor.
	04			Forced stop	Restart test run	Test run end abnormal	Check indoor unit error code.
	05			Forced stop	Restart test run	Test run abort initial transmission	Check communication - restart test run outdoor.
	06			Forced stop	Restart test run	Test run abort normal transmission	Check communication - restart test run outdoor.
	07			Forced stop	Restart test run	Test run abort transmission abnormal	Check communication - restart test run outdoor.
	08			Forced stop	Restart test run	Test run abort transmission all units	Check communication - restart test run outdoor.
U4	01			Forced stop	Auto recovery	Communication error Q1Q2 between outdoor	Check communication between outdoor units, power supply outdoor.
	03			Forced stop	Auto recovery	Communication error F1F2 to BS unit or indoor unit	Check communication outdoor unit to BS units, BS units to indoor units, power supply BS and indoor.
U7	01			Forced stop	Auto recovery	Error DTA104A61	Refer to option handbook.
	02			Forced stop	Auto recovery	Error initialization DTA104A61	Check dip switch settings DTA104A61 (refer to option handbook).
	03			Forced stop	Auto recovery	Communication error between main and sub 1	Check communication between main outdoor unit and sub 1 outdoor unit.
	04			Forced stop	Auto recovery	Communication error between main and sub 2	Check communication between main outdoor unit and sub 2 outdoor unit.
	05			Forced stop	Auto recovery	Multi-system abnormality	Check combination outdoor units is according to installation manual.
	06			Forced stop	Auto recovery	Multi-address abnormality	Check address each outdoor unit in same multi-outdoor system.
	07			Forced stop	Auto recovery	More than 3 units in multi-combination (Q1Q2)	Change installation to maximum 3 outdoor units same system.
	11			Forced stop	Auto recovery	Test run detects > 64 indoor units same outdoor	Change installation to maximum 64 indoor units and limit connection ratio outdoor / indoor max. 200%.
	24			Caution	Power reset DTA104	Duplication address setting multiple optional boards DTA104A61,62	Change unique address on each optional board DTA104A61,62 in same F1F2 OUT/D bus
U9	01			Forced stop	Auto recovery	Minimum 1 indoor unit detects system error (UA, U4, UH, A0)	Follow troubleshooting error code shown on indoor controllers other than U9.

Main	Sub error code			Status outdoor	Reset	Cause	Solution
Error	Main	Sub1	Sub2	Status outdoor	Reset	Cause	Solution
UA	03			Forced stop		Mix of R22, R407C and R410A indoor units detected	Change installation with only R410A type indoor units.
	16			Forced stop	Auto recovery	More than 64 indoor units detected same system	Change installation to have maximum 64 indoor units to same system.
	17			Forced stop	Auto recovery	Local setting abnormality	Verify and return field settings outdoor to factory value.
	18			Forced stop		Outdoor unit not compatible to indoor units (refrigerant type)	Change installation with only R410A type indoor units connect to this outdoor unit(s).
	19			Forced stop	Auto recovery	Local set alarm	Verify and return field settings outdoor to factory value.
	20			Forced stop	Auto recovery	Outdoor unit not compatible in multi-combination	Change outdoor unit(s) to have correct combination.
	21			Alarm	Auto recovery	BPMK units detected	Change installation without BPMK units.
	22			Alarm	Auto recovery	Single installation abnormality	Change installation only published combination is used.
	23			Alarm	Auto recovery	BS unit too high index indoor connected	Change installation BS unit within published index.
	25			Alarm	Auto recovery	BS main bus zone alarm	Change field wiring between outdoor and BS units to have correct communication.
	26			Alarm	Auto recovery	BS branch bus zone alarm	Change field wiring between BS units to have correct communication.
	27			Alarm	Auto recovery	No BS units detected	System must detected minimum 50% indoor units connected to BS unit(s).
	28			Alarm	Auto recovery	Other than BS-Q-A detected	Only use BS-Q-A to VRV4 heat recovery system.
	29			Alarm	Auto recovery	BS unit too low index indoor connected	Change installation BS unit within published index.
	30			Alarm	Auto recovery	Heat pump/heat recovery connection abnormality	Change outdoor unit(s) to have correct combination.
	31			Alarm	Auto recovery	Only single REMQ5T7 in system	Change system lay out to have or 5-5 or 8+5.
	35			Forced stop	Auto recovery	REMQ5T not in correct combination	Change system lay out to have or 5-5 or 8+5.
	38			Forced stop	Auto recovery	Altherma hydro unit detected	Only hydro units LT model HXY-A7 and HT model HXHD125 connectable.
	39			Forced stop	Auto recovery	Incorrect combination units	Change installation only published combination is used.
	43			Forced stop	Auto recovery	Incorrect combination	Change installation only published combination is used.
50			Forced stop	Auto recovery	HT hydro unit connected to BS unit	Change installation HT hydro unit without BS unit.	
51			Forced stop	Auto recovery	Only hydro units detected	System must detected minimum 50% indoor units connected to BS unit(s).	
53			Forced stop	Power reset	PCB BS unit wrong dip switch setting	Check dip switches BS unit.	

Main	Sub error code			Status outdoor	Reset	Cause	Solution
Error	Main	Sub1	Sub2	Status outdoor	Reset	Cause	Solution
UH	01			Forced stop	Auto recovery	Auto address F1f2 bus inconsistency	Wait till initialization outdoor is end, perform cross wiring check.
UF	01			Forced stop	Auto recovery	Test run outdoor - auto address F1f2 bus inconsistency	Wait till initialization outdoor is end, perform cross wiring check.
	05			Forced stop	Perform test run	Test run detect stop valves closed or incorrect	Open stop valves, verify field piping among outdoor unit(s) and BS unit(s).

3.3. Error codes related to FX..Q-M/N/P/A

Main	Sub error code			Status outdoor	Reset	Cause	Solution
Error	Main	Sub1	Sub2	Status outdoor	Reset	Cause	Solution
A3				Cool thermo off	Auto recovery	Float switch open during thermo on (cooling)	Check float switch status, drain pipe no blockage, drain pipe raiser < 600 mm.
A6	01			Thermo off	BRC1..	Fan motor locked	Rpm counter no signal from motor to indoor main board when output.
	10			Thermo off	BRC1..	Fan motor overcurrent	Check motor power circuit. Replace fan motor / indoor board.
	11			Thermo off	BRC1..	Fan motor locked	Rpm counter no signal at off condition.
AH	03			Warning	BRC1..	Communication error main PCB / self cleaning PCB	Check wire harness connections.
	04			Warning	BRC1..	Dust detection sensor error	Check wire harness connections.
	05			Warning	BRC1..	Dust collection error	Check for clogging by dust between brush-arm and dust collector box.
	06			Warning	BRC1..	Air filter rotation error	Check rotation mechanism air filter.
	07			Warning	BRC1..	Damper rotation error	Check rotation mechanism damper.
	08			Warning	BRC1..	Filter cleaning time error	Filter auto cleaning program could not be performed 24 hr operation.
	09			Warning	BRC1..	Auto self cleaning disabled	Check field settings to enable auto filter cleaning.
AF				Thermo off	BRC1..	Float switch open during thermo off	Check for drain water returning from other indoor, expansion valve correct closing thermo off.
AJ	01			Thermo off	Auto recovery	Capacity adaptor missing	Add corresponding capacity adaptor onto spare part PCB
	02			Thermo off	Power reset	Incorrect expansion valve motor	Use correct expansion valve motor (between gear type and direct drive).
C1	01			Thermo off	Auto recovery	Communication error main PCB / inverter PCB fan motor	Check for communication between main PCB and inverter PCB fan motor.
	02			Thermo off	Auto recovery	Communication error main PCB / auxiliary PCB	Check for communication between main PCB and inverter PCB fan motor.

Main	Sub error code				
Error	Main	Status outdoor	Reset	Cause	Solution
C4	02	Thermo off	Auto recovery	Coil thermistor short circuit	Check coil thermistor resistance (see page 56).
	03	Thermo off	Auto recovery	Coil thermistor open circuit	Check wire harness connections coil thermistor (see page 56).
C5	02	Thermo off	Auto recovery	Gas thermistor short circuit	Check gas thermistor resistance (see page 56).
	03	Thermo off	Auto recovery	Gas thermistor open circuit	Check wire harness connections gas thermistor (see page 56).
C6	01	Thermo off	Auto recovery	Faulty combination main PCB - inverter PCB fan motor	Change inverter PCB fan motor correct type (see page 141).
C9	02	Thermo off	Auto recovery	Air thermistor short circuit	Check air thermistor resistance (see page 56).
	03	Thermo off	Auto recovery	Air thermistor open circuit	Check wire harness connections air thermistor (see page 56).
CJ	02	Thermo off	Auto recovery	Air thermistor BRC... short circuit	Check air thermistor BRC... resistance (see page 56).
	03	Thermo off	Auto recovery	Gas thermistor open circuit	Check wire soldering air thermistor BRC... (see page 56).
CE	01	Thermo off	Auto recovery	No signal from optional presence sensor	Check wire harness connections
	02	Thermo off	Auto recovery	No signal from optional floor temperature sensor	Check wire harness connections
	03	Thermo off	Auto recovery	Faulty signal from optional floor temperature sensor	Check pins connector no short circuit
	04	Thermo off	Auto recovery	High temperature detection or electric noise floor temperature sensor	Check resistance floor temperature sensor
U4	01	Thermo off	Auto recovery	Communication error indoor - BS unit	Check communication between BS unit and indoor unit(s)
U9		Thermo off	Auto recovery	Communication error other indoor unit - BS unit	Check other indoor units with error other than U9
UA	13	Thermo off	Power reset	Indoor unit refrigerant type not compatible to outdoor unit	Change system lay out - remove this indoor unit from system
	15	Thermo off	Power reset	Outdoor unit is not compatible to self cleaning panel (up to VRVII)	Mount standard decoration panel

4. Symptom based troubleshooting

Not available yet

5. Component checklist

Overview of component checklists:

Power supply54	Compressor motor M1C, M2C 71
Thermistors R1T - R15T56	Inverter boards A3P, A4P, A6P, A7P 75
Solenoid valves Y11S, Y12S, Y2S and 4-way valves Y3S~Y5S61	Pressure sensor S1NPH, S1NPL 85
Motorized expansion valve coil Y1E~Y6E64	Pressure switches S1PH, S2PH 89
Fan motor(s) M1F, M2F67	Crankcase heater E1HC, E2HC 91



INFORMATION

Each component check procedure contains a link to a wiring diagram. If several VRV4 models are listed for a wiring diagram, the link navigates to the wiring diagram of the VRV4 with the lowest capacity.

5.1. Required tools for component check

Figure 2 - Required tools for component check



5.2. Power supply

Technical specification		Description
<p>The power supply towards the inverter driven compressor(s) and fan motor(s) contains 3 sections:</p> <ol style="list-style-type: none"> 1. Incoming power supply 3 phase 400 VAC + neutral + ground. 2. AC-DC converter delivering a stabilized DC voltage of approximately 560 VDC (1,41 x mains voltage). 3. DC-AC 3 phase Pulse Width Modulated frequency inverter. 		<p>The power supply to the control board is used:</p> <ol style="list-style-type: none"> 1. To verify rotation direction for 3 phase motors (indicated by RPP (Reverse Phase Protection)). 2. To supply 230 VAC to coil of solenoid valves and 4-way valves. 3. To generate low voltage DC power supply for main control board and inverter boards.
Location		
Wiring diagram	Switch box	Unit
REM5T7Y1B, REYQ8T7Y1B, REYQ10T7Y1B, REYQ12T7Y1B		
REYQ14T7Y1B, REYQ16T7Y1B, REYQ18T7Y1B, REYQ20T7Y1B		
Check procedure		
Mechanical check		

1. Confirm that the Daikin VRV indoor units are switched off via the user control system.
2. Remove the switch box cover, refer to ["Removing the switch box cover" on page 103](#) (REM5T7Y1B, REYQ8~12T7Y1B) or ["Removing the switch box cover" on page 111](#) (REYQ14~20T7Y1B).
3. Confirm that the power supply cable is firmly fixed to the switch box below the power supply terminals and earth connection.
4. Check that the fuses on the main board, auxiliary board and noise filter(s) do not show any damage.
5. Check that the varistors (on main board F1S, F2S) and auxiliary board (F1S) are not cracked.

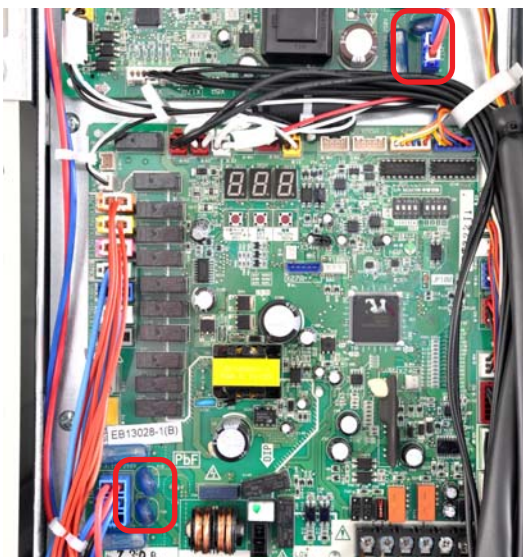

REMQ5T7Y1B, REYQ8T7Y1B,
REYQ10T7Y1B, REYQ12T7Y1B

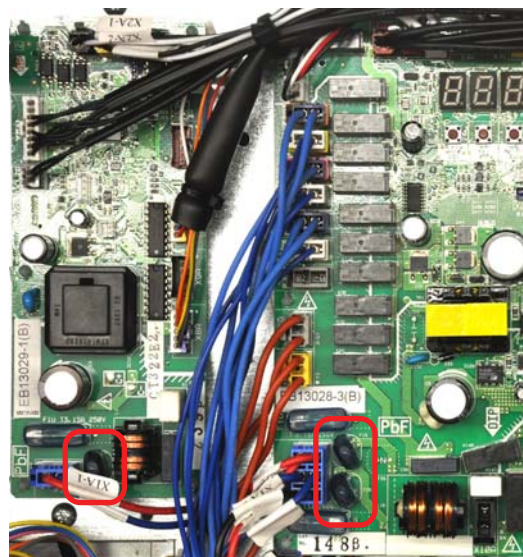

REYQ14T7Y1B, REYQ16T7Y1B,
REYQ18T7Y1B, REYQ20T7Y1B

Electrical check

Check the power supply cable from the main power distribution board to the outdoor unit:

1. Without power supply: minimum insulation: use a Megger of minimum 500 VDC to confirm insulation between each power supply terminal and ground is minimum 1 Mega Ohm. If insulation is less there is an earth leakage problem.



WARNING: RISK OF ELECTROCUTION.

2. After above test is confirmed, switch on circuit breaker. Confirm voltage at the power supply terminals is correct:
 - Between phases L1 – L2 – L3:
400 VAC ± 10%.
Unbalance between phases: maximum 2%.
 - Between phase L1 and N: 230 VAC ± 10%.
3. Power supply on the control circuit main board and auxiliary board:
 - Confirm voltage power is present at connector X1A (A5P for 5~12 hp, A8P for 14~20 hp).
 - Confirm the green Led HAP “service monitor” blinks.
 - Confirm 16 VDC at connector X37A on main control board A1P.

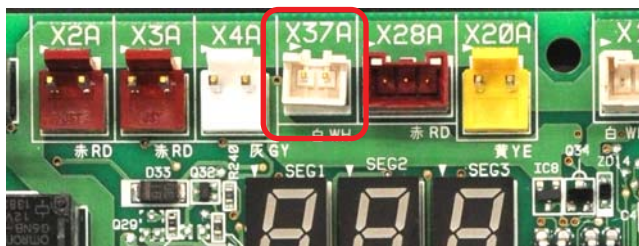

5.3. Thermistors R1T - R15T

Technical specification		Description
<p>2 different types of thermistors are used; the resistance vs. temperature characteristic for each type is shown in Table 2-1 on page 58.</p>		<p>The thermistors are used to measure the temperature at multiple locations inside the Daikin VRV4 heat recovery unit. The measured temperatures are processed by the main board (A1P) and auxiliary board (5~12 hp: A5P, 14~20 hp: A8P).</p>
Location		
Wiring diagram	Switch box	Unit
REM5T7Y1B, REYQ8T7Y1B		
REYQ10T7Y1B, REYQ12T7Y1B		
REYQ14T7Y1B, REYQ16T7Y1B		

REYQ18T7Y1B, REYQ20T7Y1B

Check procedure

Mechanical check

1. Switch off the Daikin VRV indoor units via the user control system.
2. Locate the thermistor and check if thermal contact with the piping or ambient is ensured.

Electrical check

Table 2-1 on page 58 must be used to compare the measured resistance with the correct resistance for the measured temperature with a contact thermometer.

1. Switch off the Daikin VRV indoor units via the user control system (indoor control or central control device). Wait till outdoor unit stops: when no more thermostat demand exists, outdoor may perform pump down operation.
2. Remove the front plate assembly, refer to "Removing the front plate assembly" on page 102.

	<p>WARNING: RISK OF ELECTROCUTION.</p>
--	-----------------------------------------------

3. Remove the switch box cover, refer to "Removing the switch box cover" on page 103 (REMQU5T7Y1B, REYQ8~12T7Y1B) or "Removing the switch box cover" on page 111 (REYQ14~20T7Y1B).
4. From Table 2-1 on page 58, select the connector terminals of the thermistor that must be checked.
5. Measure the temperature of the pipe using a contact thermometer at the location where the sensor is mounted. For checking R1T, measure outdoor air.
6. Unplug the connector from the appropriate PCB and measure the resistance between the pins listed in Table 2-1 on page 58.
 - Compare the measured resistance with the range determined by the temperature in Table 2-2 on page 59 and Table 2-3 on page 60.
7. If the measured resistance does not match the listed value, the thermistor must be replaced, refer to "Replacing a thermistor" on page 145

E.g. thermistor R3T "Liquid pipe receiver inlet" (main board connector X30A-pin1+2):

- Measured temperature on the pipe with contact thermometer: 23.1°C.
- Unplug the sensor and measure the resistance on connector X30A between pin 1 and 2: 21.3 kOhm.

- As defined in [Table 2-1](#), this is a type 1 thermistor; the resistance values are defined by [Table 2-2 on page 59](#):
 - Resistance at 20°C: 25.0060 kOhm.
 - Resistance at 25°C: 20.0000 kOhm.
- The measured value 21.3 kOhm is inside the range, thermistor R3T (A1P) passes the check.

**INFORMATION**

The outdoor main board “digital gauge display” allows to monitor a number of thermistors.

If the measured resistance of the thermistor matches the temperature measured with the contact thermometer but the temperature for the corresponding thermistor is not correct on the display of the outdoor main control board, replace main board A1P (see [page 125](#)) or auxiliary board (A5P for 5 ~ 12 hp, A8P for 14 ~ 20 hp (see [page 128](#))).

Table 2-1: Thermistors identification, location, connection and type overview

Wiring symbol	Function	Processed on board				Connector pin	Type	Digital gauge: Mode 1 - code
		Outdoor size (hp)						
		5+8	10+12	14+16	18+20			
R1T	Outdoor air temperature	A1P	A1P	A1P	A1P	Main-X18A-pin1+3	1	50
R21T	Discharge pipe compressor 1	A1P	A1P	A1P	A1P	Main-X19A-pin1+2	2	47
R22T	Discharge pipe compressor 2			A1P	A1P	Main-X19A-pin3+4	2	48
R3T	Liquid pipe receiver inlet	A1P	A1P	A1P	A1P	Main-X30A-pin1+2	1	
R4T	Liquid pipe upper heat exchanger	A1P	A1P	A1P	A1P	Main-X30A-pin3+4	1	
R5T	Liquid pipe middle heat exchanger	A1P	A1P	A1P	A1P	Main-X30A-pin5+6	1	
R6T	Gas outlet sub-cool heat exchanger	A1P	A1P	A1P	A1P	Main-X30A-pin7+8	1	52
R7T	Liquid pipe at stop valve	A1P	A1P	A1P	A1P	Main-X30A-pin9+10	1	
R8T	Gas pipe upper heat exchanger	A1P	A1P	A1P	A1P	Main-X29A-pin1+2	1	53
R9T	Gas pipe middle heat exchanger	A1P	A1P	A1P	A1P	Main-X29A-pin3+4	1	54
R10T	Suction pipe from indoor (cooling)	A1P	A1P	A1P	A1P	Main-X29A-pin5+6	1	
R11T	Coil temperature middle heat exchanger	A5P	A5P	A8P	A8P	Aux-X15A-pin1+2	1	55
R12T	Suction pipe to compressor(s)	A5P	A5P	A8P	A8P	Aux-X15A-pin3+4	1	51
R13T	Gas pipe heat exchanger inverter cooler	A5P	A5P	A8P	A8P	Aux-X17A	1	
R14T	Liquid pipe bypass receiver	A5P	A5P	A8P	A8P	Aux-X15A-pin5+6	1	
R15T	Compressor body		A1P		A1P	Main-X19A-pin5+6	2	49

Table 2-2: Thermistor resistance / temperature characteristics

Sensor type 1	
T°C	kΩ
-30	361.772
-25	265.470
-20	196.920
-15	147.569
-10	111.658
-5	85.261
0	65.671
5	50.995
10	39.915
15	31.480
20	25.006
25	20.000
30	16.101
35	13.043
40	10.628
45	8.710
50	7.176
55	5.941
60	4.944
65	4.135
70	3.476
75	2.935
80	2.489
85	2.121
90	1.814
95	1.558
100	1.343
105	1.161

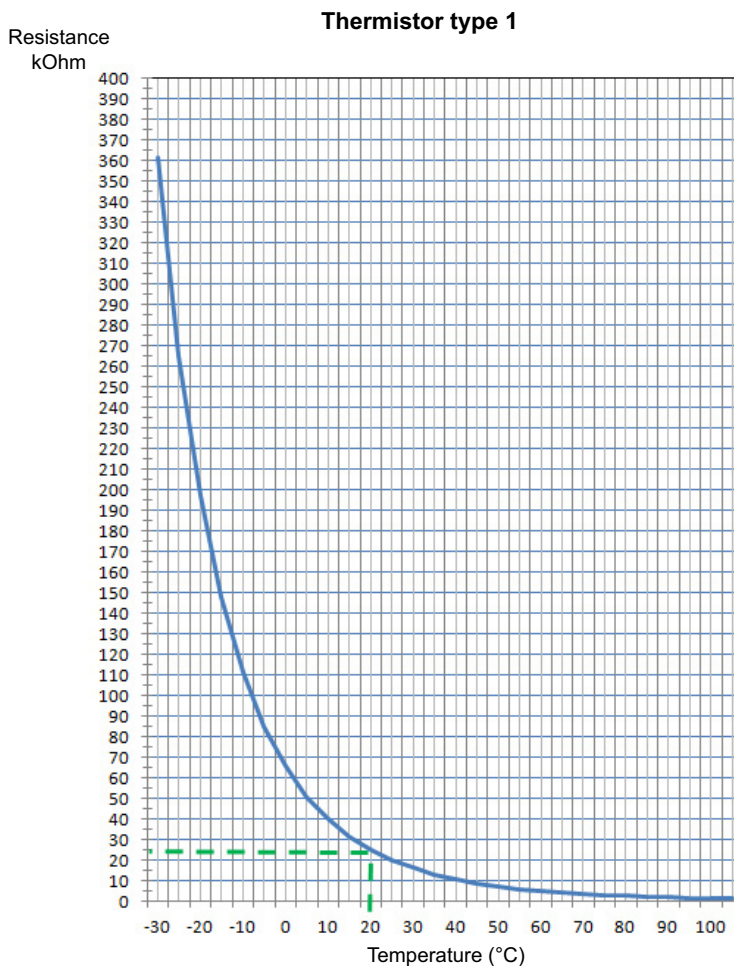

Reference point thermistor



Table 2-3: Thermistor resistance / temperature characteristics

Sensor type 2	
T°C	kΩ
-30	3257.371
-25	2429.222
-20	1827.883
-15	1387.099
-10	1061.098
-5	817.933
0	635.083
5	496.571
10	391.007
15	309.951
20	247.270
25	198.467
30	160.224
35	130.070
40	106.152
45	87.073
50	71.770
55	59.474
60	49.518
65	41.417
70	34.792
75	29.350
80	24.859
85	21.136
90	18.038
95	15.449
100	13.277
105	11.440
110	9.890
115	8.579
120	7.465
125	6.516
130	5.704
135	5.007
140	4.408
145	3.891
150	3.443

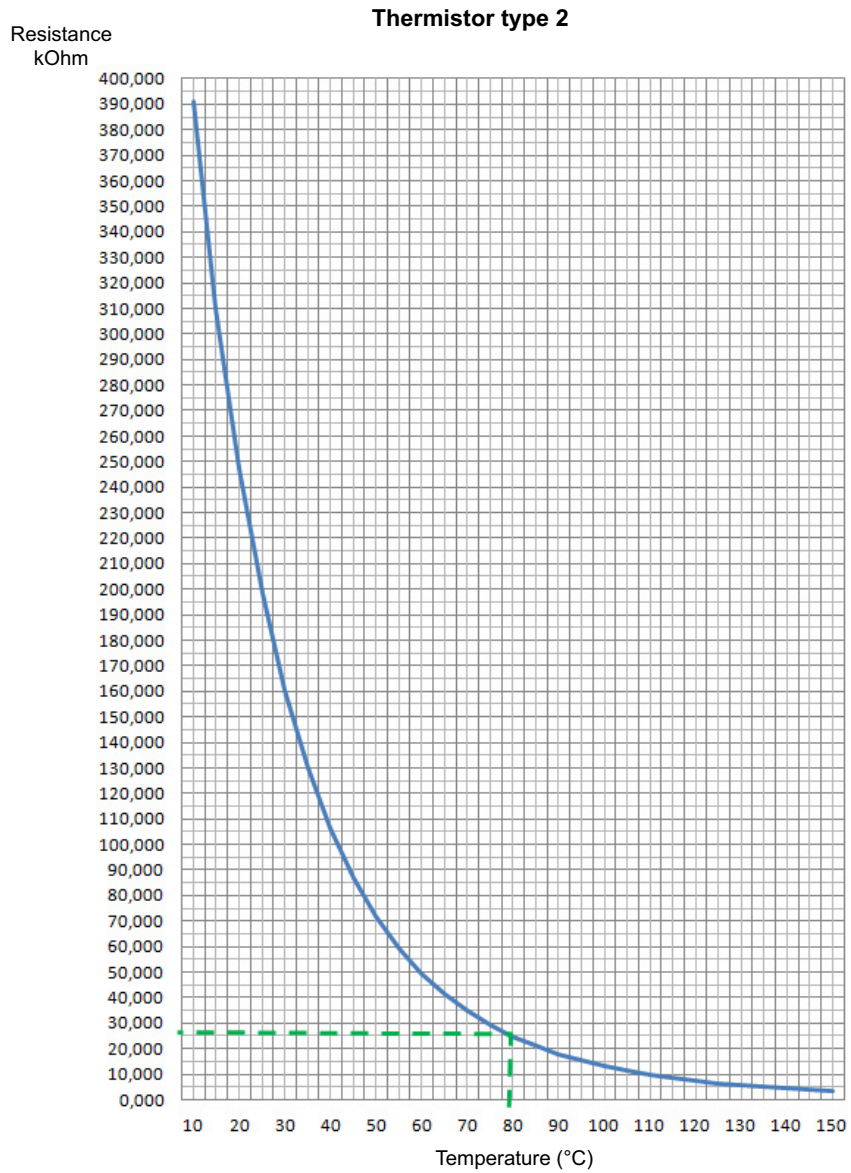

Reference point thermistor



5.4. Solenoid valves Y11S, Y12S, Y2S and 4-way valves Y3S~Y5S

Technical specification		Description
Different types coils are used on: <ul style="list-style-type: none"> The 4-way valves (3 pieces per unit). Solenoid valves (maximum 3 pieces per unit). 		1. The 4-way valves are used to set the connected circuit: <ul style="list-style-type: none"> To discharge pressure (if coil is receiving 0 Volt), or To suction pressure if coil is receiving 220~240 VAC. 2. The solenoid valves are used to: <ul style="list-style-type: none"> Return oil from oil separator to suction pipe of compressor if operating and DSH is minimum 15 K. Enable flow of liquid to the liquid receiver.
Location		
Wiring diagram	Switch box	Unit
REMQ5T7Y1B, REYQ8T7Y1B, REYQ10T7Y1B, REYQ12T7Y1B		
REYQ14T7Y1B, REYQ16T7Y1B, REYQ18T7Y1B, REYQ20T7Y1B		
Check procedure		
Mechanical check		

- Switch off the Daikin VRV indoor units via the user control system.
- Locate the coil of the 4-way valve or solenoid valve and verify the screw is firmly fixing the coil to the valve body. Check damage (burst).

Electrical check

Table 2-4 below must be used to compare the measured resistance with the correct resistance for the coil of the 4-way valve or solenoid valve.

1. Switch off the Daikin VRV indoor units via the user control system (indoor control or central control device). Wait till outdoor unit stops: when no more thermostat demand exists, outdoor may perform pump down operation.
2. Remove the front plate assembly, refer to "Removing the front plate assembly" on page 102.



WARNING: RISK OF ELECTROCUTION.

3. Remove the switch box cover, refer to "Removing the switch box cover" on page 103 (REMQ5T7Y1B, REYQ8~12T7Y1B) or "Removing the switch box cover" on page 111 (REYQ14~20T7Y1B).
4. Remove the lower front cover, refer to "Removing the switch box cover" on page 103.
5. From the Table 2-4, select the connector of the coil that must be checked.
6. Unplug the connector from the appropriate PCB and measure the resistance of the coil using a multi-meter.
 - Compare the measured resistance with the value in Table 2-4.
7. If the measured resistance does not match the listed value, the coil must be replaced, refer to "Replacing a 4 way valve coil (Y3S, Y4S, Y5S)" on page 150.

E.g. coil solenoid valve Y2S "solenoid valve inlet liquid receiver" (main board connector X15A):

- Unplug the sensor and measure the resistance on connector X15A: 1.35 kOhm.
- As defined in Table 2-4:
 - Resistance: 1.34 kOhm.
 - Tolerance $\pm 10\%$.
- The measured value 1.35 kOhm is inside the range, the coil Y2S passes the check.

Table 2-4: Valves connector, and resistance overview

Wiring symbol	Function	Processed on board	Connector pin	Resistance (kOhm) (tolerance 3%)			
				Outdoor size (hp)			
				5+8	10+12	14+16	18+20
Y11S	Solenoid valve oil return compressor 1	A1P	X7A	2.12			
Y12S	Solenoid valve oil return compressor 2	A1P	X8A	-		2.12	
Y2S	Solenoid valve inlet liquid receiver	A1P	X15A				1.34
Y3S	4-way valve indoor dual pressure	A1P	X13A	1.50		1.36	
Y4S	4-way valve lower heat exchanger	A1P	X16A	1.50			1.36
Y5S	4-way valve upper heat exchanger	A1P	X17A	1.50			

Outlook main control board

- Y5S
- Y4S
- Y3S
- Y11S
- Y12S
- Y2S

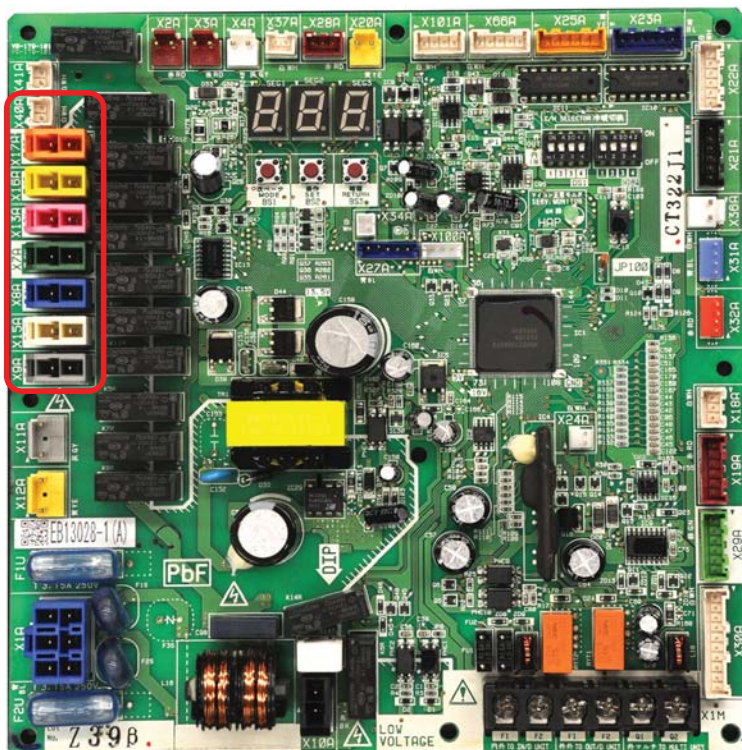

5.5. Motorized expansion valve coil Y1E~Y6E

Technical specification		Description
2 different types of coils are used on the expansion valves (6 pieces per unit): <ul style="list-style-type: none"> • The large size receiving maximum 3000 pulses: 4 sets. • The small size receiving maximum 480 pulses: 2 sets. • On the main board the plugs are the 6 pin type. • On the sub board the plugs are the 5 pin type. 		The motorized expansion valves are used: <ul style="list-style-type: none"> • To control the flow. Depending on location, trigger point is superheat or sub-cool. • To stop flow completely when closing (equivalent 0 pulses).
Location		
Wiring diagram	Switch box	Unit
REM5T7Y1B, REYQ8T7Y1B, REYQ10T7Y1B, REYQ12T7Y1B		
REYQ14T7Y1B, REYQ16T7Y1B, REYQ18T7Y1B, REYQ20T7Y1B		
Check procedure		
Mechanical check		
<ol style="list-style-type: none"> 1. Switch off the Daikin VRV indoor units via the user control system. 2. Locate the coil of the expansion valve motors and verify coil is firmly slid onto the body of the expansion valve. 		
Electrical check		

Table 2-6 on page 66 must be used to compare the measured resistance with the correct resistance for the coil of the motorized expansion valve.

1. Switch off the Daikin VRV indoor units via the user control system (indoor control or central control device). Wait till outdoor unit stops: when no more thermostat demand exists, outdoor may perform pump down operation.

2. Remove the front plate assembly, refer to "Removing the front plate assembly" on page 102.

	<p>WARNING: RISK OF ELECTROCUTION.</p>
-----------------------------------------------------------------------------------	-----------------------------------------------

3. Remove the switch box cover, refer to "Removing the switch box cover" on page 103 (REMQ5T7Y1B, REYQ8~12T7Y1B) or "Removing the switch box cover" on page 111 (REYQ14~20T7Y1B).
4. Remove the lower front cover, refer to "Removing the switch box cover" on page 103.
5. From Table 2-5 below, select the connector of the coil that must be checked.
6. Unplug the connector from the appropriate PCB and measure the resistance of the 4 coils using a multi-meter.
 - Compare the measured resistance with the range in Table 2-6 on page 66.
7. If the measured resistance does not match the listed value, the coil must be replaced, refer to "Replacing an expansion valve coil (Y1E, Y3E, Y4E, Y6E)" on page 160.

E.g. coil expansion valve Y1E "coil expansion valve upper heat exchanger" (main board connector X21A):

- Unplug the sensor and measure the resistance on connector X21A: between red wire and each other wire (white, yellow, orange and blue): 148 Ω.
- As defined in Table 2-6 on page 66:
 - Resistance: 150 Ω.
 - Tolerance ± 15 Ω.
- The measured value 148 Ω is inside the range, the coil Y1E passes the check.

Table 2-5: Expansion valve coil identification, location, connection and type

Symbol	Function	Board	Connector	Colour	Plug size	N° of wires	Type	Connector layout	
								5~12	14~20
Y1E	Expansion valve motor upper heat exchanger	Main	X21A	Black	Large (6pin)	5	3000	type 1	type 1
Y2E	Expansion valve motor liquid sub-cool heat exchangers	Main	X22A	White	Large (6pin)	5	480	type 1	type 2
Y3E	Expansion valve motor middle heat exchanger	Main	X23A	Blue	Large (6pin)	5	3000	type 1	type 1
Y4E	Expansion valve motor purge receiver	Main	X25A	Orange	Large (6pin)	5	3000	type 1	type 1
Y5E	Expansion valve motor radiant cooler inverter boards	Sub	X8A	Blue	Small (5pin)	5	480	type 3	type 3
Y6E	Expansion valve motor bypass receiver	Sub	X10A	Orange	Small (5pin)	5	3000	type 4	type 4

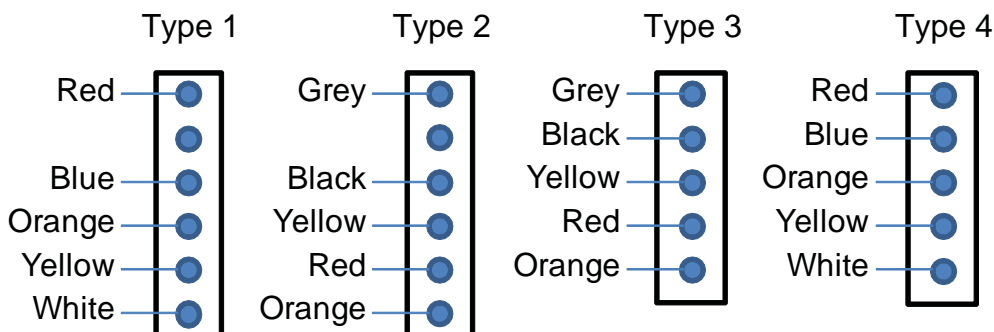

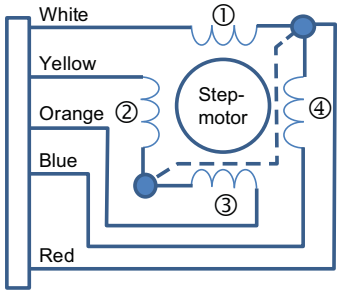

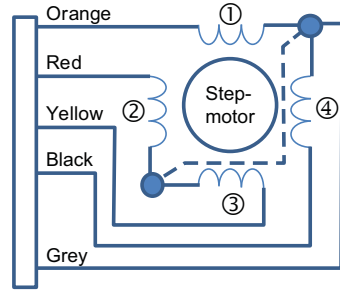



Table 2-6: Expansion valve coil connector, and resistance overview

Type coil: max. pulses	Wiring symbol	PCB - ref. connector	Internal wiring coil step motor expansion valve	Resistance tolerance	
3000 	Y1E Y3E Y4E Y6E	Main - X21A Main - X23A Main - X25A Sub - X10A		150 Ω (± 15 Ω)	Y1E: upper 
480 	Y2E Y5E	Main - X22A Sub - X8A		46 Ω (± 3 Ω)	Y2E: sub-cool 

5.6. Fan motor(s) M1F, M2F

Technical specification		Description
<p>2 different types of fan motors are used: for 5 to 12 hp there is 1 fan motor, for 14 till 20 hp there are 2 fan motors. The motor has 2 connectors: the frequency power signal through 3 wires (U, V, W) and the rotation counter feed back by 5 wires.</p>		<p>The fan motors can run on different speeds to supply the required air flow rate. The required air flow rate is set to reach target condensing and evaporation temperatures.</p>
Location		
Wiring diagram	Switch box	Unit
REMQ5T7Y1B, REYQ8T7Y1B, REYQ10T7Y1B, REYQ12T7Y1B		
REYQ14T7Y1B, REYQ16T7Y1B, REYQ18T7Y1B, REYQ20T7Y1B		

Check procedure

Mechanical check

1. Switch off the Daikin VRV indoor units via the user control system.
2. Remove the front plate assembly, refer to "Removing the front plate assembly" on page 102.



WARNING: RISK OF ELECTROCUTION.

3. Remove the switch box cover, refer to "Removing the switch box cover" on page 103 (REMQ5T7Y1B, REYQ8~12T7Y1B) or "Removing the switch box cover" on page 111 (REYQ14~20T7Y1B).
4. Locate the connectors of the fan motors (left side in switchbox) and verify all connectors are firmly fixed.

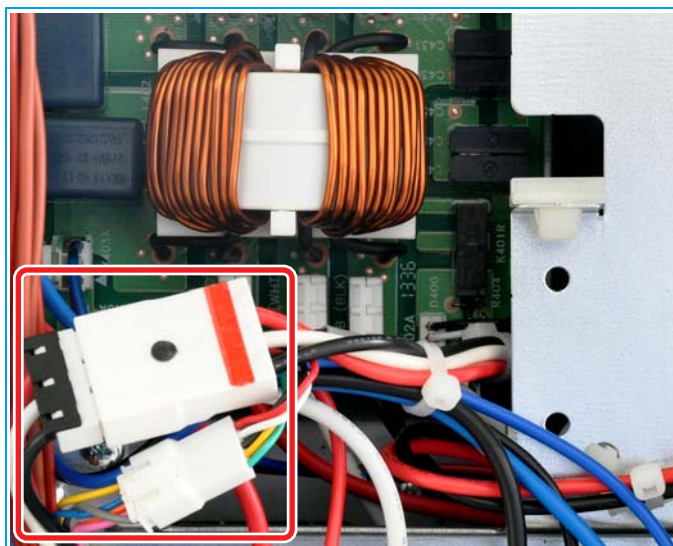

REMQ5T7Y1B, REYQ8T7Y1B,
REYQ10T7Y1B, REYQ12T7Y1B

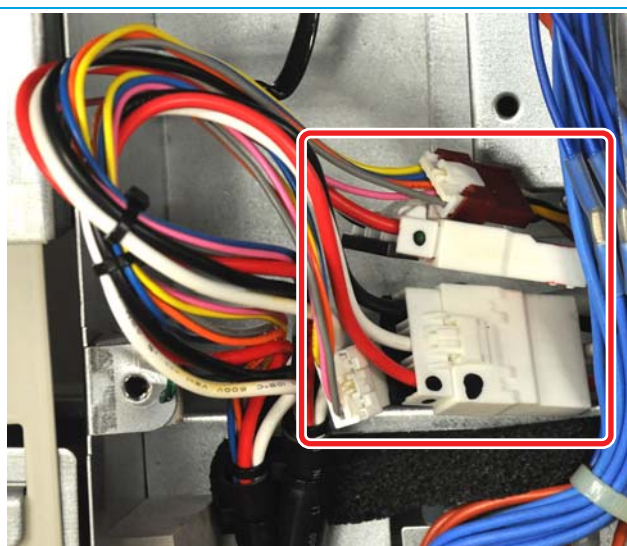

REYQ14T7Y1B, REYQ16T7Y1B,
REYQ18T7Y1B, REYQ20T7Y1B

5. Once the outdoor unit has stopped, move propeller(s) by hand to confirm no lock or high friction occurs.

Electrical check

Table 2-7 on page 70 must be used:

- Two electrical tests must be executed:
 - Electrical test with the fan motor connectors unplugged:
 - Measurement of the motor windings resistance,
 - Diode check of the rpm counter circuit inside the fan motor.
 - Electrical test with the fan motor connectors plugged:
 - Measurement to check that the rpm counter for each motor winding gives 4 pulses per rotation.

Check connectors unplugged

1. Switch off the Daikin VRV indoor units via the user control system (indoor control or central control device). Wait until the outdoor unit stops: when no more thermostat demand exists, outdoor may perform pump down operation.
2. Remove the front plate assembly, refer to "Removing the front plate assembly" on page 102.

- Remove the lower front plate, refer to ["Removing the switch box cover" on page 103](#).



WARNING: RISK OF ELECTROCUTION.

- Remove the switch box cover, refer to ["Removing the switch box cover" on page 103](#) (REMQ5T7Y1B, REYQ8~12T7Y1B) or ["Removing the switch box cover" on page 111](#) (REYQ14~20T7Y1B).
- Measure the rectifier voltage and wait until the voltage drops below 10 V before proceeding, refer to ["Checking the rectifier voltage" on page 117](#).
- From [Table 2-7 on page 70](#) or [Table 2-8 on page 70](#), select the connector(s) of the fan motor(s) that must be checked.
- Unplug the connectors from the appropriate fan motor(s), refer to [Table 2-10 on page 70](#).
- Use a multimeter to measure the resistance of the motor windings and diode check on the rpm counter plug.
- Compare the measured resistance/diode check with the range in [Table 2-7 on page 70](#) or [Table 2-8 on page 70](#) and [Table 2-9 on page 70](#).
- If the measured resistance / diode check does not match the listed value, the fan motor must be replaced, refer to ["Replacing a fan propeller" on page 167](#).

Check connectors reconnected



WARNING

This check requires to move the propellor by hand.

To prevent the automatic start of the fan, a plug will be removed to force error E3-01, disabling power to the fans.

- Power the outdoor unit.
- Unplug X2A from board A1P.

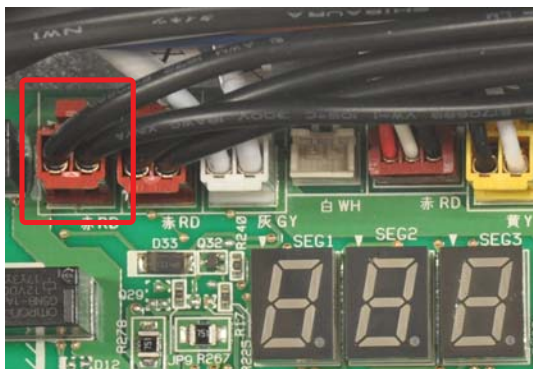

- Check that the error E3-01 is displayed.
- While slowly turning the propeller, verify the feed back signal of the rpm counter. Refer to [Figure 3 on page 70](#).
- If the measured feedback signal does not match the signal in [Figure 3 on page 70](#), the fan motor must be replaced. Refer to ["Replacing a fan propeller" on page 167](#).

Example fan motor M1F

- Unplug the fan motor and measure the 3 motor windings on connector X1A: 9.6 Ω , 9.4 Ω and 9.5 Ω .
- As defined in [Table 2-7 on page 70](#):
 - Resistance: 9,5 Ω .
 - Tolerance \pm 5%.
- The measured values 9.6 Ω , 9.4 Ω and 9.5 Ω are inside the range, the fan motor passes the check.

Checking method connectors unplugged.

Table 2-7: REMQ5T7Y1B, REYQ8~12T7Y1B motor winding resistance (Ω)

X1A	Red	White	Black
Red	-	9.5	9.5
White	9.5	-	9.5
Black	9.5	9.5	-

Table 2-8: REYQ14~20T7Y1B motor winding resistance (Ω)

X1A/X3A	Red	White	Black
Red	-	6.5	6.5
White	6.5	-	6.5
Black	6.5	6.5	-

Table 2-9: REMQ5T7Y1B, REYQ8~20T7Y1B diode check rpm counter

		Com (black test lead)				
		Grey	Pink	Orange	Blue	Yellow
VDC (red test lead)	X2A/X4A					
	Grey	-	0.56	1.60	1.60	1.60
	Pink	1.17	-	2.36	2.36	2.36
	Orange	OL	OL	-	OL	OL
	Blue	OL	OL	OL	-	OL
Yellow	OL	OL	OL	OL	-	

OL= Open Loop ($\infty\Omega$)

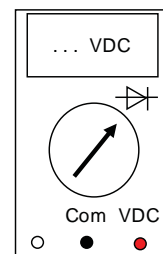

Figure 3 - rpm counter feedback signal

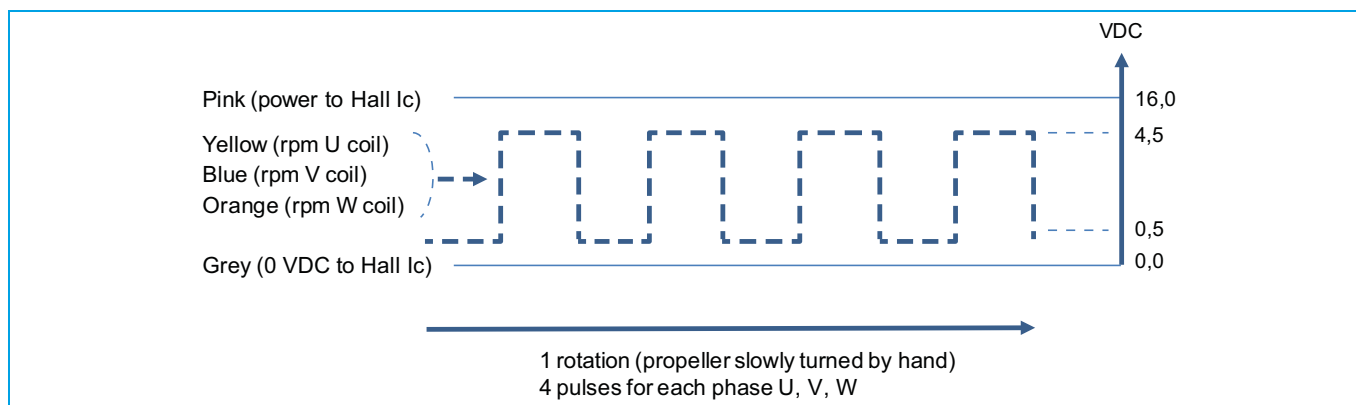
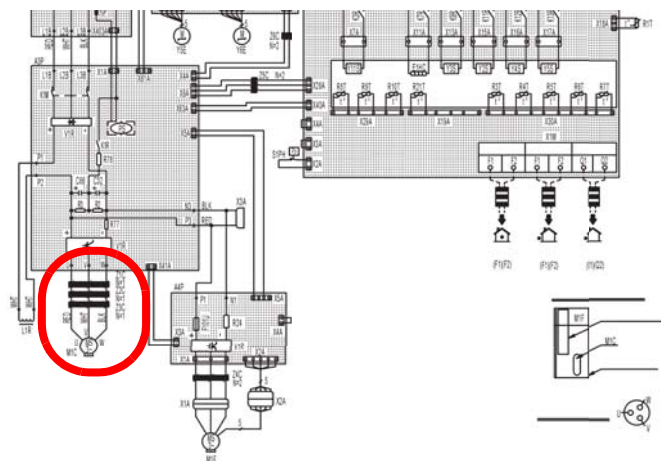
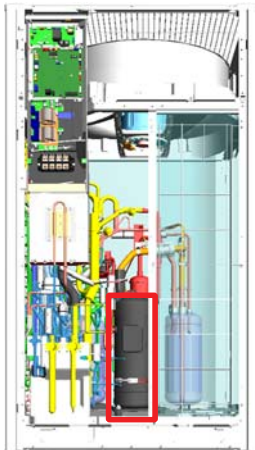
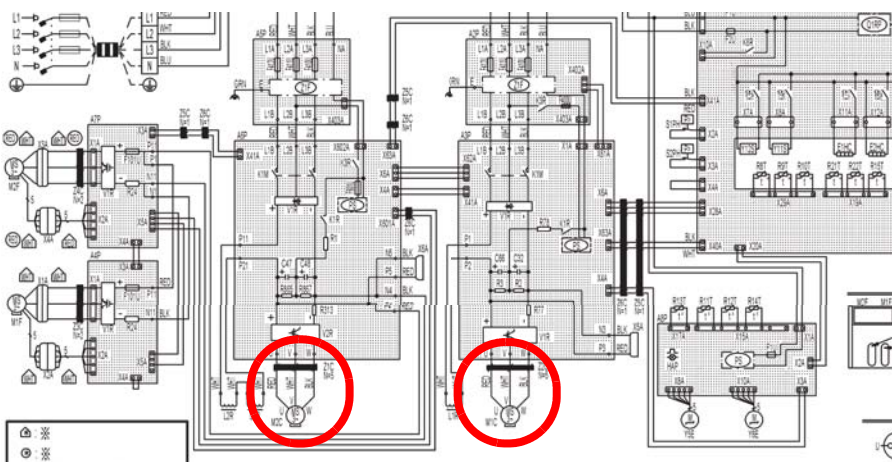
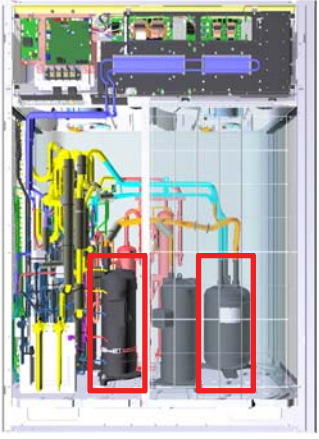

Table 2-10: REMQ5T7Y1B, REYQ8~20T7Y1B Fan motor location, connector and speed

Wiring symbol	Part name	Location		Connector wiring symbol power / rpm counter		Maximum rotation speed	
		5~12 hp	14~20 hp	5~12 hp	14~20 hp	5~12 hp	14~20 hp
M1F	Fan motor 1	Centre	Right	X1A / X2A	X1A / X2A	890	1180
M2F	Fan motor 2	-	Left	-	X3A / X4A	-	1360

5.7. Compressor motor M1C, M2C

Technical specification		Description
Compressor name: JT1GCVDKYR (M1C), JT15JVDKYR (M2C) Type: Hermetically sealed scroll compressor		The compressor(s) M1C (M2C) compress(es) the refrigerant in the refrigerant circuit.
Location		
Piping diagram		Unit
REMQ5T7Y1B, REYQ8T7Y1B, REYQ10T7Y1B, REYQ12T7Y1B		
		
REYQ14T7Y1B, REYQ16T7Y1B, REYQ18T7Y1B, REYQ20T7Y1B		
		
Check procedure		
Electrical check		

- Two electrical tests must be executed:
 - Electrical test with the compressor connectors unplugged:
 - Check of the compressor motor windings.
 - Electrical test with the compressor connectors plugged:
 - Measurement of the 3-phase current and frequency.

Check connectors unplugged

1. Switch off the Daikin VRV indoor units via the user control system (indoor control or central control device). Wait until the outdoor unit stops: when no more thermostat demand exists, outdoor may perform pump down operation.

2. Remove the front plate, refer to ["Removing the front plate assembly" on page 102](#).



WARNING: RISK OF ELECTROCUTION.

3. Remove the switch box cover, refer to ["Removing the switch box cover" on page 103](#) (REMQ5T7Y1B, REYQ8~12T7Y1B) or ["Removing the switch box cover" on page 111](#) (REYQ14~20T7Y1B).
4. Measure the rectifier voltage and wait until the voltage drops below 10 V before proceeding, refer to ["Checking the rectifier voltage" on page 117](#).
5. Pull the compressor insulation velcro strip to access the compressor junction box.
6. Remove the cover from the compressor junction box.
7. Remove the wiring from the compressor.

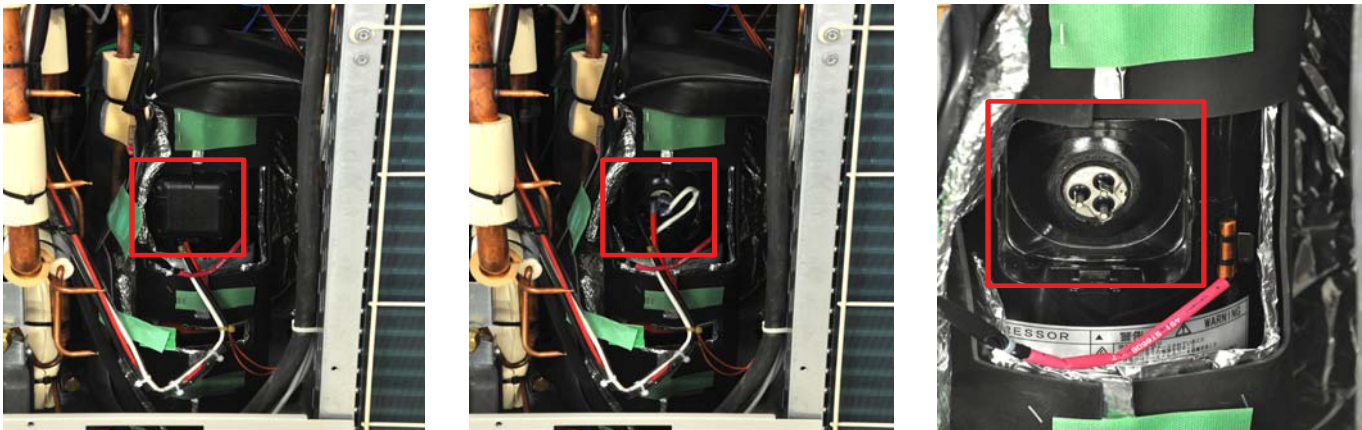

8. Measure the compressor motor windings U-V, V-W and U-W; define the compressor type in [Table 2-13 on page 73](#), all measurements must be in accordance with the values in [Table 2-11 on page 73](#) or [Table 2-12 on page 73](#).
9. Megger the compressor using 500 or 1000 V DC, the insulation must be higher than 1 MOhm.
10. Replace the compressor if the compressor motor windings and/or insulation measurements fail. Refer to ["Replacing a compressor" on page 169](#).

Table 2-11: Compressor motor M1C winding resistance (Ω) - type 1 (4 pole)

JT1GCVDKYR	U	V	W
U	-	0,90	0,90
V	0,90	-	0,90
W	0,90	0,90	-

Table 2-12: Compressor motor M2C winding resistance (Ω) - type 2 (6 pole)

JT15JVDKYR	U	V	W
U	-	0,47	0,47
V	0,47	-	0,47
W	0,47	0,47	-

Table 2-13: Indication type compressor used each size outdoor unit

Wiring symbol	REM-Q-T7	REY-Q-T7						
	5	8	10	12	14	16	18	20
M1C	1	1	2	2	1	1	1	1
M2C	-	-	-	-	1	1	2	2

Type 1= model name JT1GCVDKYR, type 2= model name JT15JVDKYR

Check connectors unplugged

1. Reconnect the compressor wires to the compressor, observe the colour code.

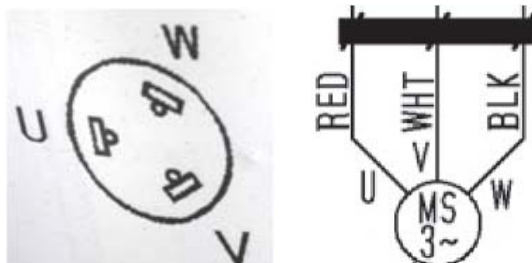

2. Clamp the current probe around a single compressor wire.

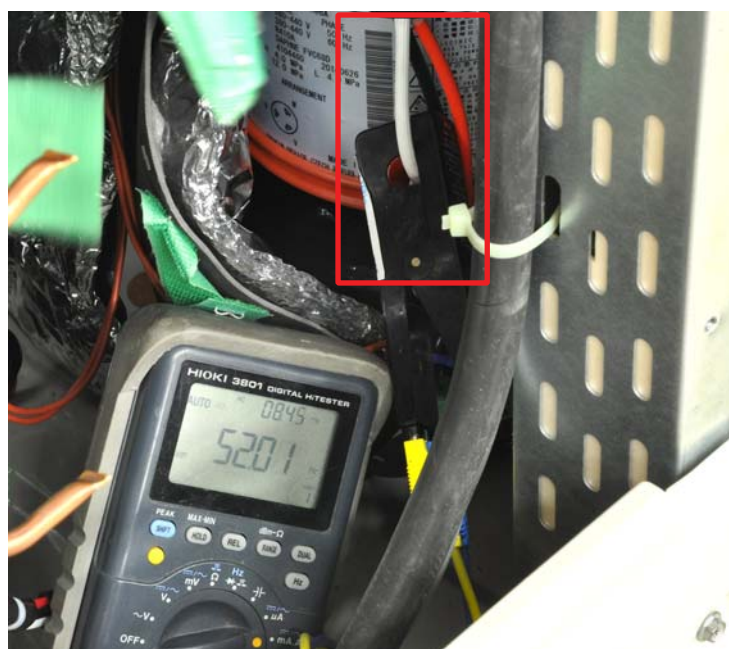

3. Switch on the Daikin VRV indoor units via the user control system (indoor control or central control device).
4. Check if the values comply with the reference values in [Table 2-14](#).

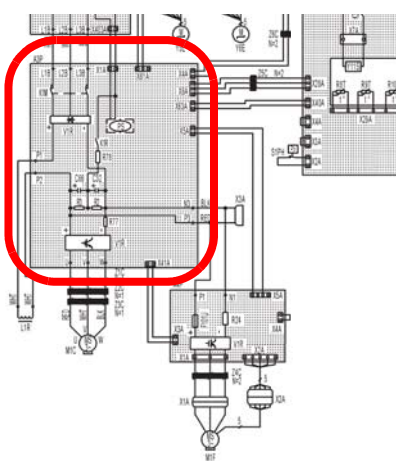
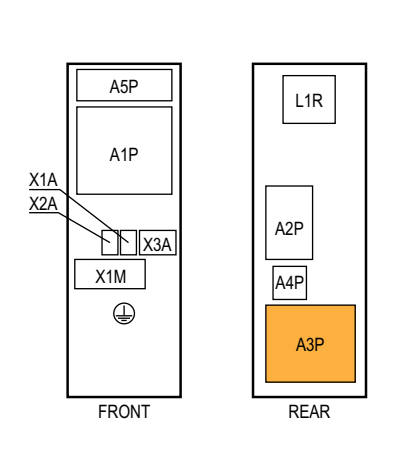

Table 2-14: Compressor current and start-up frequency reference values

	Compressor type 1	Compressor type 2
I (A)	6 - 12	6 - 12
F (Hz)	52	60

5. Repeat steps 2 to 4 for the 2 other compressor wires.
6. Replace the compressor if the frequency or current measurements fail. Refer to ["Replacing a compressor"](#) on page 169.

5.8. Inverter boards A3P, A4P, A6P, A7P

5.8.1. Inverter board for compressor JT1GCVDKYR (type 1)

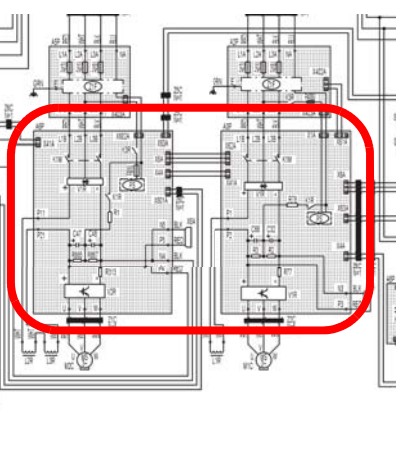
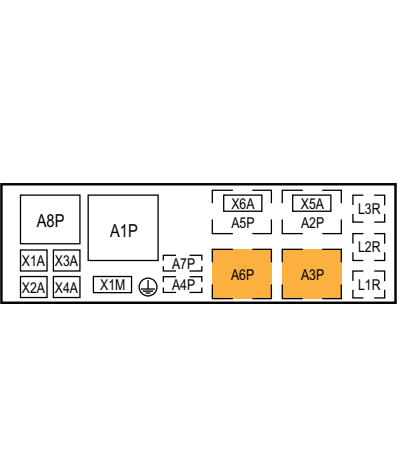
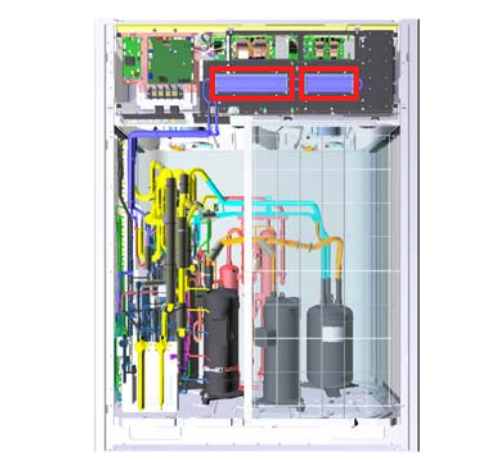
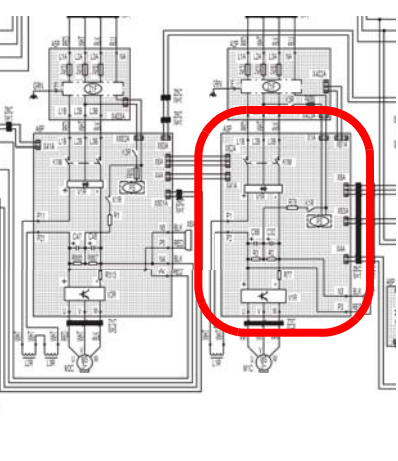
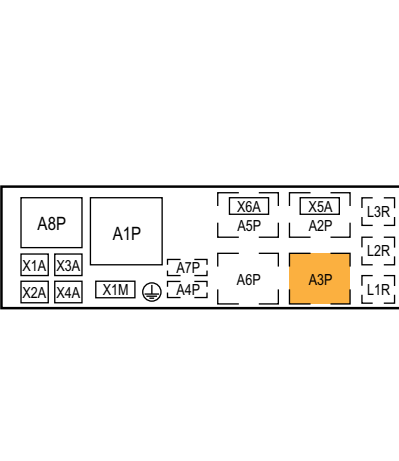
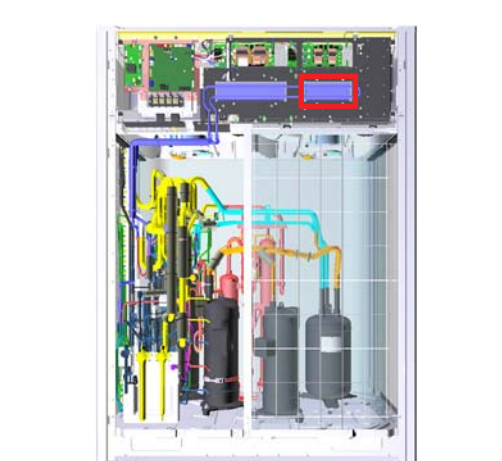
Technical specification		Description
The inverter is a 400 V 3-phase inverter.		The inverter drives the compressor (type 1).
Location		
Wiring diagram	Switch box	Unit
REMQ5T7Y1B, REYQ8T7Y1B		
		
REYQ14T7Y1B, REYQ16T7Y1B		
		
REYQ18T7Y1B, REYQ20T7Y1B		
		

Check procedure

Electrical check

- Two electrical tests must be executed:
 - Electrical test with the compressor connectors unplugged:
 - Check of the diodes in the diode module and the transistors in the power module.
 - Electrical test with the compressor connectors plugged:
 - Measurement of the 3-phase output voltages.
 - Measurement of the compressor current and frequency.

Check connectors unplugged

1. Switch off the Daikin VRV indoor units via the user control system (indoor control or central control device). Wait until the outdoor unit stops: when no more thermostat demand exists, outdoor may perform pump down operation.
2. Remove the front plate assembly, refer to ["Removing the front plate assembly" on page 102](#).



WARNING: RISK OF ELECTROCUTION.

3. Remove the switch box cover, refer to ["Removing the switch box cover" on page 103](#) (REMQ5T7Y1B, REYQ8~12T7Y1B) or ["Removing the switch box cover" on page 111](#) (REYQ14~20T7Y1B).
4. Measure the rectifier voltage and wait until the voltage drops below 10 V before proceeding, refer to ["Checking the rectifier voltage" on page 117](#).
5. Pull the velcro strip of the compressor insulation and pull the insulation away from the junction box.
6. Remove the cover from the compressor junction box.
7. Remove the wiring from the compressor.

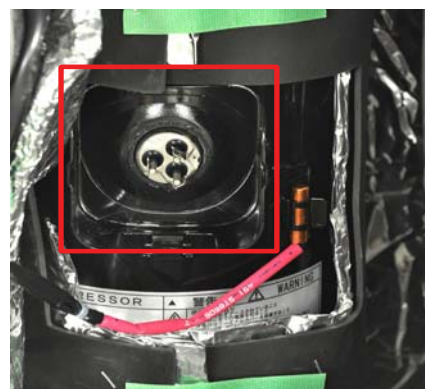
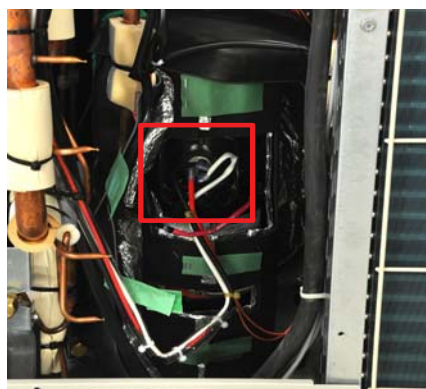
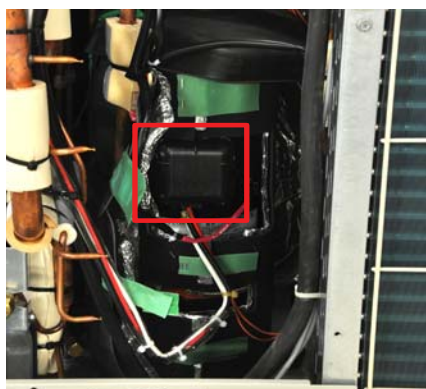

CAUTION

If the outdoor unit is equipped with 2 compressors (14~20 hp), the wires of both compressors must be unplugged.

8. Repeat steps 5 to 7 for the second compressor (REYQ14~20T7 only).
9. Using a multimeter in diode measurement, check the compressor inverter board as described in [Table 2-15](#) and [Table 2-16 on page 78](#).
10. Replace the inverter board if the measurements fail. Refer to ["Replacing the compressor inverter board A3P \(type 1 \(G\) compressor\) \(REYQ14~20T7Y1B\)" on page 135](#) or ["Replacing the compressor inverter board A6P \(type 2 \(J\) compressor\) \(REYQ14~20T7Y1B\)" on page 138](#).

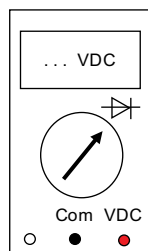
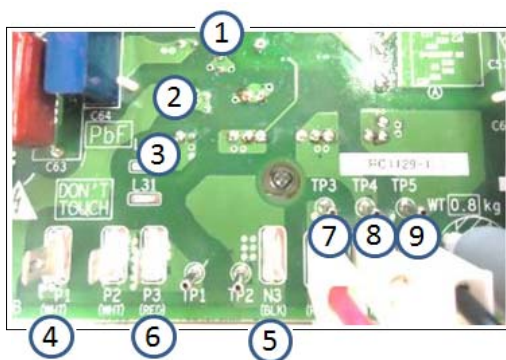

Table 2-15: Transistor check of compressor inverter module type 1 - part 1

VDC	Com	Ref	VDC	Com	Ref	VDC	Com	Ref
4	1	O.L.	5	1	0,5	5	4	0,9
4	2	O.L.	5	2	0,5	-	-	-
4	3	O.L.	5	3	0,5	-	-	-
1	4	0,5	1	5	O.L.	4	5	O.L.
2	4	0,5	2	5	O.L.	-	-	-
3	4	0,5	3	5	O.L.	-	-	-

Table 2-16: Transistor check of compressor inverter module type 1 - part 2

VDC	Com	Ref	VDC	Com	Ref	VDC	Com	Ref
6	7	O.L.	5	7	0,4	5	6	0,9
6	8	O.L.	5	8	0,4			
6	9	O.L.	5	9	0,4			
7	6	0,4	7	N3	O.L.	6	5	O.L.
8	6	0,4	8	N3	O.L.			
9	6	0,4	9	N3	O.L.			

Check connectors reconnected to the compressor

1. Connect the compressor wires to the inverter analyzer (tool part N° 1368521).

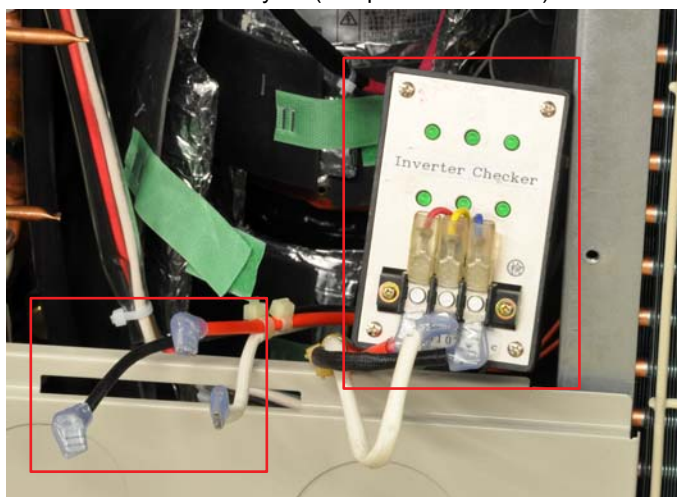

WARNING: RISK OF ELECTROCUTION.

Do not touch the inverter analyser terminals
Do not touch the compressor wire plugs.





CAUTION

Make sure that the unplugged compressor wires do not touch any part (risk of short circuit).

2. Restore power to the outdoor unit.
3. Start Power transistor (28) (= set to 1) (can be done during initialisation of the outdoor unit).
4. Check that all 6 LEDs on the inverter analyzer tool blink. Replace the inverter board if the measurements fail. Refer to ["Replacing the compressor inverter board A3P \(type 1 \(G\) compressor\) \(REYQ14~20T7Y1B\)"](#) on page 135 or ["Replacing the compressor inverter board A6P \(type 2 \(J\) compressor\) \(REYQ14~20T7Y1B\)"](#) on page 138.
5. Disable Start Power transistor (28) (= set to 0).
6. Check that 2 LEDs on the inverter analyzer tool light, gradually dim and eventually turn off.
7. Switch off the Daikin VRV outdoor units by means of an external circuit breaker.
8. Measure the rectifier voltage and wait until the voltage drops below 10 V before proceeding, refer to ["Checking the rectifier voltage"](#) on page 117.
9. Reconnect the compressor wires to the compressor, observe the colour code.

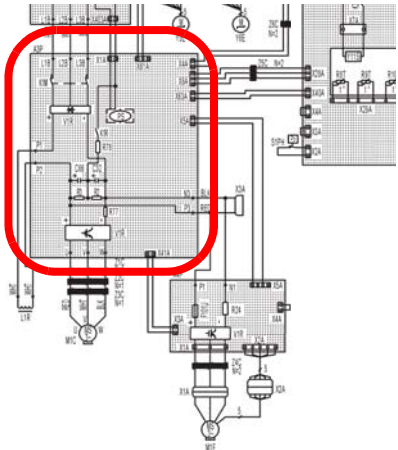
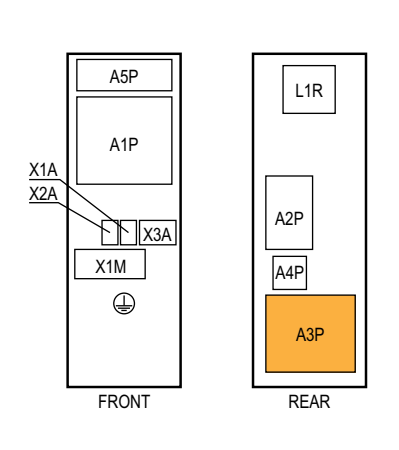
5.8.2. Inverter board for compressor JT15J-VDKYR (type 2)

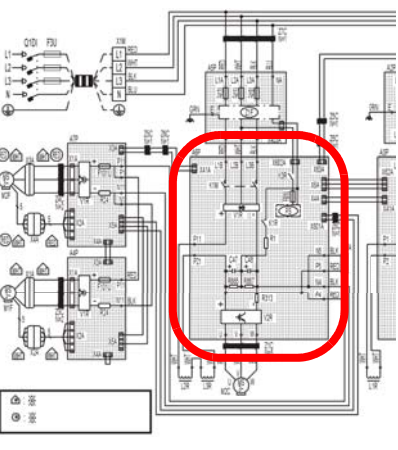
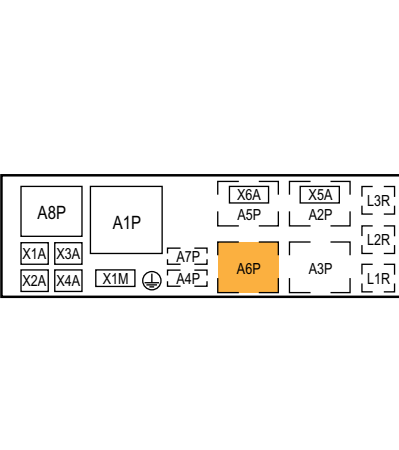
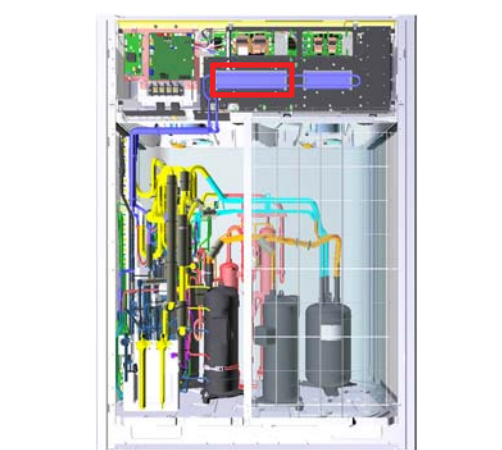
Technical specification		Description
The inverter is a 400 V 3-phase inverter.		The inverter drives the compressor.
Location		
Wiring diagram	Switch box	Unit
REYQ10T7Y1B, REYQ12T7Y1B		
		
REYQ18T7Y1B, REYQ20T7Y1B		
		
Check procedure		
Electrical check		

- Two electrical tests must be executed:
 - Electrical test with the compressor connectors unplugged:
 - Check of the diodes in the diode module and the transistors in the power module.
 - Electrical test with the compressor connectors plugged:
 - Measurement of the 3-phase output voltages.
 - Measurement of the compressor current and frequency.

Check connectors unplugged

1. Switch off the Daikin VRV indoor units via the user control system (indoor control or central control device). Wait until the outdoor unit stops: when no more thermostat demand exists, outdoor may perform pump down operation.
2. Remove the front plate assembly, refer to "Removing the front plate assembly" on page 102.

Action



WARNING: RISK OF ELECTROCUTION.

3. Remove the switch box cover, refer to ["Removing the switch box cover" on page 103](#) (REMQ5T7Y1B, REYQ8~12T7Y1B) or ["Removing the switch box cover" on page 111](#) (REYQ14~20T7Y1B).
4. Measure the rectifier voltage and wait until the voltage drops below 10 V before proceeding, refer to ["Checking the rectifier voltage" on page 117](#).
5. Pull the velcro strip of the compressor insulation and pull the insulation away from the junction box.
6. Remove the cover from the compressor junction box.
7. Unplug the wires from the compressor.

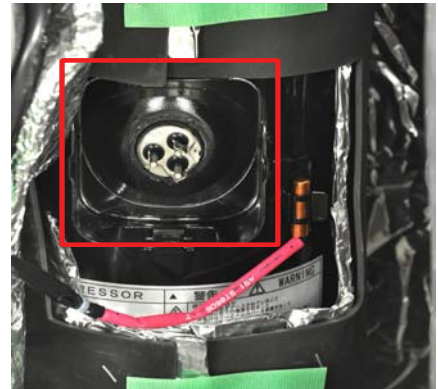
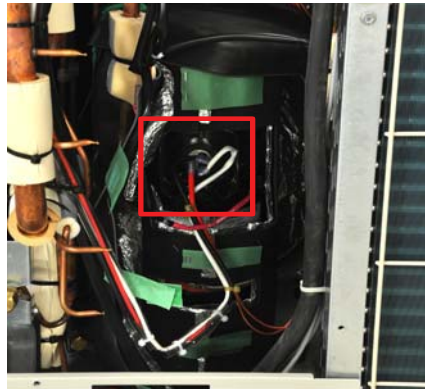
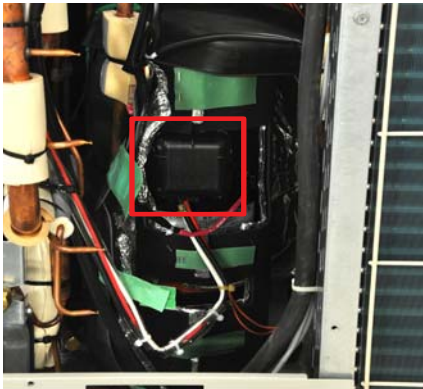

CAUTION

It the outdoor unit is equipped with 2 compressors (14~20 hp), the wires of both compressors must be unplugged.

8. Repeat steps 5 to 7 for the second compressor (REYQ14~20T7 only).
9. Using a multimeter in diode measurement, check the compressor inverter board as described in [Table 2-17 on page 81](#) and [Table 2-18 on page 81](#).
10. Replace the compressor inverter board if the measurements fail. Refer to ["Replacing the compressor inverter board A3P \(type 1 \(G\) compressor\) \(REYQ14~20T7Y1B\)" on page 135](#) or ["Replacing the compressor inverter board A6P \(type 2 \(J\) compressor\) \(REYQ14~20T7Y1B\)" on page 138](#).

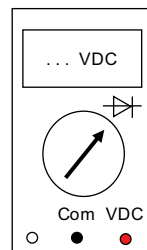
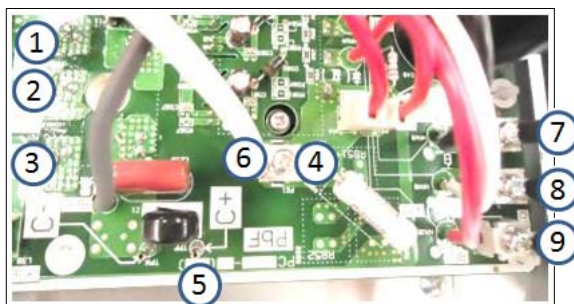

Table 2-17: Transistor check of compressor inverter module type 2 - part 1

VDC	Com	Ref	VDC	Com	Ref	VDC	Com	Ref
4	1	O.L.	5	1	0,5	5	4	0,9
4	2	O.L.	5	2	0,5			
4	3	O.L.	5	3	0,5			
1	4	0,5	1	5	O.L.	4	5	O.L.
2	4	0,5	2	5	O.L.			
3	4	0,5	3	5	O.L.			

Table 2-18: Transistor check of compressor inverter module type 2 - part 2

VDC	Com	Ref	VDC	Com	Ref	VDC	Com	Ref
6	7	O.L.	5	7	0,4	5	6	0,9
6	8	O.L.	5	8	0,4			
6	9	O.L.	5	9	0,4			
7	6	0,4	7	N3	O.L.	6	5	O.L.
8	6	0,4	8	N3	O.L.			
9	6	0,4	9	N3	O.L.			

Check connectors reconnected to the compressor

1. Connect the compressor wires to the inverter analyzer (tool part N° 1368521).

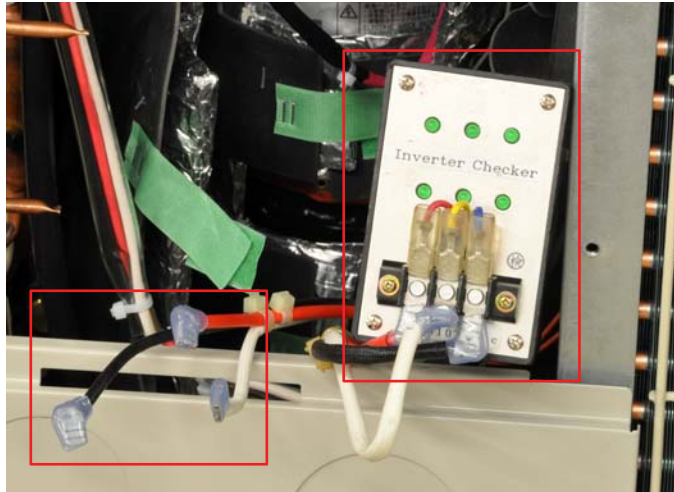
**WARNING: RISK OF ELECTROCUTION.**

*Do not touch the inverter analyser terminals
Do not touch the compressor wire plugs.*

**CAUTION**

Make sure that the unplugged compressor wires do not touch any part (risk of short circuit).

2. Restore power to the outdoor unit.
3. Start Power transistor (28) (= set to 1) (can be done during initialisation of outdoor unit)
4. Check that all 6 LEDs on the inverter analyzer tool blink. Replace the inverter board if the measurements fail. Refer to ["Replacing the compressor inverter board A3P \(type 1 \(G\) compressor\) \(REYQ14~20T7Y1B\)"](#) on page 135 or ["Replacing the compressor inverter board A6P \(type 2 \(J\) compressor\) \(REYQ14~20T7Y1B\)"](#) on page 138.
5. Disable Start Power transistor (28) (= set to 0).
6. Check that 2 LEDs on the inverter analyzer tool light, gradually dim and eventually turn off.
7. Switch off the Daikin VRV outdoor units by means of an external circuit breaker.
8. Measure the voltage on connector X3A (REYQ10~12T7) or X5A/X6A (REYQ18~20T7), wait until the voltage drops below 10 V before proceeding.
9. Reconnect the compressor wires to the compressor, observe the colour code.

5.8.3. Inverter board for fan motor

Technical specification	Description
The inverter is a 400 V 3-phase inverter.	The inverter drives the fan motor.

Location

Wiring diagram	Switch box	Unit
----------------	------------	------

REMQ5T7Y1B, REYQ8T7Y1B, REYQ10T7Y1B, REYQ12T7Y1B

--	--	--

REYQ14T7Y1B, REYQ16T7Y1B, REYQ18T7Y1B, REYQ20T7Y1B

--	--	--

Check procedure

Electrical check

1. Switch off the Daikin VRV outdoor units by means of an external circuit breaker.
2. Remove the front plate assembly, refer to "Removing the front plate assembly" on page 102.

	<p>WARNING: RISK OF ELECTROCUTION.</p>
--	-----------------------------------------------

3. Remove the switch box cover, refer to "Removing the switch box cover" on page 103 (REMQ5T7Y1B, REYQ8~12T7Y1B) or "Removing the switch box cover" on page 111 (REYQ14~20T7Y1B).
4. Measure the voltage on connector X3A (REYQ10~12T7) or X5A/X6A (REYQ18~20T7), wait until the voltage drops below 10 V before proceeding.
5. Unplug the connectors from the appropriate fan motor(s), refer to Table 2-19 on page 84.

Table 2-19: REMQ5T7Y1B, REYQ8~20T7Y1B Fan motor connector

Wiring symbol	Part name	Connector wiring symbol power / rpm counter	
		5~12 hp	14~20 hp
M1F	Fan motor 1	X1A / X2A	X1A / X2A
M2F	Fan motor 2	-	X3A / X4A

Table 2-20: Transistor check of fan inverter module

VDC	Com	Ref	VDC	Com	Ref	VDC	Com	Ref
1	3	O.L.	2	3	0,4	2	1	0,8
1	4	O.L.	2	4	0,4	-	-	-
1	5	O.L.	2	5	0,4	-	-	-
3	1	0,4	3	2	O.L.	1	2	O.L.
4	1	0,4	4	2	O.L.	-	-	-
5	1	0,4	5	2	O.L.	-	-	-

- Using a multimeter in diode measurement, check the fan motor inverter board as described in Table 2-20 on page 84.
- Replace the fan inverter board if the measurements fail. Refer to "Replacing a fan inverter board A4P (REMQ5T7Y1B, REYQ8~12T7Y1B)" on page 141.

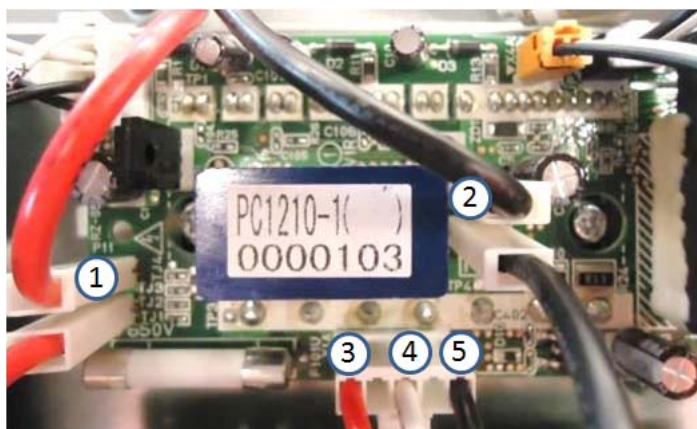

Fan motor nr. 2

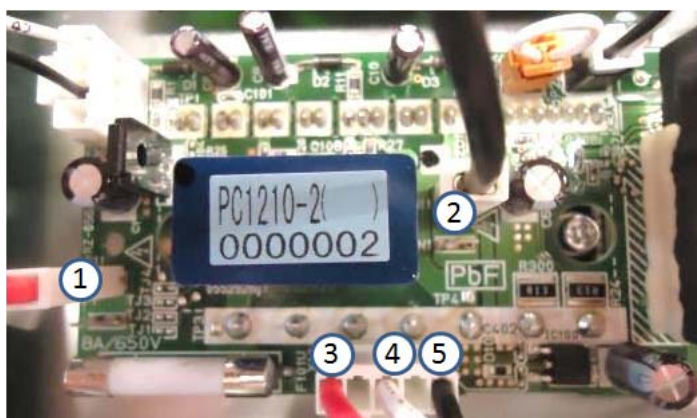

Fan motor nr. 1

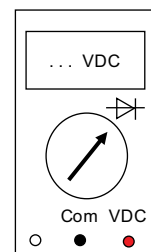

5.9. Pressure sensor S1NPH, S1NPL

Technical specification		Description	
<p>The high pressure (discharge) sensor S1NPH is an analog pressure sensor.</p> <p>The low pressure (suction) sensor S1NPL is an analog pressure sensor.</p>		<p>The high pressure sensor S1NPH detects discharge pressure:</p> <ol style="list-style-type: none"> Cooling: outdoor fan control. Heating= compressor capacity control Protection high discharge pressure. Conversion to saturated condensing temperature to calculate: <ul style="list-style-type: none"> Discharge superheat. Sub-cool. Check minimum and maximum compression ratio. <p>The low pressure sensor S1NPL detects suction pressure:</p> <ol style="list-style-type: none"> Cooling: compressor capacity control. Conversion to saturated evaporation temperature to calculate: <ul style="list-style-type: none"> Suction superheat: heating control EV outdoor evaporator. Suction superheat liquid sub-cool heat exchanger. Suction superheat compressor. Protection low suction pressure. Check minimum and maximum compression ratio. 	
Location			
Wiring diagram		Switch box	Unit
REMQ5T7Y1B, REYQ8T7Y1B, REYQ10T7Y1B, REYQ12T7Y1B			
REYQ14T7Y1B, REYQ16T7Y1B, REYQ18T7Y1B, REYQ20T7Y1B			

Check procedure

Electrical check

Preliminary actions

1. Switch off the VRV indoor units via the remote controller (or any central control device if equipped).
2. Remove the front plate assembly, refer to "Removing the front plate assembly" on page 102.

	WARNING: RISK OF ELECTROCUTION.
-----------------------------------------------------------------------------------	----------------------------------------

3. Remove the switch box cover, refer to "Removing the switch box cover" on page 103 (REMQ5T7Y1B, REYQ8~12T7Y1B) or "Removing the switch box cover" on page 111 (REYQ14~20T7Y1B).
4. Remove the lower front plate assembly, refer to "Removing the switch box cover" on page 103

Low pressure sensor S1NPL

1. Connect a manometer to the service port outdoor suction (centre port).
2. Confirm that the outdoor suction stop valve is open.
3. Set the VRV4 in cooling mode and read the pressure.
4. From the graph in Figure 4 on page 88, determine the expected sensor output signal.
5. Measure the voltage on connector X31A, pin 3 (GND) and pin 1, compare the measured voltage with the expected voltage. A maximum deviation of 0.1 Vdc is allowed.

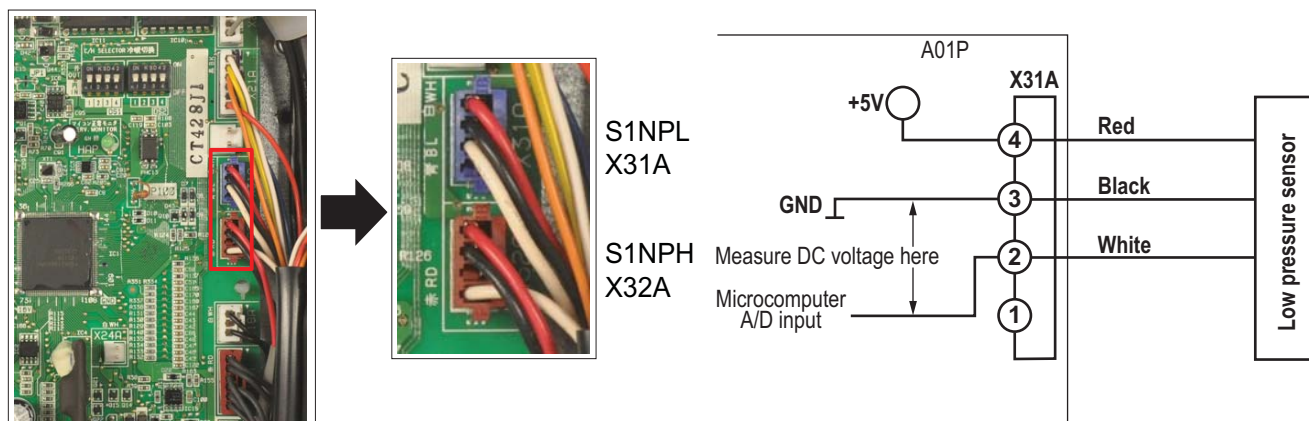

6. Confirm the low pressure sensor read out in mode 1 - code 43 (read out MPa).
7. Replace S1NPL if the measured voltage does not match the expected voltage. Refer to "Replacing a pressure sensor (S1NPH, S1NPL)" on page 147.

High pressure sensor S1NPH

Test in cooling mode

1. Connect a manometer to the service port outdoor liquid (left port).
2. Open the outdoor liquid stop valve.
3. Set the VRV4 in cooling mode and read the pressure.
4. From the graph in [Figure 4 on page 88](#), determine the expected sensor output signal.
5. Measure the voltage on connector X32A, pin 3 (GND) and pin 1, compare the measured voltage with the expected voltage. A tolerance of 0.1 Vdc is allowed.

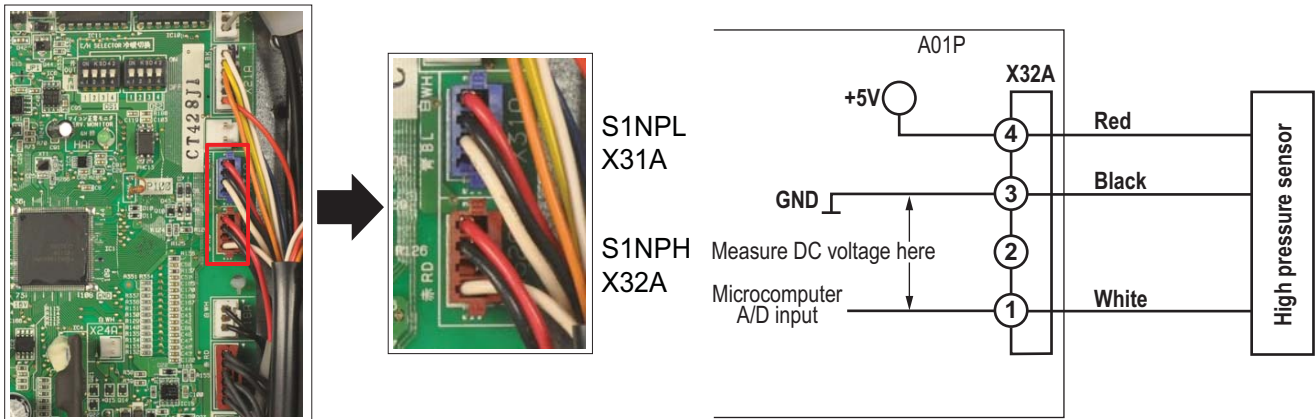

6. Confirm the high pressure sensor read out in mode 1 - code 42 (read out MPa).
7. Replace S1NPH if the measured voltage does not match the expected voltage. Refer to ["Replacing a pressure sensor \(S1NPH, S1NPL\)" on page 147](#).

Test in heating mode

1. Connect a manometer to the service port outdoor discharge (right port).
2. Open the outdoor discharge stop valve.
3. Set the VRV4 in heating mode and read the pressure.
4. From the graph in [Figure 4 on page 88](#), determine the expected sensor output signal.
5. Measure the voltage on connector X32A, pin 3 (GND) and pin 1, compare the measured voltage with the expected voltage.
6. Confirm the low pressure sensor read out in mode 1 - code 43 (read out MPa).
7. Replace S1NPH if the measured voltage does not match the expected voltage. Refer to ["Replacing a pressure sensor \(S1NPH, S1NPL\)" on page 147](#).

Example S1NPH

- The manometer reads 0.75 MPa.
- According to the [Figure 4 on page 88](#), this corresponds with a sensor output voltage of 1.75 Vdc.
- The measured voltage on connector X3, pin 3 - 1 is 1.83 VDC, this is inside the tolerance of 0.1 Vdc.

Figure 4 - Pressure sensor S1NPL, S1NPH output voltage

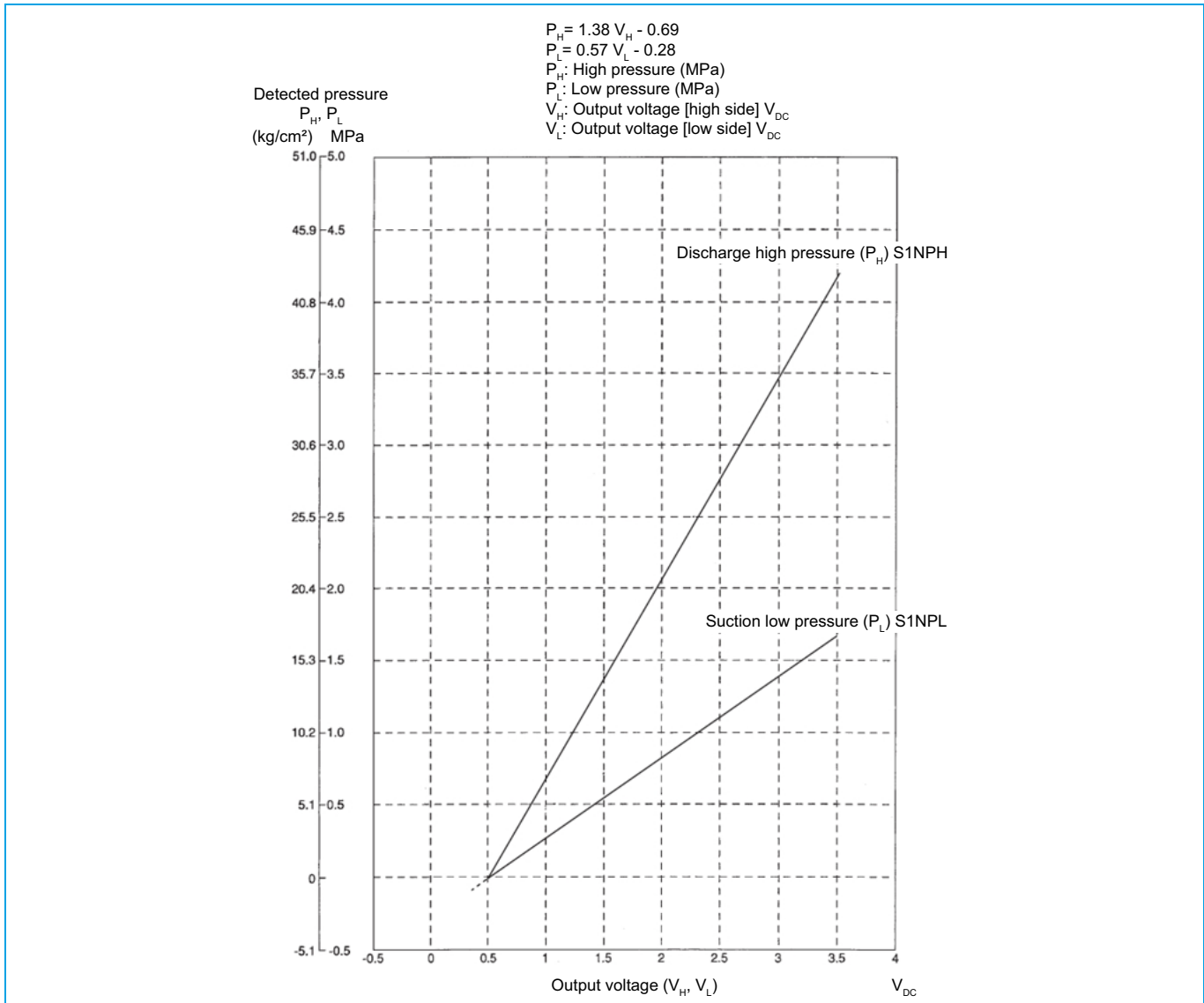

5.10. Pressure switches S1PH, S2PH

Technical specification		Description
<p>The high pressure sensor S1PH and S2PH have a normally closed contact. If the pressure exceeds 4.0 MPa the contact will open; if the pressure drops below 3.0 MPa the contact will close.</p>		<p>Pressure switch S1PH: protection of discharge pressure compressor M1C. Cut off ≥ 4.0 MPa (+0.0 / -0.12), cut in < 3.0 MPa (± 0.15 MPa).</p> <p>Pressure switch S2PH: protection of discharge pressure compressor M2C. Cut off ≥ 4.0 MPa (+0.0 / -0.12), cut in < 3.0 MPa (± 0.15 MPa).</p>
Location		
Wiring diagram	Switch box	Unit
REMQ5T7Y1B, REYQ8T7Y1B, REYQ10T7Y1B, REYQ12T7Y1B		
REYQ14T7Y1B, REYQ16T7Y1B, REYQ18T7Y1B, REYQ20T7Y1B		

Check procedure

Electrical check

1. Switch off the Daikin VRV indoor units via the user control system (indoor control or central control device). Wait until the outdoor unit stops: when no more thermostat demand exists, outdoor may perform pump down operation.
2. Remove the front plate assembly, refer to ["Removing the front plate assembly" on page 102](#).



WARNING: RISK OF ELECTROCUTION.

3. Remove the switch box cover, refer to ["Removing the switch box cover" on page 103](#) (REMQ5T7Y1B, REYQ8~12T7Y1B) or ["Removing the switch box cover" on page 111](#) (REYQ14~20T7Y1B).
4. Remove the lower front plate assembly, refer to ["Removing the switch box cover" on page 103](#)
5. Connect a manometer to the service port outdoor liquid (left port).
6. Open the outdoor liquid stop valve and read the pressure
7. Disconnect the plug from connector X2A from A1P and measure the resistance of the switch S1PH.
 - if the measured pressure is below 3,0 MPa the switch S2PH resistance must be 0 Ω (= closed contact).
 - If the switch S1PH is open it must be replaced. Refer to ["Replacing a pressure switch \(S1PH, S2PH\)" on page 149](#).
8. (REYQ14~20T7Y1B only) Disconnect the plug from connector X3A from A1P and measure the resistance of the switch S2PH.
 - if the measured pressure is below 3,0 MPa the switch S2PH resistance must be 0 Ω (= closed contact).
 - If the switch S2PH is open it must be replaced. Refer to ["Replacing a pressure switch \(S1PH, S2PH\)" on page 149](#).
9. When plug X2A and X3A are connected and power supply is present:
 - Measure the voltage between each terminal of plug X2A, X3A and 0 VDC, the voltage should be = 16 VDC.
 - If the test in step 7 (and 8 for REYQ14~20T7Y1B only) passed and no voltage is measured between X2A,X3A and 0 VDC, PCB A1P needs to be replaced. Refer to ["Procedure: replacing the A1 PCB \(Main\)" on page 125](#).

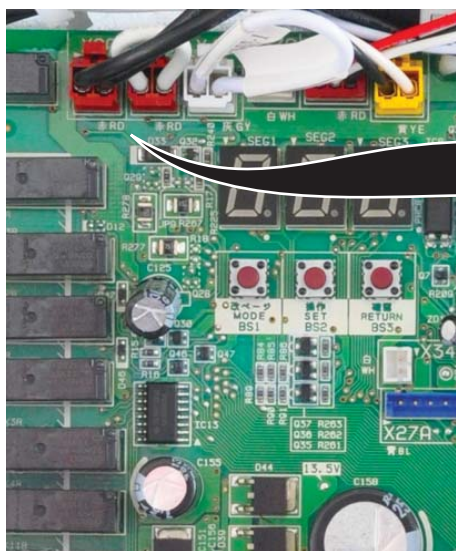

Pressure switch S1PH
(REMQ5T7Y1B,
REYQ8~12T7Y1B)



Pressure switch S2PH
(REYQ14~20T7Y1B)



5.11. Crankcase heater E1HC, E2HC

Technical specification		Description
<p>The crankcase heater is an electric 240V, 33 Watt heater. both compressor types are equipped with the same heater.</p>		<p>Crankcase heater for M1C / M2C (REYQ14~20T7Y1B only)</p> <p>When compressor M1C / M2C is not operating and the discharge temperature is less than 70°C, the crankcase heater is switched on to ensure that the oil is heated up to limit refrigerant to dissolve into the oil.</p> <p>When there is high amount of refrigerant dissolved into the compressor oil, during operation of the compressor, oil foams heavily. Oil foam results in poor lubrication and oil is discharged quickly outside the compressor. Oil foam will result into compressor failure (locked mechanism).</p>
Location		
Wiring diagram	Switch box	Unit
REMQ5T7Y1B, REYQ8T7Y1B, REYQ10T7Y1B, REYQ12T7Y1B		
REYQ14T7Y1B, REYQ16T7Y1B, REYQ18T7Y1B, REYQ20T7Y1B		

Check procedure

Electrical check

Check connectors unplugged

1. Disconnect the plug from connector X11A (E1HC) and X12A (E2HC, REYQ14~20T7Y1B only).
2. Measure the resistance of E1HC and E2HC (REYQ14~20T7Y1B only).
3. The measured resistance must be 1.8 K Ω (\pm 7%).
4. Replace E1HC or E2HC (REYQ14~20T7Y1B only) if the measured resistance does not match the expected resistance. Refer to ["Replacing a crankcase heater E1HC, E2HC" on page 174](#).
5. Perform a Megger test (minimum 500 V) on E1HC and E2HC (REYQ14~20T7Y1B only).
6. The isolation resistance must exceed 1 M Ω . If not, the crankcase heater(s) must be replaced. Refer to ["Replacing a crankcase heater E1HC, E2HC" on page 174](#).

Check connectors reconnected to the compressor

1. Switch off the Daikin VRV indoor units via the user control system (indoor control or central control device).
2. Remove the front plate assembly, refer to ["Removing the front plate assembly" on page 102](#).



WARNING: RISK OF ELECTROCUTION.

3. Remove the switch box cover, refer to ["Removing the switch box cover" on page 103](#) (REMQ5T7Y1B, REYQ8~12T7Y1B) or ["Removing the switch box cover" on page 111](#) (REYQ14~20T7Y1B).
4. Switch on the Daikin Altherma GSHP via the user interface.
5. Measure the voltage on X11A (E1HC) and X12A (E2HC for REYQ14~20T7Y1B only). The normal voltage is 240 VAC.

**INFORMATION****The crankcase heater is only powered when:**

- the compressor inverter board output UVW = 0 Hz **and** the compressor discharge temperature < 70°C.

The crankcase heater is powered off when:

- the compressor inverter board output UVW > 0 Hz or when the compressor inverter board output UVW = 0 Hz **and** the compressor discharge temperature compressor > 75°C.

6. Open the insulation of the compressor by pulling the velcro strips.

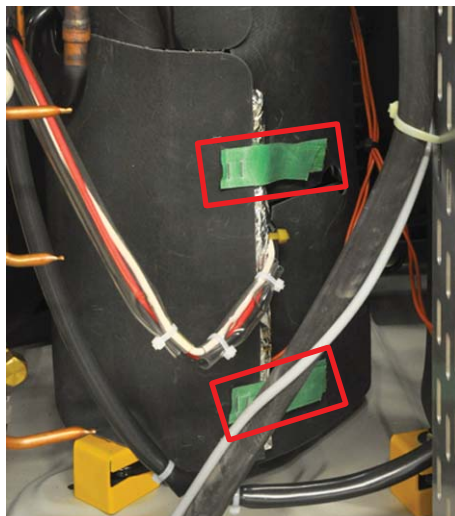

7. Check that crankcase heater(s) is (are) heating when powered. If not, the crankcase heater(s) must be replaced. Refer to ["Replacing a crankcase heater E1HC, E2HC" on page 174.](#)



Part 3. Repair

1. General Repair procedures

Refrigerant handling procedures	95	Products	98
Pipe work procedures	98	Tools.....	99

1.1. Refrigerant handling procedures

- Make sure the applied pressure is never higher than the unit design pressure as indicated on the nameplate.
- Work according the F-gas regulation and/or local regulations.
- Make sure the correct amount (factory + additional where required) of refrigerant is charged after repair. Consult the log book if available.
- Make sure to use the appropriate equipment and tools according to the refrigerant and unit type.
- Charge non-azeotropic refrigerant (e.g. R-410A) always in a liquid state.
- Make sure to use a digital scale (no charging cylinder).
- Execute correct vacuum drying procedure after repair work:
 - -0,1 MPa / -760 mmHg / -750 Torr for at least 1 hour.
 - Use both gas and liquid pipe connection.
 - Use related field setting where necessary.

1.1.1. Refrigerant Handling

Refrigerant Action	High Pressure Service Port	Low Pressure Service Port
Recover	x	x
Vacuum	x	x
Charge	x	-

1.1.1.1 Procedure

- 1. Set outdoor 2-21-1, BS3 "return" press 2x => indication "t01.

Refrigerant recovery mode (2-21-1)

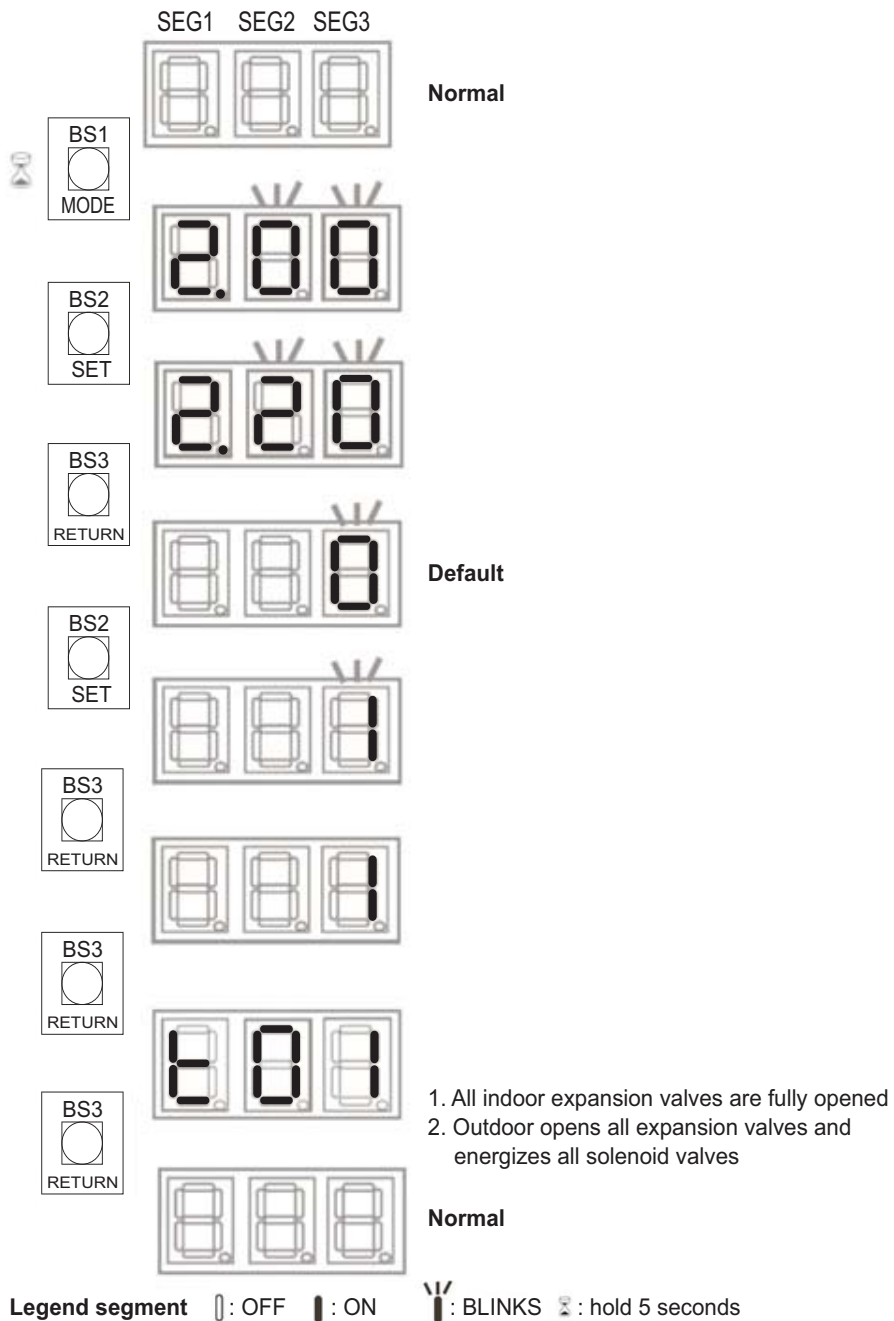

2. Connect vacuum pump, manifold, recovery unit and refrigerant bottle to layout below.

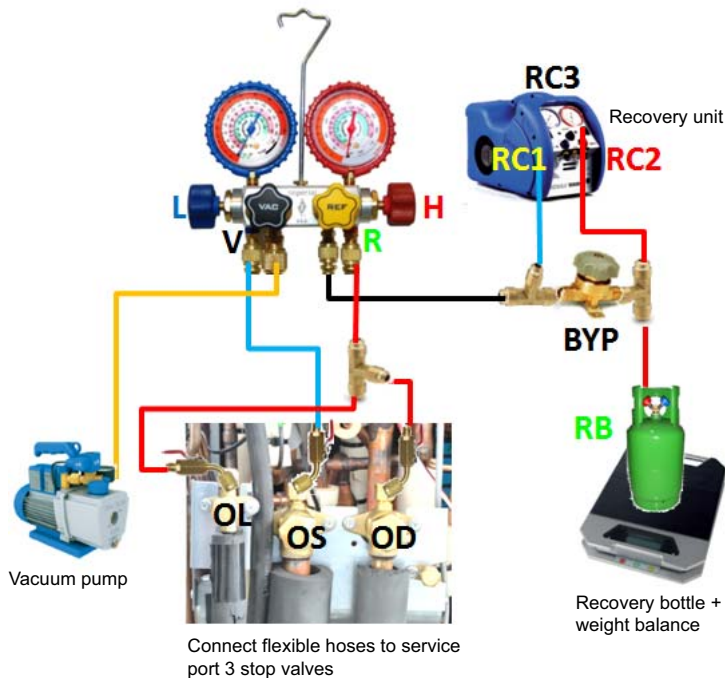

Purpose	Service port outdoor			Valve manifold					Valve recovery unit			Valve bottle	Operate	
	OL	OS	OD	L	V	R	H	BYP	RC1	RC2	RC3	RB	VP	RU
Connections	C	C	C	C	C	C	C	C	C	C	Rec	C	×	×
Vacuuming	C	C	C	O	O	O	O	O	O	O	Rec	C	✓	×
End vacuuming	C	C	C	O	C	O	O	C	O	O	Rec	O	×	×
Recover liquid	O	O	O	C	C	O	O	C	1/2	O	Rec	O	×	✓
Recover gas	O	O	O	O	C	O	O	C	O	O	Rec	O	×	✓
Purge	O	O	O	C	C	C	C	C	*	O	Pur	O	×	✓
Disconnect	C	C	C	C	C	C	C	C	C	C	Rec	C	×	×
End recovery	Press button BS3 "return" 1x => indication blank (normal)												×	×

OL= outdoor liquid, OS= outdoor suction, OD= outdoor discharge, C= closed, O= open, 1/2: between indication "liquid" & "gas", Rec= recovery, Pur: purge, VP= vacuum pump, RU= recovery unit, * Change Inlet valve RC1 gradually to "purge" when pressure drops

1.2. Pipe work procedures

- Make sure to cover open pipe ends during work so no dust or moisture can enter.
- Make sure to re-apply insulation removed during repair.
- Pipe expansion / flare making:
 - Remove any burrs on the cut surface and use correct tool such as reamer or scraper (note that excessive deburring can thin the pipe walls and cause cracking of the pipe).
 - Make sure the flare has the correct size (use a flare gauge).
 - Make sure no particles remain in the piping.
 - Apply refrigerant oil on the inner surface of the flare.
 - Make sure the flare connection is tightened with the correct torque (torque values refer to installation manual).
- Brazing:
 - Use correct brazing tool.
 - Use a phosphor copper filler metal (silver composition of 0 to 2%). Do not use flux material.
 - Use nitrogen replacement in order to prevent oxide film from forming (nitrogen purity $\geq 99,99\%$).
 - Do not stop the nitrogen gas until the refrigerant piping has completely cooled down.

1.3. Products

1.3.1. Required products when servicing the VRV4 Heat recovery system

When the cooling tube of the inverter(s) has been removed, heat sink compound (1) must be applied.

Figure 5 - Required product



1. Heat sink compound (Part number 5013817))

1.4. Tools

1.4.1. Required special tooling when servicing the VRV4 Heat recovery system

Daikin strongly recommends to use special tools to avoid damage to the equipment or to facilitate the replacement of certain spare parts.

Figure 6 - Required tools

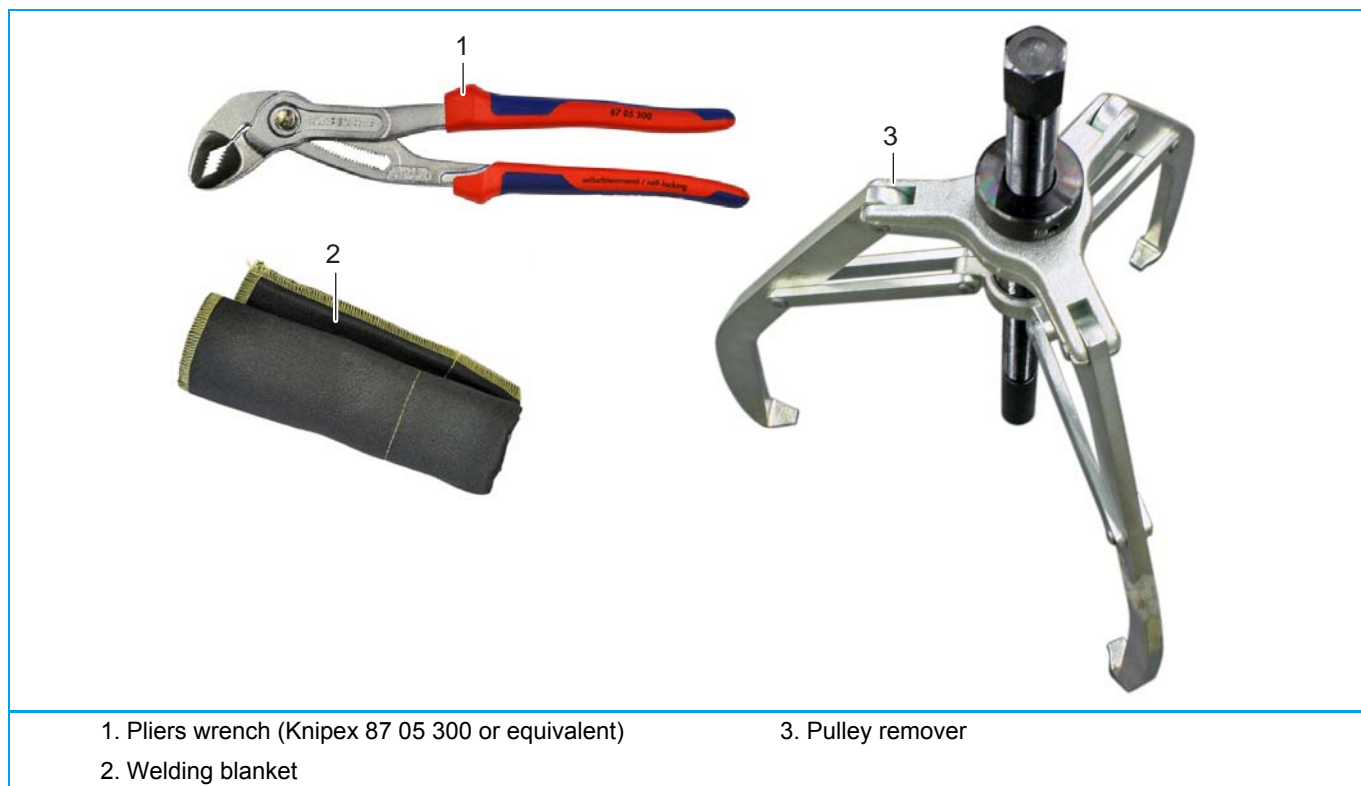

2. Preliminary actions procedures

Removing bodywork (REMQ5T7Y1B, REYQ8~12T7Y1B)	100	Tilting the main and sub board assembly and the power terminal assembly (REMQ5T7Y1B, REYQ8~12T7Y1B)	122
Removing bodywork (REYQ14~20T7Y1B)	108	Unlocking a PCB.....	123
Checking the rectifier voltage	117	Displacing a bracket	124
Tilting the inverter mounting plate (REYQ14~20T7Y1B).....	118		
Removing the inverter mounting plate (REYQ14~20T7Y1B).....	120		

2.1. Removing bodywork (REMQ5T7Y1B, REYQ8~12T7Y1B)

2.1.1. Removing the service plate assembly

1. Loosen and remove the 2 screws (1) that fix the service plate assembly (2).
2. Remove the service plate assembly (2) from the unit.

Figure 7 - Removing the service plate assembly



1. Screw

2. Service plate assembly

2.1.2. Removing the upper front plate assembly

1. Loosen and remove the 7 screws (1) that fix the upper front plate assembly (2).
2. Lift the upper front plate assembly (2) and remove it from the unit.

Figure 8 - Removing the upper front plate assembly

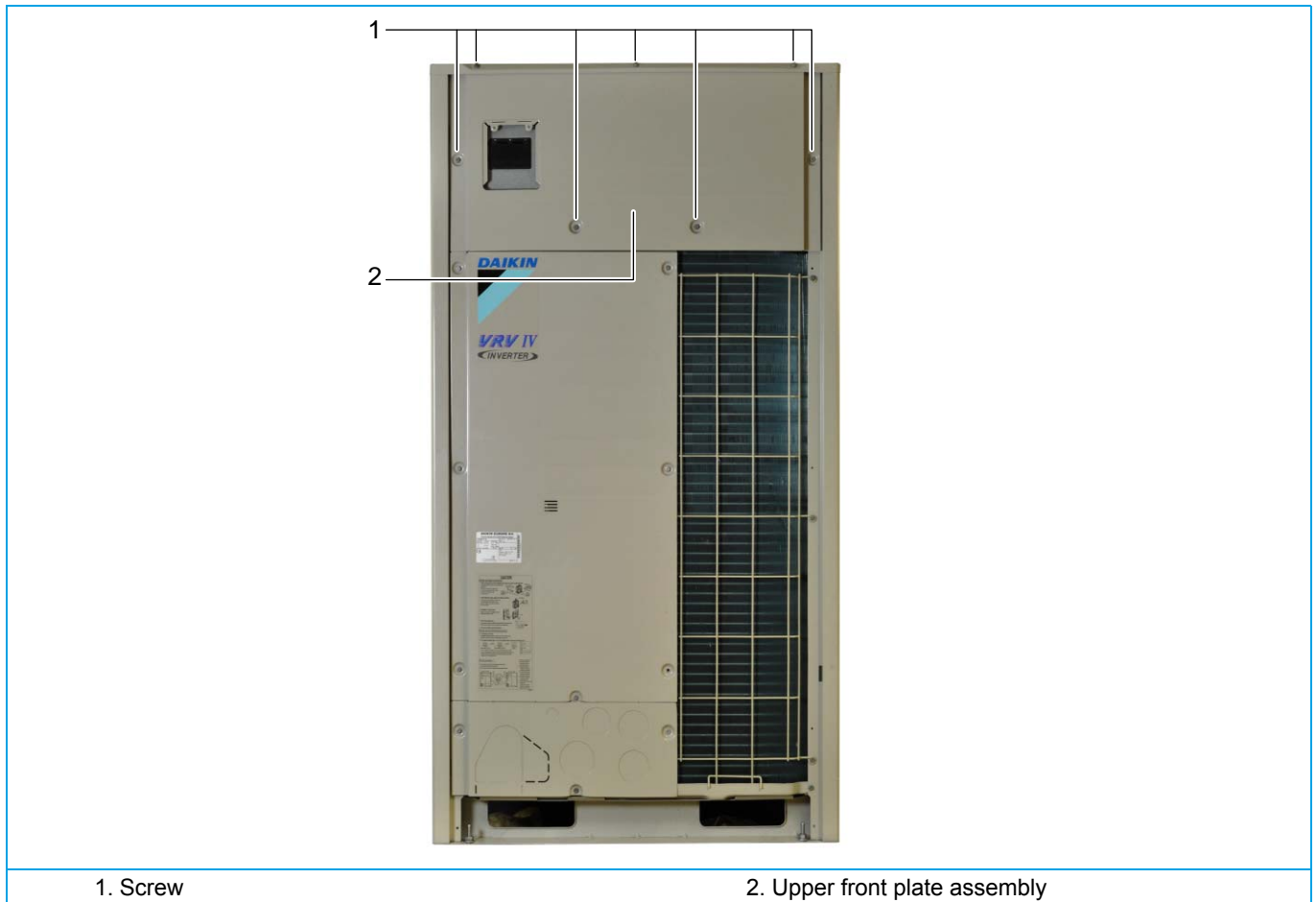

2.1.3. Removing the front plate assembly

1. Loosen and remove the 7 screws (1) that fix the front plate assembly (2).
2. Lift the front plate assembly (2) and remove it from the unit.

Figure 9 - Removing the front plate assembly

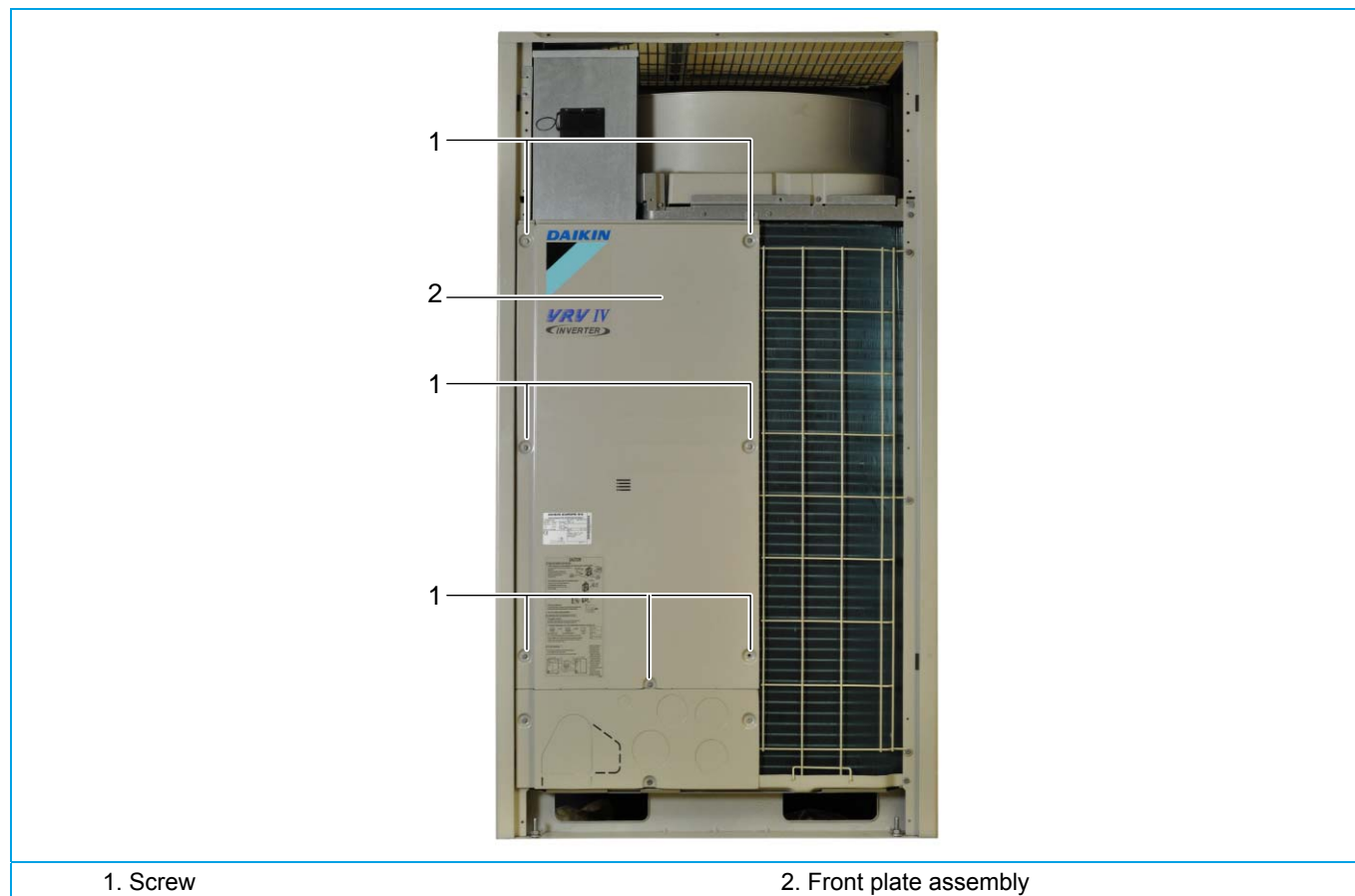

2.1.4. Removing the switch box cover

**WARNING**

Electrical shock hazard. Remove power from the VRV4 Heat recovery system before removing the switch box cover. Do not touch terminals.

1. Switch off the VRV4 Heat recovery system via the indoor controller.
2. Remove the 2 screws (1) that fix the switch box cover (2).
3. Remove the switch box cover (2).

Figure 10 - Removing the switch box cover (REM5T7Y1B, REYQ8~12T7Y1B)

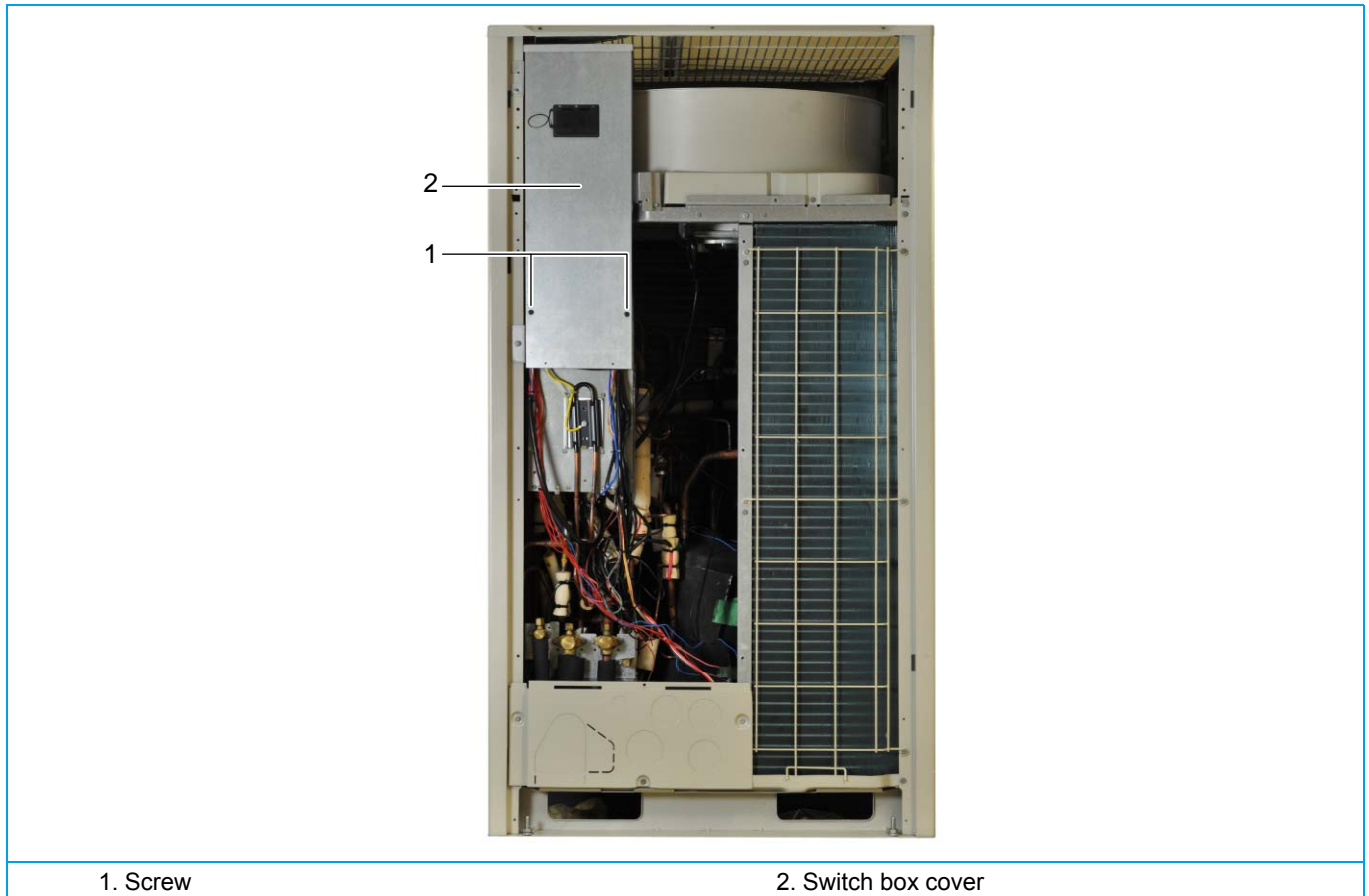

2.1.5. Removing the lower front plate assembly

1. Loosen and remove the 3 screws (1) that fix the lower front plate assembly (2).
2. Lift the lower front plate assembly (2) and remove it from the unit.

Figure 11 - Removing the lower front plate assembly

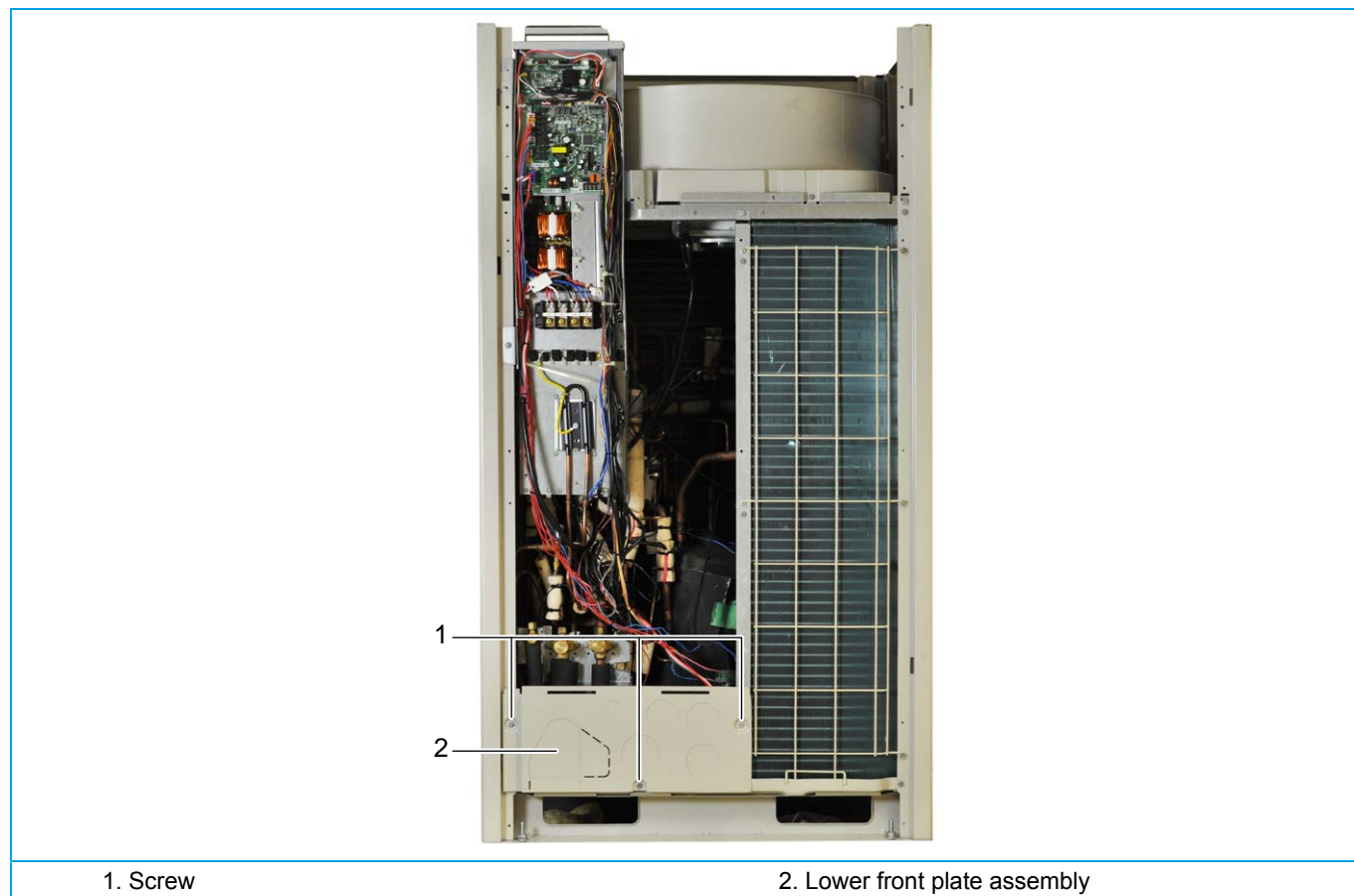

2.1.6. Removing the side plate assembly

1. Loosen and remove the 7 screws (1) that fix the side plate assembly (2).
2. Lift the side plate assembly (2) and remove it from the unit.

Figure 12 - Removing the side plate assembly



2.1.7. Removing the upper side plate assembly



INFORMATION

The procedure is identical for the left and right upper side plate.

1. Loosen and remove the 7 screws (1) that fix the upper side plate assembly (2).
2. Lift the upper side plate assembly (2) and remove it from the unit.

Figure 13 - Removing the upper side plate assembly



1. Screw

2. Upper side plate assembly

2.1.8. Removing the top plate

1. Switch off the VRV4 Heat recovery system via the indoor controller.
2. Loosen and remove the 12 screws (1) that fix the top plate (2).
3. Remove top plate (2) from the unit.

Figure 14 - Removing the top plate

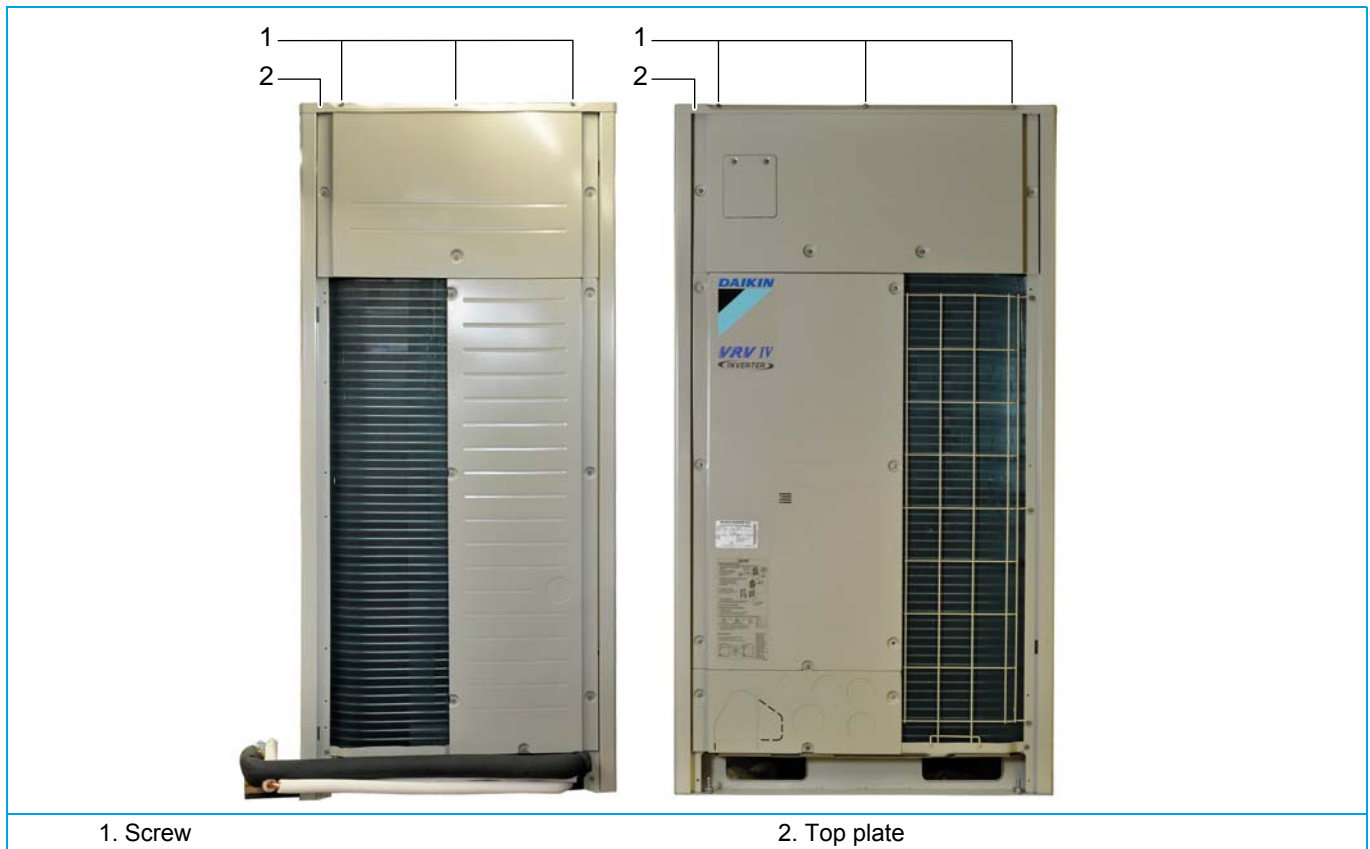

2.2. Removing bodywork (REYQ14~20T7Y1B)

2.2.1. Removing the service plate assembly

1. Loosen and remove the 2 screws (1) that fix the service plate assembly (2).
2. Remove the service plate assembly (2) from the unit.

Figure 15 - Removing the service plate assembly

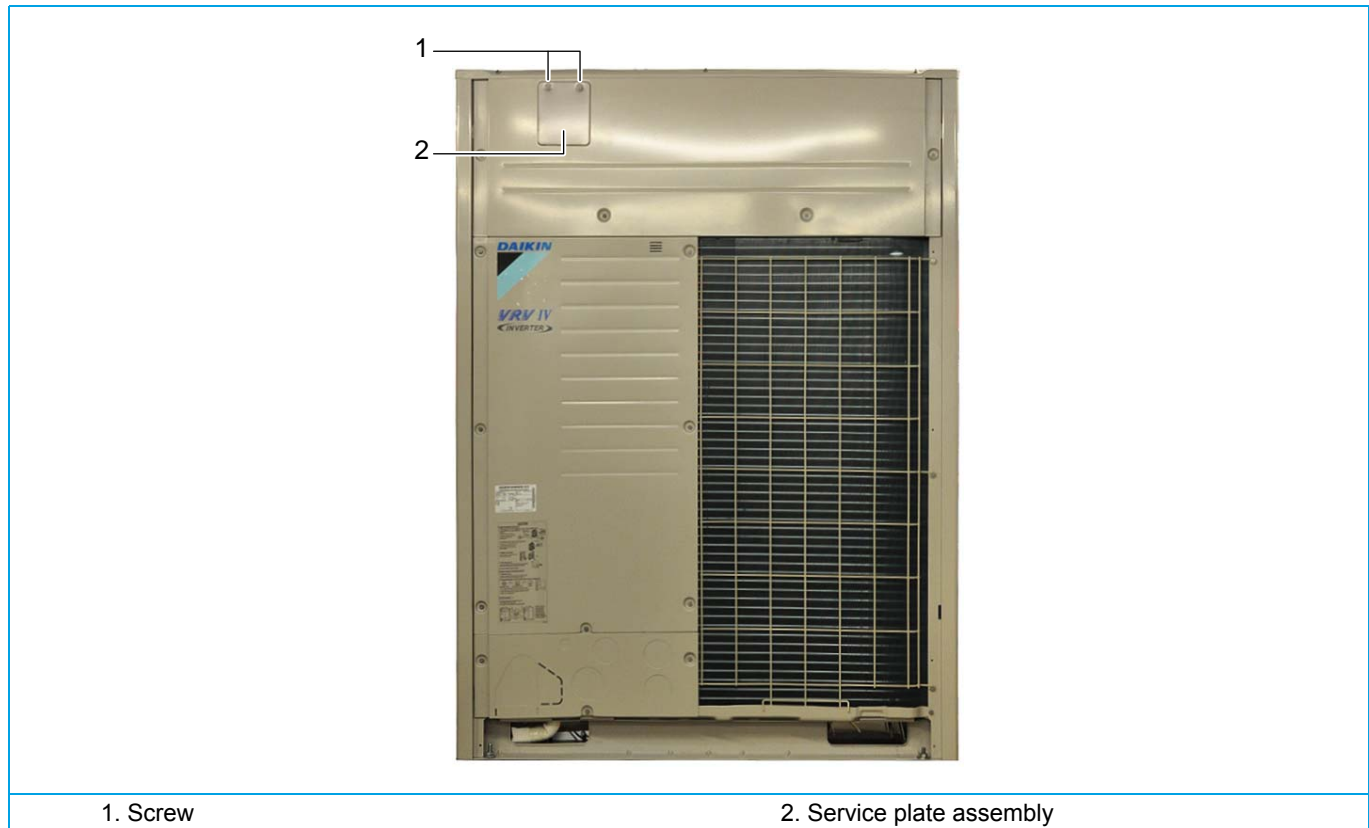

2.2.2. Removing the upper front plate assembly

1. Switch off the VRV4 Heat recovery system via the indoor controller.
2. Loosen and remove the 7 screws (1) that fix the upper front plate assembly (2).
3. Lift the upper front plate assembly (2) and remove it from the unit.

Figure 16 - Removing the upper front plate assembly

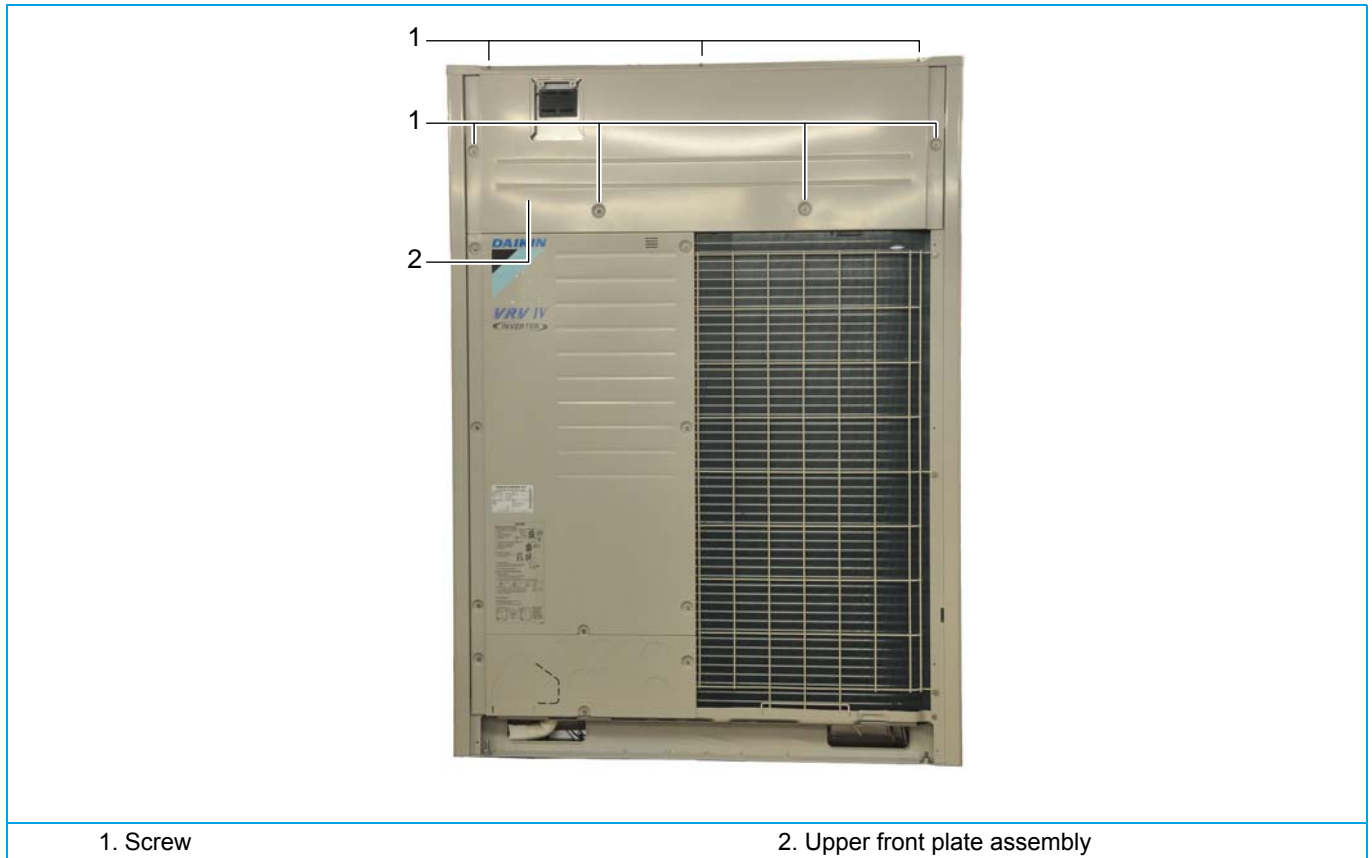

2.2.3. Removing the front plate assembly

1. Loosen and remove the 7 screws (1) that fix the front plate assembly (2).
2. Lift the front plate assembly (2) and remove it from the unit.

Figure 17 - Removing the front plate assembly

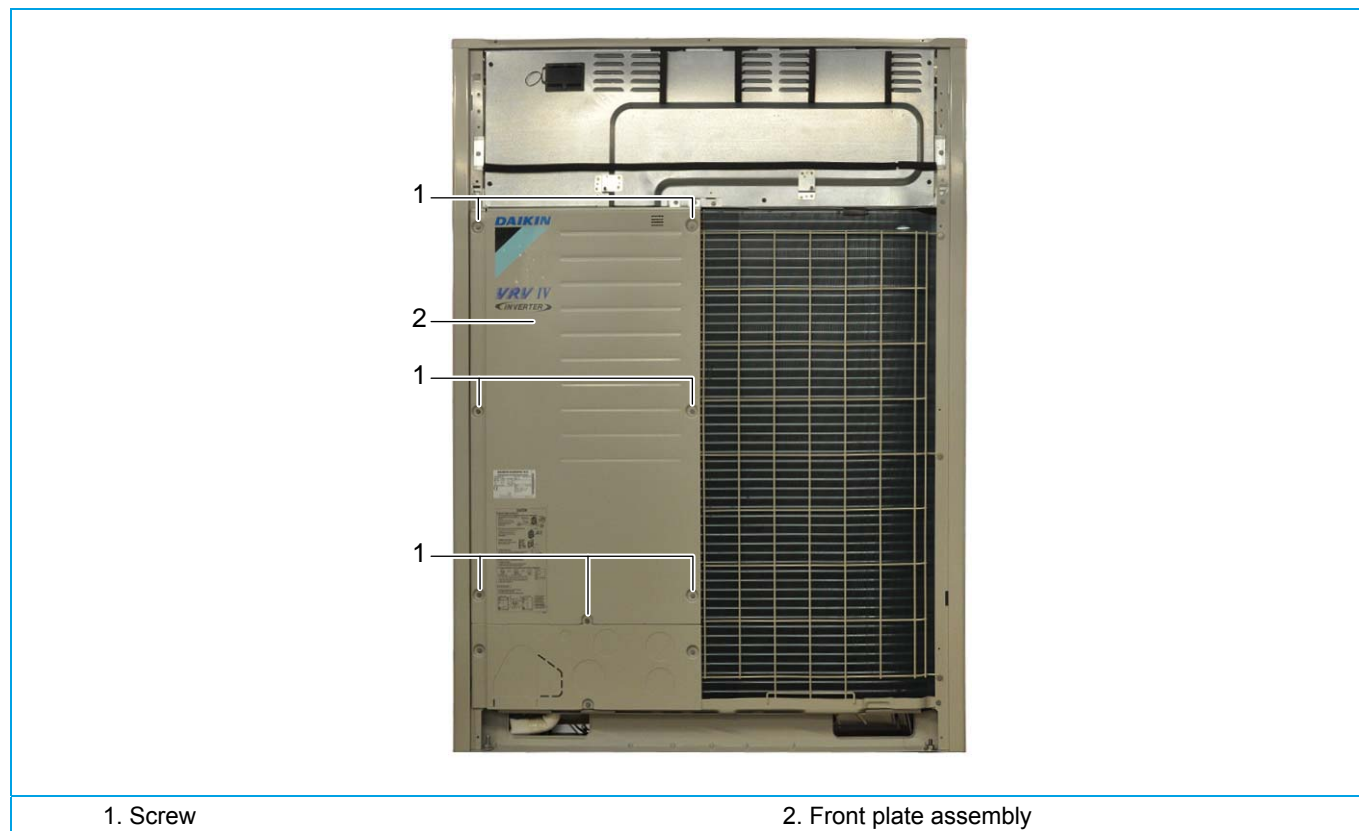

2.2.4. Removing the switch box cover

1. Loosen and remove the 5 screws (1) that fix the switch box cover (2).
2. Tilt the switch box cover (2) and remove it from the unit.

Figure 18 - Removing the switch box cover

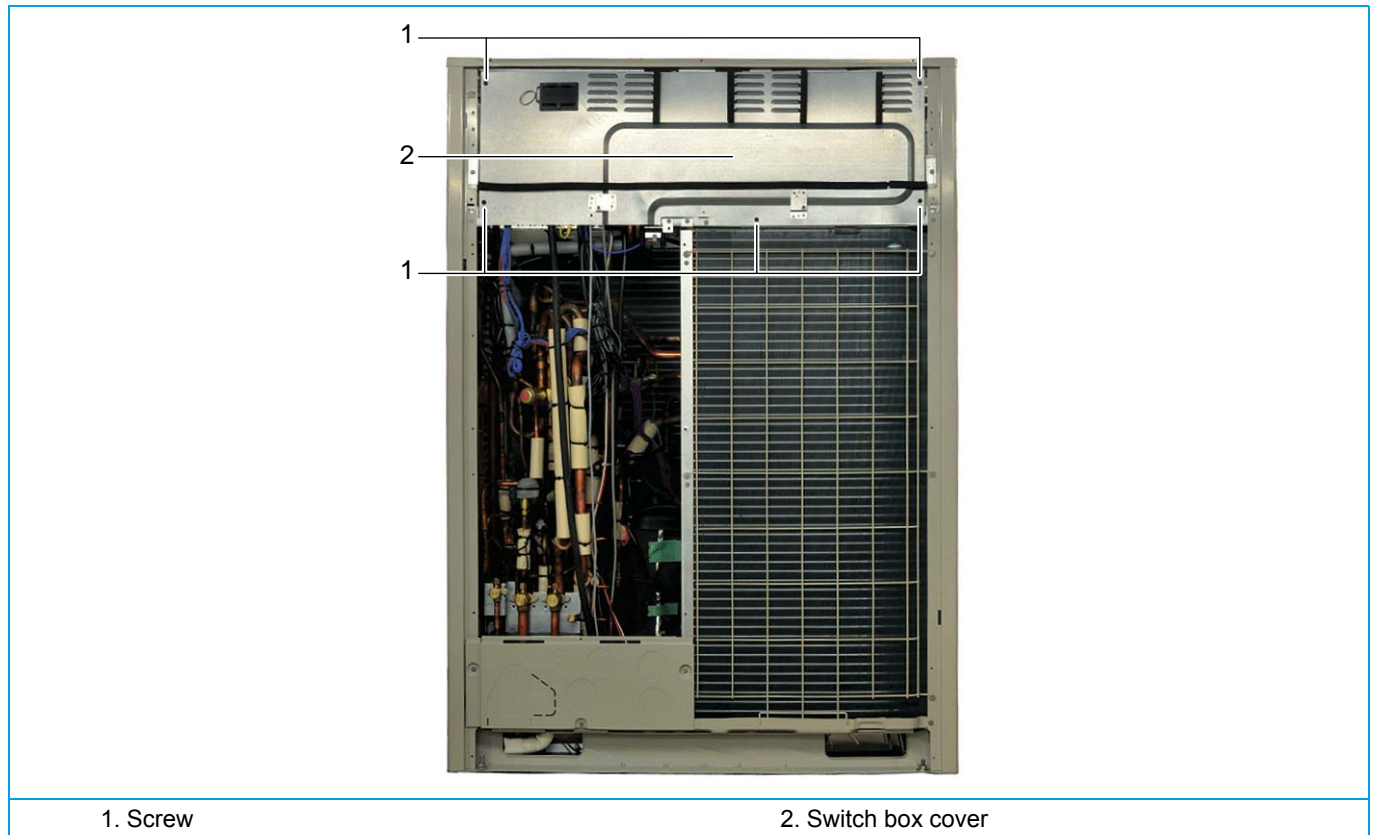

2.2.5. Removing the lower front plate assembly

1. Loosen and remove the 3 screws (1) that fix the lower front plate assembly (2).
2. Slide the lower front plate assembly (2) upwards and remove it from the unit.

Figure 19 - Removing the lower front plate assembly

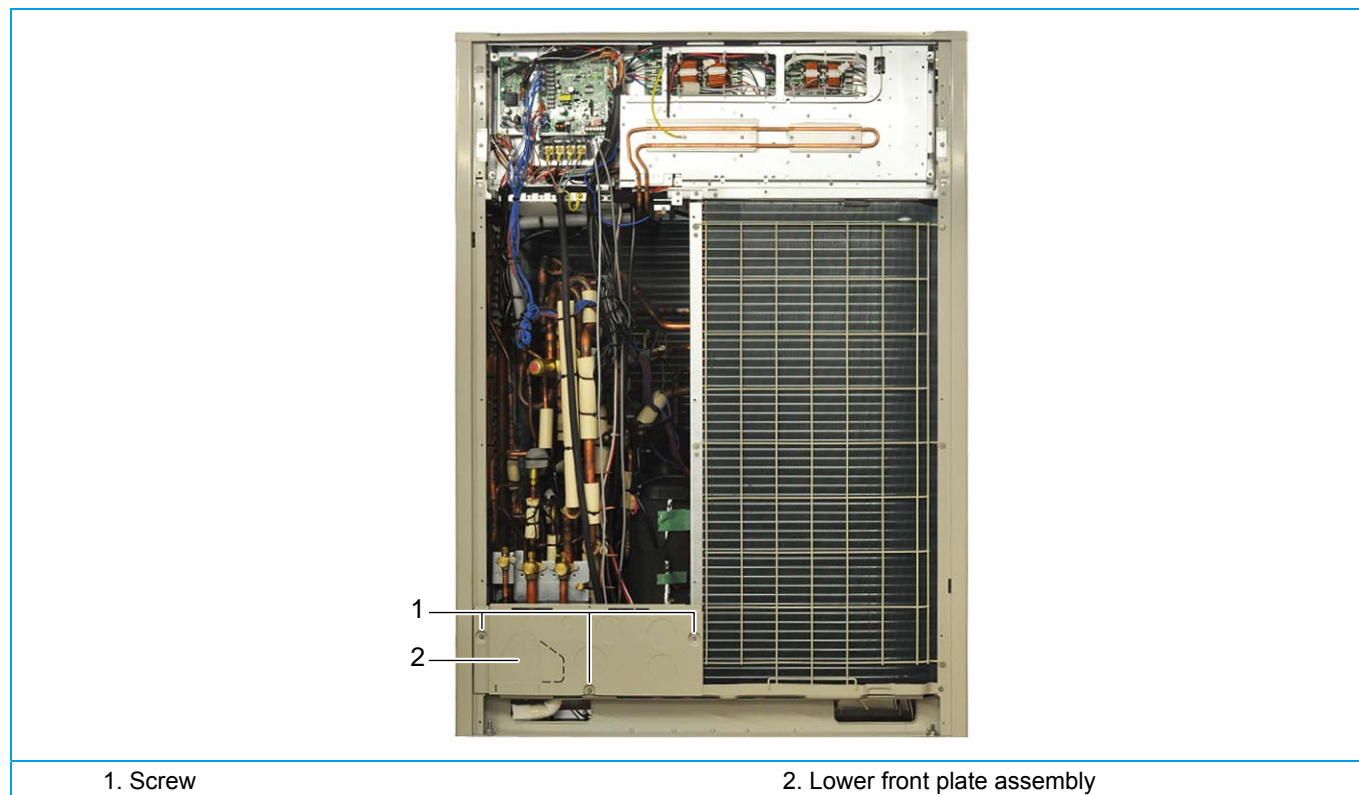

2.2.6. Removing the side plate assembly

1. Loosen and remove the 7 screws (1) that fix the side plate assembly (2).
2. Lift the side plate assembly (2) and remove it from the unit.

Figure 20 - Removing the side plate assembly



2.2.7. Removing the upper side plate assembly

**INFORMATION**

The procedure is identical for the left and right upper side plate.

1. Loosen and remove the 7 screws (1) that fix the upper side plate assembly (2).
2. Lift the upper side plate assembly (2) and remove it from the unit.

Figure 21 - Removing the upper side plate assembly



1. Screw

2. Upper side plate assembly

2.2.8. Removing the top plate

1. Switch off the VRV4 Heat recovery system via the indoor controller.
2. Loosen and remove the 12 screws (1) that fix the top plate (2).
3. Lift the top plate (2) and remove it from the unit.

Figure 22 - Removing the top plate

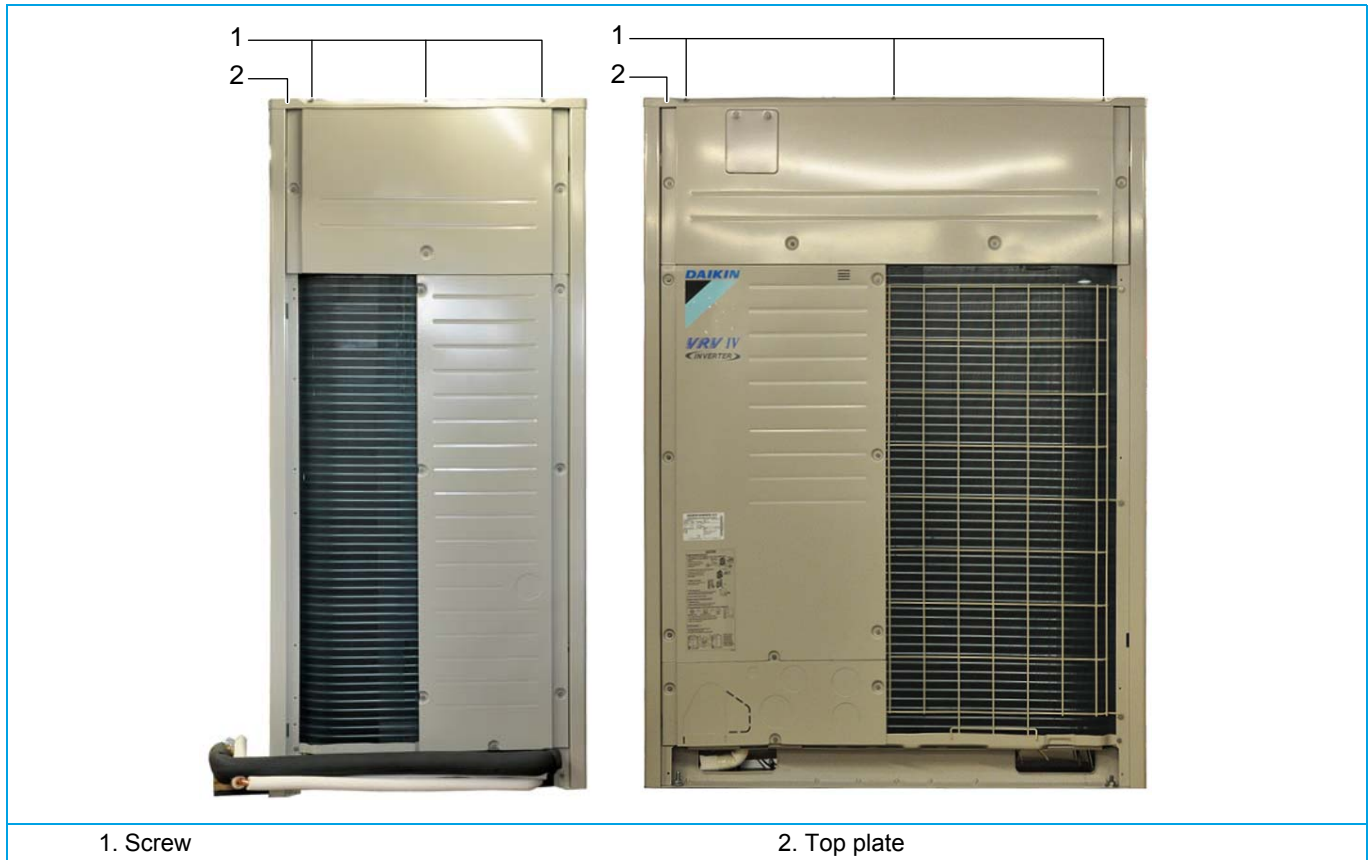

2.3. Removing bodywork (BS unit)

2.3.1. Removing the BS unit cover

**WARNING**

Electrical shock hazard. Remove power from the VRV4 Heat recovery system before removing the switch box cover. Do not touch terminals.

1. Switch off the VRV4 Heat recovery system with the field supplied circuit breaker.
2. Loosen and remove the 4 screws (1) that fix the BS unit cover (2).
3. Remove the BS unit cover (2) from the BS unit.

Figure 23 - Removing the BS unit cover

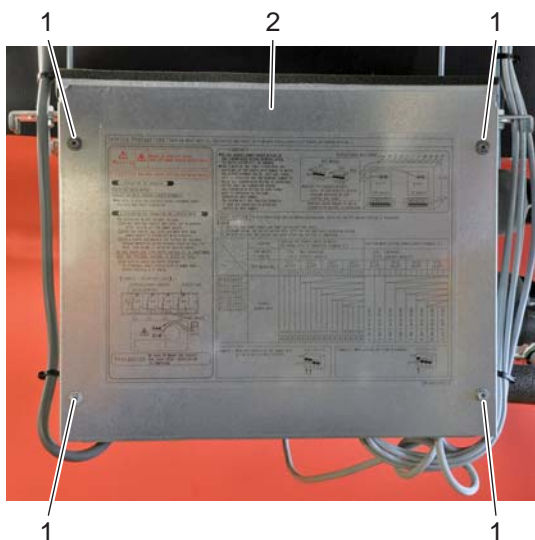

1. Screw



2. BS unit cover

2.4. Checking the rectifier voltage



WARNING

Electrical shock hazard. Remove power from the VRV4 Heat recovery system before removing the switch box cover. Do not touch terminals.

1. Switch off the VRV4 Heat recovery system with the field supplied circuit breaker.
2. Remove the switch box cover, refer to "[Removing the switch box cover](#)" on page 103 (REMQ5T7Y1B, REYQ8~12T7Y1B) or "[Removing the switch box cover](#)" on page 111 (REYQ14~20T7Y1B).
3. Measure the voltage on connector X3A (REMQ5T7+REYQ8~12T7) or X5A/X6A (REYQ14~20T7), wait until the voltage drops below 10 V before proceeding.

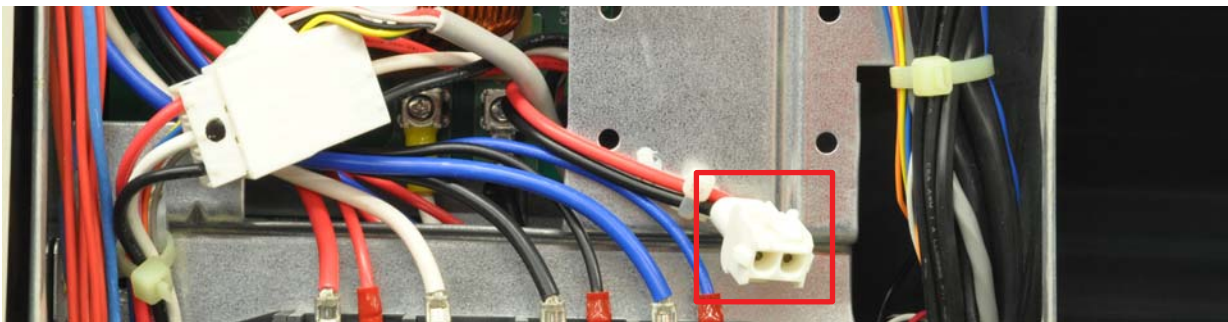

REMQ5T7Y1B, REYQ8T7Y1B, REYQ10T7Y1B, REYQ12T7Y1B

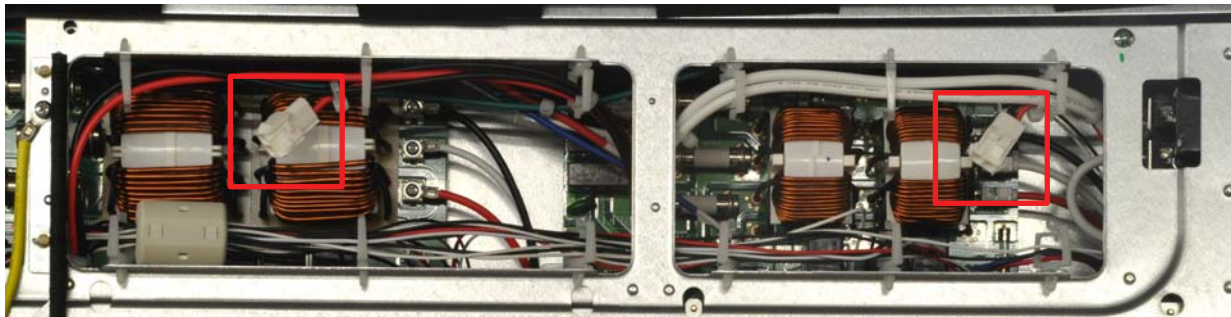

REYQ14T7Y1B, REYQ16T7Y1B, REYQ18T7Y1B, REYQ20T7Y1B

2.5. Tilting the inverter mounting plate (REYQ14~20T7Y1B)



WARNING

Electrical shock hazard. Remove power from the VRV4 Heat recovery system before removing the switch box cover. Do not touch terminals.

1. Switch off the VRV4 Heat recovery system with the field supplied circuit breaker.
2. Remove the switch box cover, refer to or "[Removing the switch box cover](#)" on page 111.
3. Measure the rectifier voltage and wait until the voltage drops below 10 V before proceeding, refer to "[Checking the rectifier voltage](#)" on page 117.



CAUTION

Do NOT loosen the screws (1) that fix the A3P / A6P inverter boards at this stage. These screws (1) must only be removed when replacing an inverter board, refer to "[Replacing the compressor inverter board A3P \(type 1 \(G\) compressor\) \(REYQ14~20T7Y1B\)](#)" on page 135 or "[Replacing the compressor inverter board A6P \(type 2 \(J\) compressor\) \(REYQ14~20T7Y1B\)](#)" on page 138.

4. Loosen and remove the 4 screws (2) that fix the heat sinks.
5. Loosen and remove the short screw (3) that fixes the grounding wire to the heat sinks
6. Loosen and remove the screw (6) that fixes the R1T support.



INFORMATION

Thermal grease is applied to the heat sinks. Use gloves when separating the heat sinks from the inverter boards.

7. Using a screwdriver, carefully separate both heat sinks from the inverter boards.
8. Loosen and remove the 6 screws (4) that fix the inverter mounting plate (5).

Figure 24 - Unlocking the inverter mounting plate

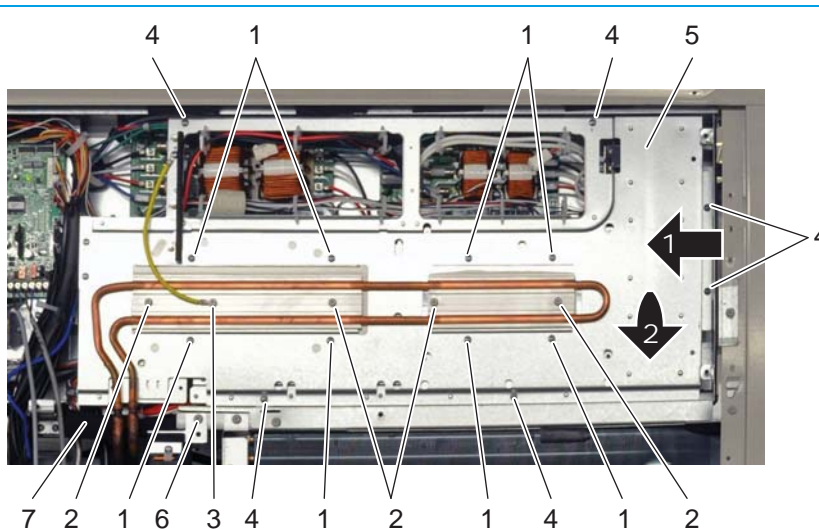

- | | |
|----------------|----------------------------|
| 1. Screw | 4. Screw |
| 2. Screw | 5. Inverter mounting plate |
| 3. Short screw | 6. Screw |

9. Carefully pull the inverter mounting plate (1) to the left and tilt it.

Figure 25 - Tilting the inverter mounting plate

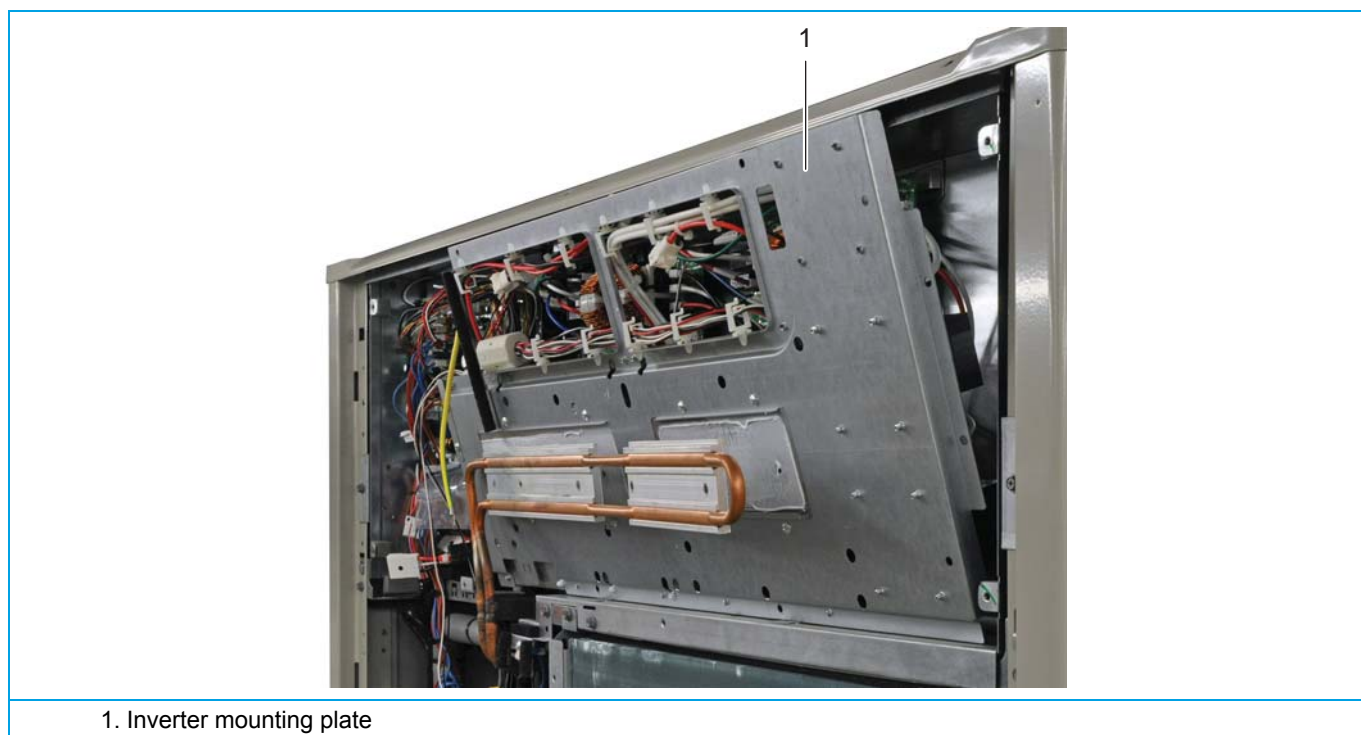

2.6. Removing the inverter mounting plate (REYQ14~20T7Y1B)



WARNING

Electrical shock hazard. Remove power from the VRV4 Heat recovery system before removing the inverter mounting plate.
Do not touch terminals.

1. Switch off the VRV4 Heat recovery system with the field supplied circuit breaker.
2. Unplug the Faston plugs (or loosen and remove screw connectors) power in L1A, L2A, L3A, NA, E (1) from A2P / A5P (5).
3. Unplug X402A (2) (not for J-type compressor).
4. Unplug X403A (3).
5. Unplug Faston plugs (or loosen and remove screw connectors) power out L1B, L2B, L3B (4).

Figure 26 - Unplugging the A2P / A5P PCB wiring (Noise filter)

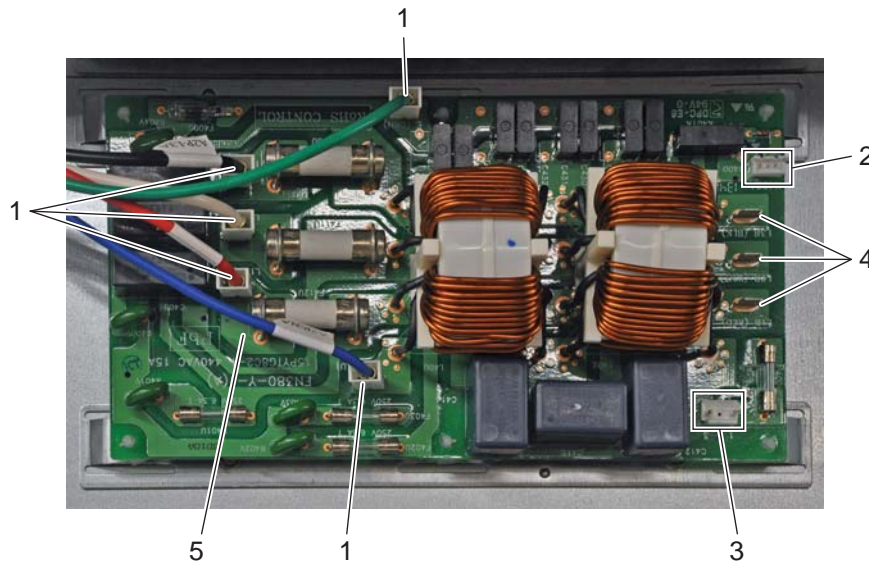

1. L1A, L2A, L3A, NA, E
2. X402A
3. X403A

4. L1B, L2B, L3B
5. A2P / A5P PCB

6. Unplug connectors X1A (1), X2A (2), X3A (red) (3) and X4A (red) (4).

Figure 27 - Unplugging the fan wiring

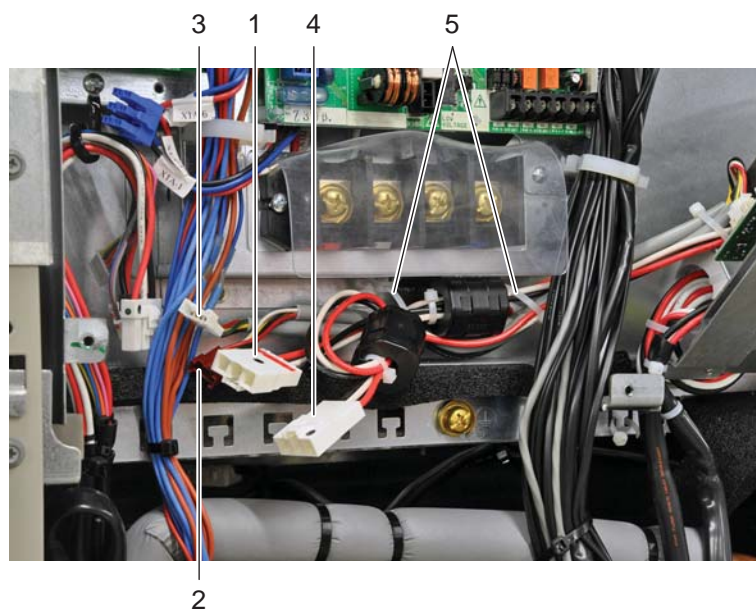

- | | |
|--------------|--------------|
| 1. X1A | 4. X4A (red) |
| 2. X2A | 5. Tie wrap |
| 3. X3A (red) | |

7. Cut the tie wraps (5) that fix the compressor wiring to the chassis.



CAUTION

The inverter mounting plate will be placed in front of the VRV4, this is only allowed in dry conditions. If dry conditions cannot be guaranteed, the compressor cables have to be removed from the compressor (see §3.15) and the inverter mounting plate must be taken inside.

8. Unplug connector X3A from the A3P / A8P PCB (sub).
9. Unplug connectors X28A, X40A and X41A from the A1P PCB (main).
10. Cut the tie wraps that fixes the wiring mentioned in the previous step.
11. Lift the inverter mounting plate over the heat sinks and place it in front of the VRV4.

2.7. Tilting the main and sub board assembly and the power terminal assembly (REM5T7Y1B, REYQ8~12T7Y1B)



WARNING

Electrical shock hazard. Remove power from the VRV4 Heat recovery system before removing the switch box cover. Do not touch terminals.



INFORMATION

Tilting the main and sub board assembly and the power terminal assembly is required when servicing the noise filter. The wiring from the main and sub board is not removed.

1. Remove the switch box cover, refer to "Removing the switch box cover" on page 103.
2. Remove the 4 screws (1) that fix the main and sub board assembly (5).
3. Remove the 3 screws (2) that fix the power terminal assembly (6).
4. Slightly tilt the main and sub board assembly (5) to gain access to the power input wiring (3) on the noise filter board (4).
5. Remove the power input wiring (3) from the noise filter board (4).
6. Completely tilt the main and sub board assembly (5) to get full access to the noise filter board (4).

Figure 28 - Unlocking and tilting the main and sub board assembly (REM5T7Y1B, REYQ8~12T7Y1B)

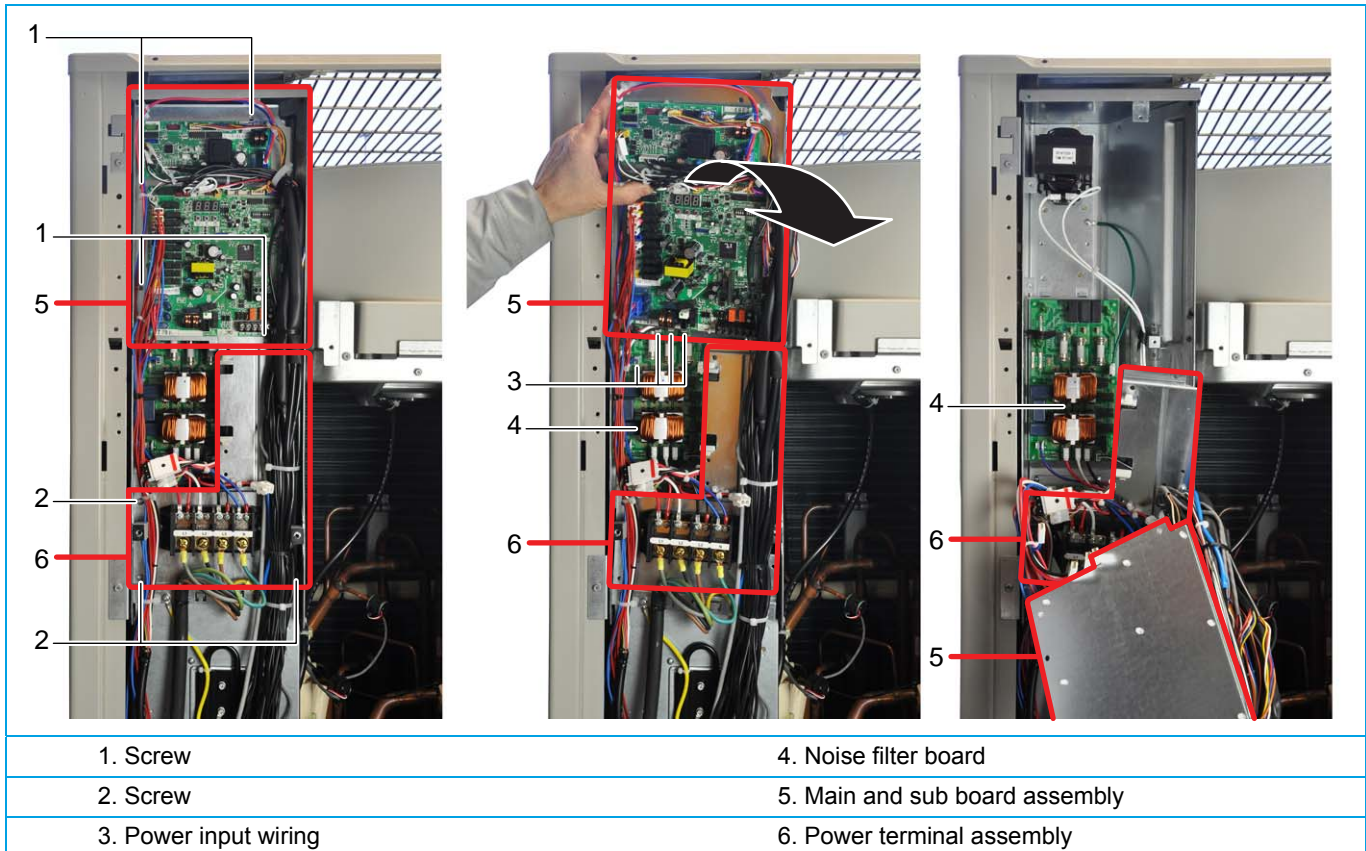

2.8. Unlocking a PCB

1. Carefully pull the PCB at the side and unlatch all the pcb supports (1) one by one using a small pliers.

Figure 29 - PCB spacer unlatching

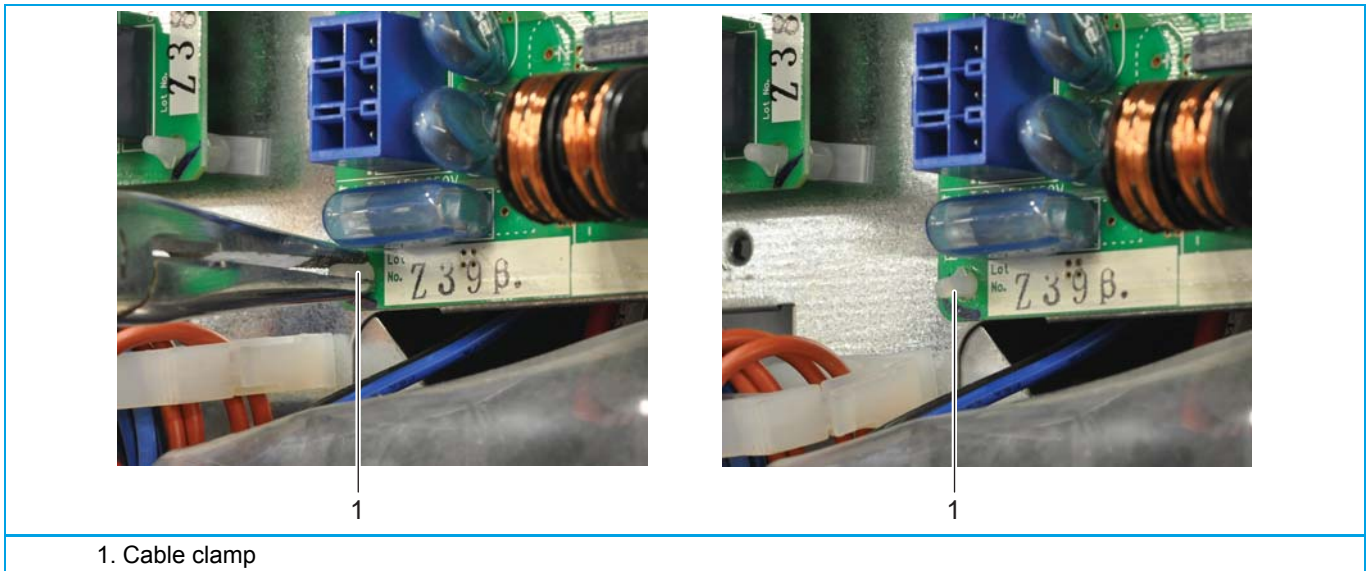

2.9. Displacing a bracket

1. Remove the screw (3) that fixes the bracket (1).
2. Slide the clamp (4) away from the insulation (2).

Figure 30 - Displacing a bracket

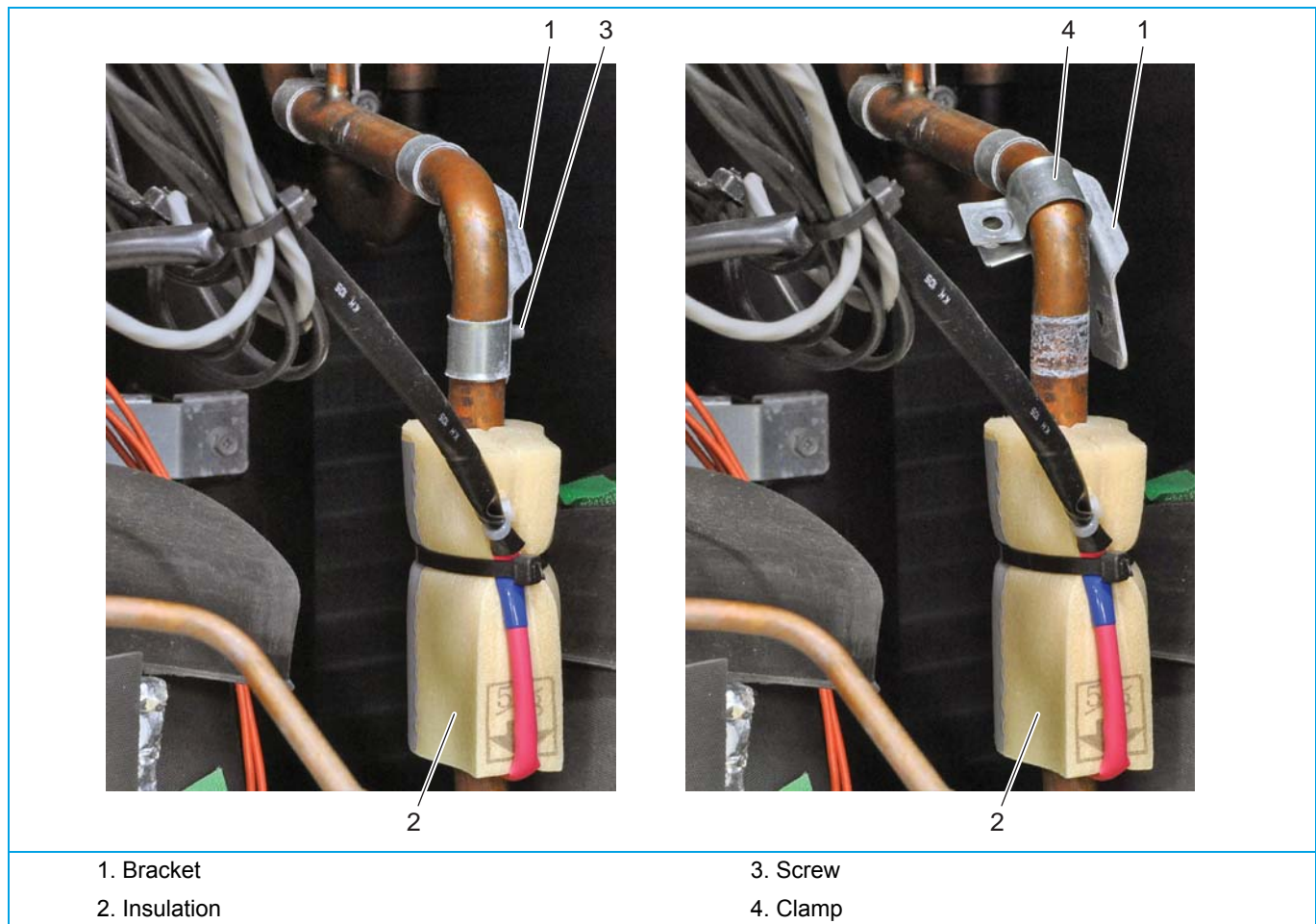

3. Parts replacement procedures

Overview of parts replacement procedures:

Replacing a PCB in the switch box.....	125	Replacing an expansion valve coil (Y2E, Y5E).....	162
Replacing a thermistor.....	145	Replacing an expansion valve	164
Replacing a pressure sensor (S1NPH, S1NPL).....	147	Replacing a fan propeller	167
Replacing a pressure switch (S1PH, S2PH).....	149	Replacing a fan motor.....	168
Replacing a 4 way valve coil (Y3S, Y4S, Y5S).....	150	Replacing a compressor	169
Replacing a solenoid valve coil (Y11S, Y12S).....	151	Replacing a crankcase heater E1HC, E2HC	174
Replacing a solenoid valve coil (Y2S)	152	Replacing a reactor (L1R, L2R) (REMQ5T7Y1B, REYQ8~12T7Y1B).....	175
Replacing a 4 way valve (Y3S~Y5S).....	153	Replacing a reactor (L1R, L2R, L3R) (REYQ14~20T7Y1B).....	177
Replacing a solenoid valve (Y11S, Y12S, Y2S).....	159	Replacing the fan assembly	179
Replacing an expansion valve coil (Y1E, Y3E, Y4E, Y6E).....	160	Replacing a control board in the BS unit.....	194

3.1. Replacing a PCB in the switch box

	<p>WARNING</p> <p>Electrical shock hazard. Remove power from the VRV4 Heat recovery system before removing the switch box cover. Do not touch terminals.</p>
-----------------------------------------------------------------------------------	---------------------------------------------------------------------------------------------------------------------------------------------------------------------

3.1.1. Procedure: replacing the A1 PCB (Main)

Preliminary actions

1. Switch off the VRV4 Heat recovery system with the field supplied circuit breaker.
2. Remove the front panel, refer to ["Removing the upper front plate assembly" on page 101](#).
3. Remove the switch box cover, refer to ["Removing the switch box cover" on page 103](#) (REMQ5T7Y1B, REYQ8~12T7Y1B) or ["Removing the switch box cover" on page 111](#) (REYQ14~20T7Y1B).

Removal

1. Unlatch the cable clamp at the top right corner of the A1P PCB (3) to facilitate its removal 3

Figure 31 - Cable clamp unlatching

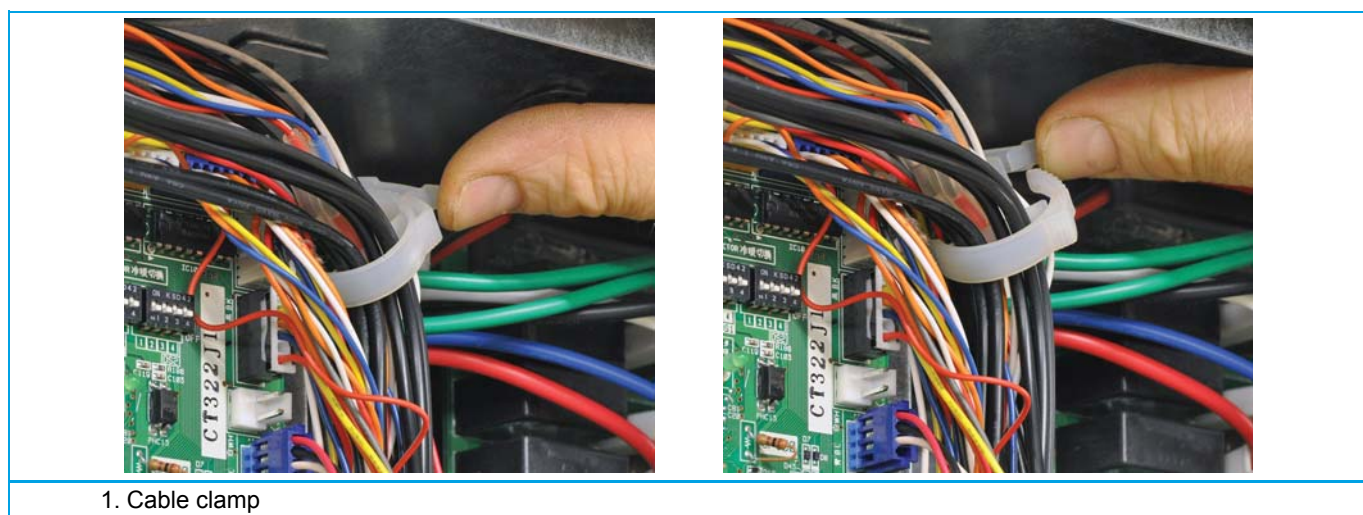

2. Unplug connectors X1A, X2A, X3A, X4A, X18A, X20A, X21A, X22A, X23A, X25A, X28A, X31A, X32A, X40A, X41A (1) from the A1P PCB (3).
3. Note the field wiring of X1M (2).
4. Loosen the screws from X1M (2) and remove the wiring.

- Carefully pull the A1P PCB (3) at the side and unlatch the 8 pcb supports (4) one by one using a small pliers, see §2.8.

Figure 32 - Replacing the A1P PCB (Main)

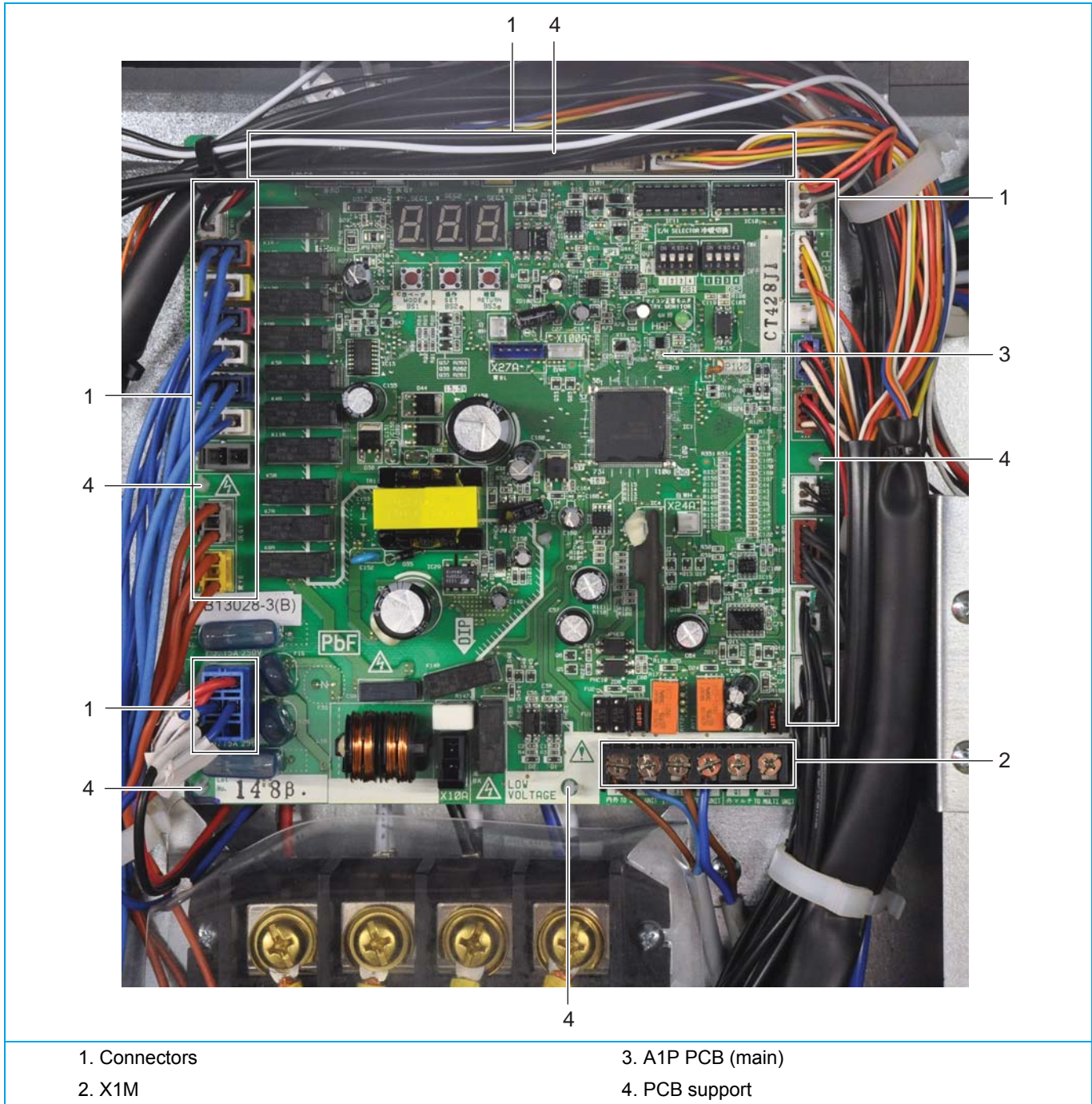

Installation

**INFORMATION**

When installing a new A1 PCB, install it as described in the installer notice supplied with the spare part.

1. Proceed in reverse order.
2. When reconnecting X40A (1) and X41A (2), observe proper connection/
 - the black/white wiring must be connected to X40A (1)
 - the red/black wiring must be connected to X41A (2),

Figure 33 - X40A/X41A wiring A1P PCB (Main)

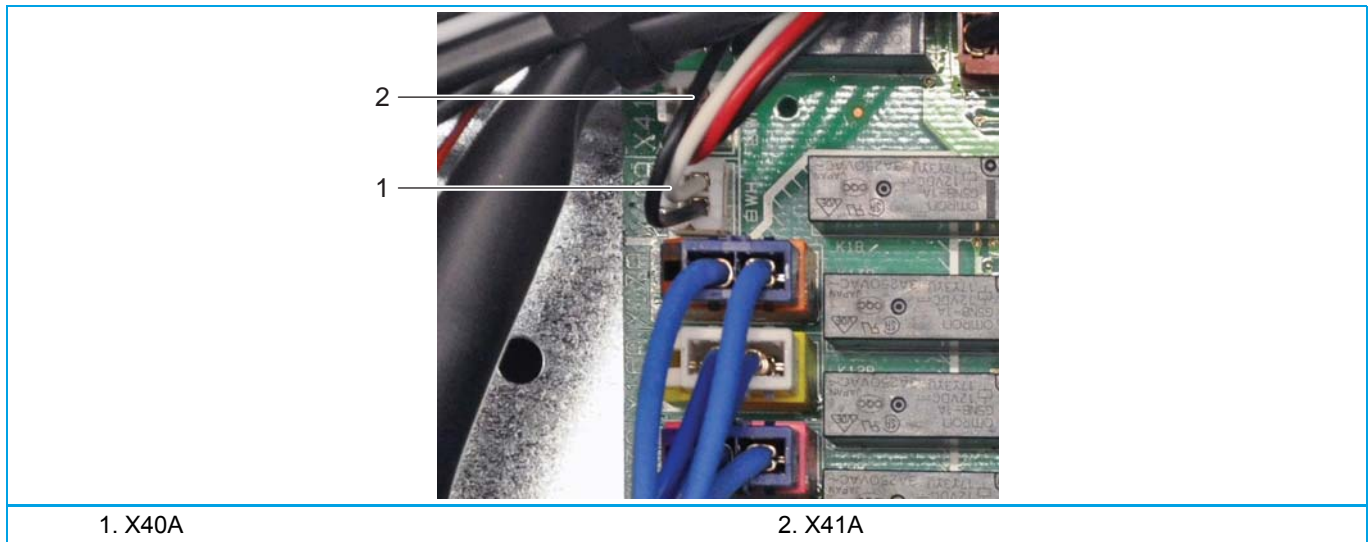

3.1.2. Procedure: replacing the A5P / A8P PCB (Sub)

Preliminary actions

1. Switch off the VRV4 Heat recovery system with the field supplied circuit breaker.
2. Remove the front panel, refer to "Removing the upper front plate assembly" on page 101.
3. Remove the switch box cover, refer to "Removing the switch box cover" on page 103 (REMQ5T7Y1B, REYQ8~12T7Y1B) or "Removing the switch box cover" on page 111 (REYQ14~20T7Y1B).



INFORMATION

The sub board is referenced as A5P (REMQ5T7Y1B, REYQ8~12T7Y1B) or A8P (REYQ14~20T7Y1B).

Removal

1. Unplug connectors X1A, X2A, X3A, X8A, X10A, X15A and X17A (1) from the A5P / A8P PCB (Sub) (2).
2. Carefully pull the A5P / A8P PCB (2) at the side and unlatch the 6 pcb supports (3) one by one using a small pliers, see §2.8.

Figure 34 - Replacing the A5P / A8P PCB (Sub)

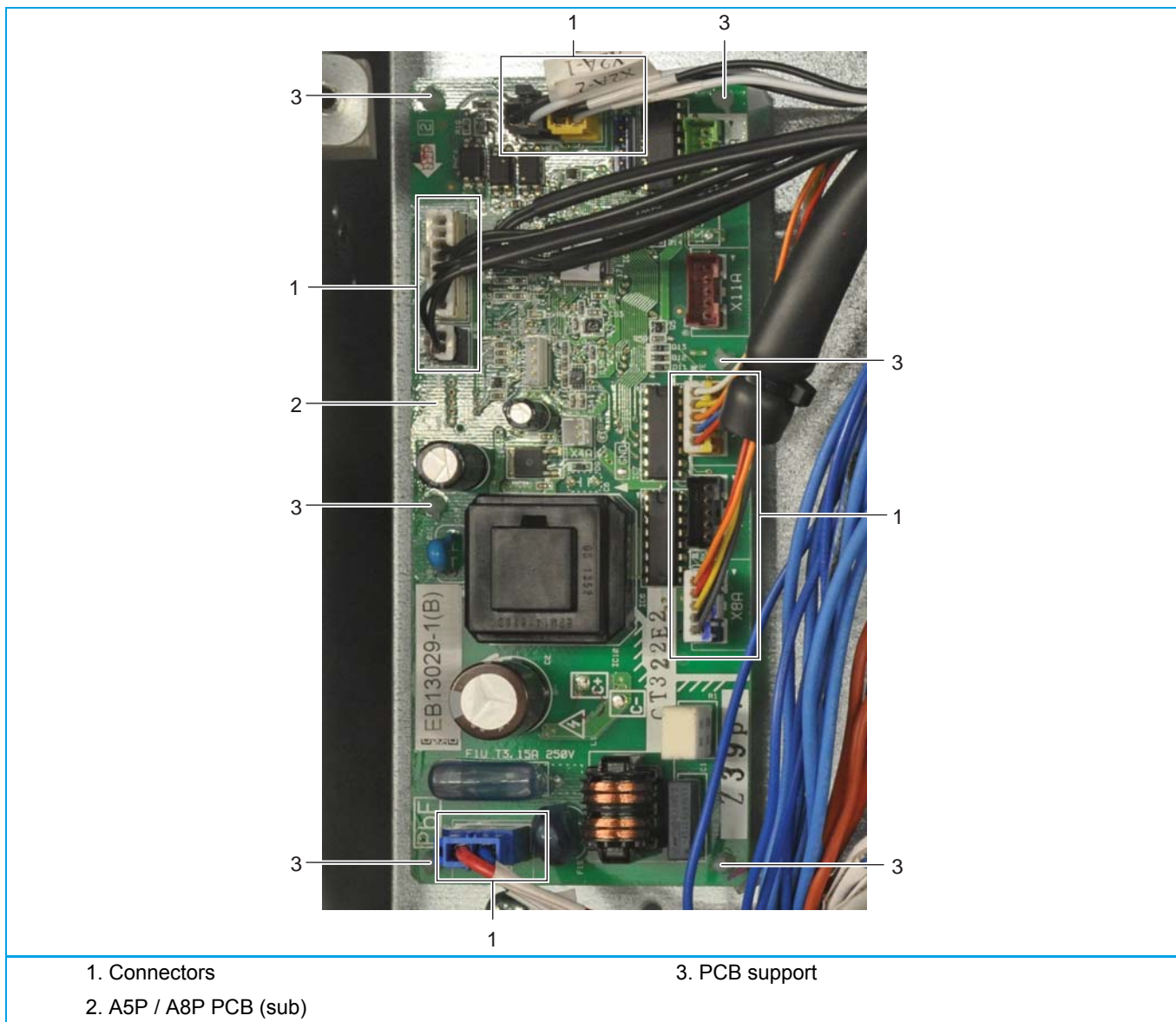

Installation

1. Proceed in reverse order.

3.1.3. Replacing the noise filter board A2P / A5P (Noise filter)

**WARNING**

Electrical shock hazard. Remove power from the VRV4 Heat recovery system before removing the switch box cover.
Do not touch terminals.

Preliminary actions

1. Switch off the VRV4 Heat recovery system with the field supplied circuit breaker.
2. Remove the front panel, refer to ["Removing the upper front plate assembly" on page 101](#).
3. Remove the switch box cover, refer to ["Removing the switch box cover" on page 103](#) (REMQ5T7Y1B, REYQ8~12T7Y1B) or ["Removing the switch box cover" on page 111](#) (REYQ14~20T7Y1B).
4. Tilt the inverter mounting plate, refer to ["Tilting the inverter mounting plate \(REYQ14~20T7Y1B\)" on page 118](#).

Removal**INFORMATION**

The power terminals of the noise filter for the J-type compressor (type 2) has screw connections in stead of Faston plugs.

1. Unplug the Faston plugs (or loosen and remove screw connectors) power in L1A, L2A, L3A, NA, E (1).
2. Unplug X402A (2) (not for J-type compressor).
3. Unplug X403A (3).
4. Unplug the Faston plugs (or loosen and remove screw connectors) power out L1B, L2B, L3B (4).
5. Carefully pull the A2P / A5P PCB (5) at the side and unlatch the 6 pcb supports (6) one by one using a small pliers, [see §2.8](#).

Figure 35 - Replacing the A2P / A5P PCB (Noise filter)

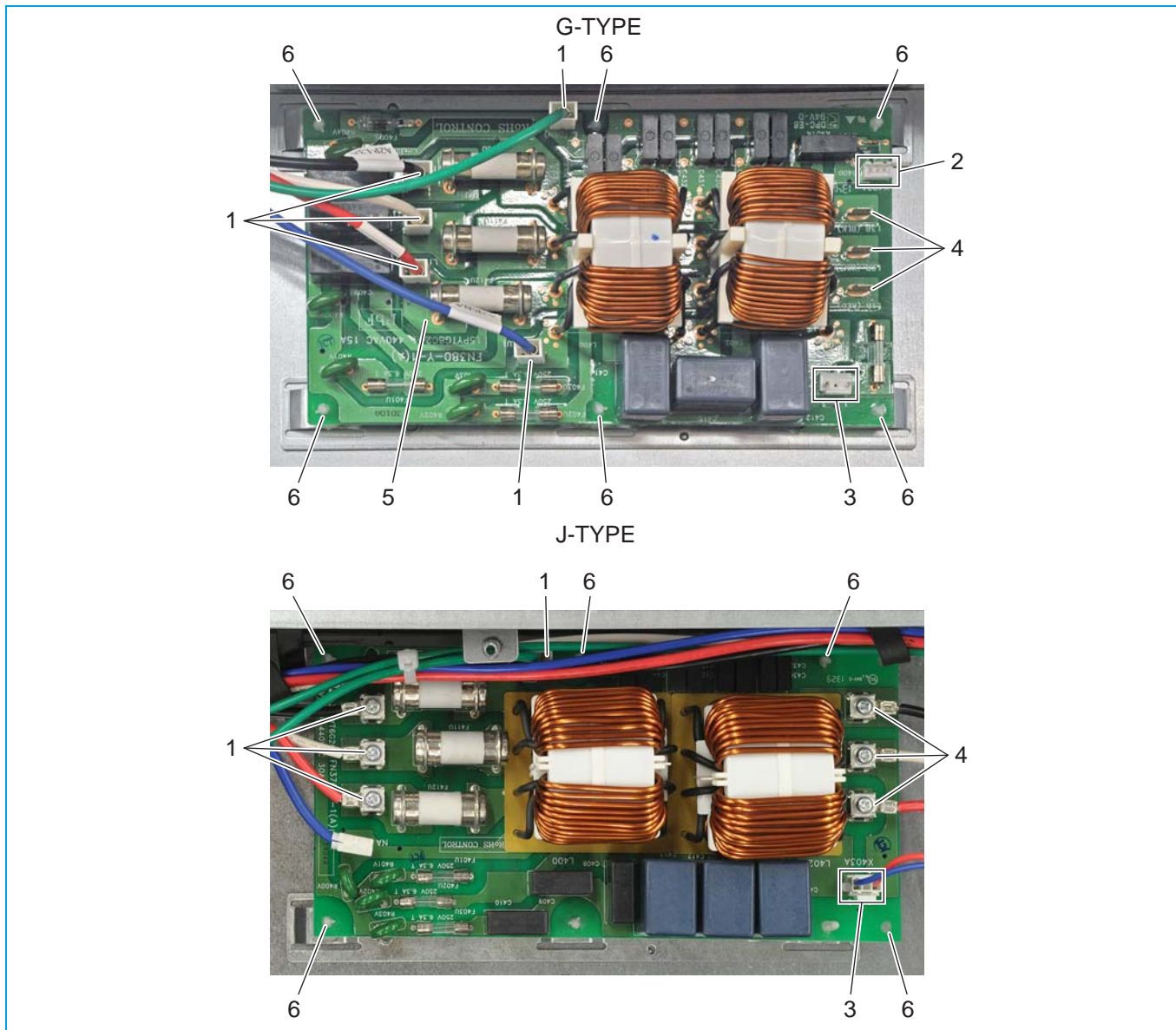

- | | |
|-------------------------|------------------|
| 1. L1A, L2A, L3A, NA, E | 4. L1B, L2B, L3B |
| 2. X402A | 5. A2P / A5P PCB |
| 3. X403A | 6. PCB support |

Installation



CAUTION

Make sure to reconnect L1A, L2A, L3A, NA, E, L1B, L2B, L3B at the correct position.

1. Proceed in reverse order.

3.1.4. Replacing the compressor inverter board A3P (REMQ5T7Y1B, REYQ8~12T7Y1B)



WARNING

Electrical shock hazard. Remove power from the VRV4 Heat recovery system before removing the switch box cover. Do not touch terminals.

Preliminary actions

1. Switch off the VRV4 Heat recovery system with the field supplied circuit breaker.
2. Remove the upper front plate assembly, refer to "Removing the upper front plate assembly" on page 101.
3. Remove the front plate assembly, refer to "Removing the front plate assembly" on page 102.
4. Remove the switch box cover, refer to "Removing the switch box cover" on page 103.

Removal

1. Loosen and remove the screws (1) that fix the power terminal assembly (2).
2. Loosen and remove the 2 screws (3) that fix the cable clamps (4).
3. Unplug the fan connectors X1A, X2A (5).
4. Unplug the wiring (6) from the main board.
5. Detach the tie wrap (7).
6. Unplug the wiring (8) from the main board and sub board.

Figure 36 - Removing the compressor inverter board A3P - 1

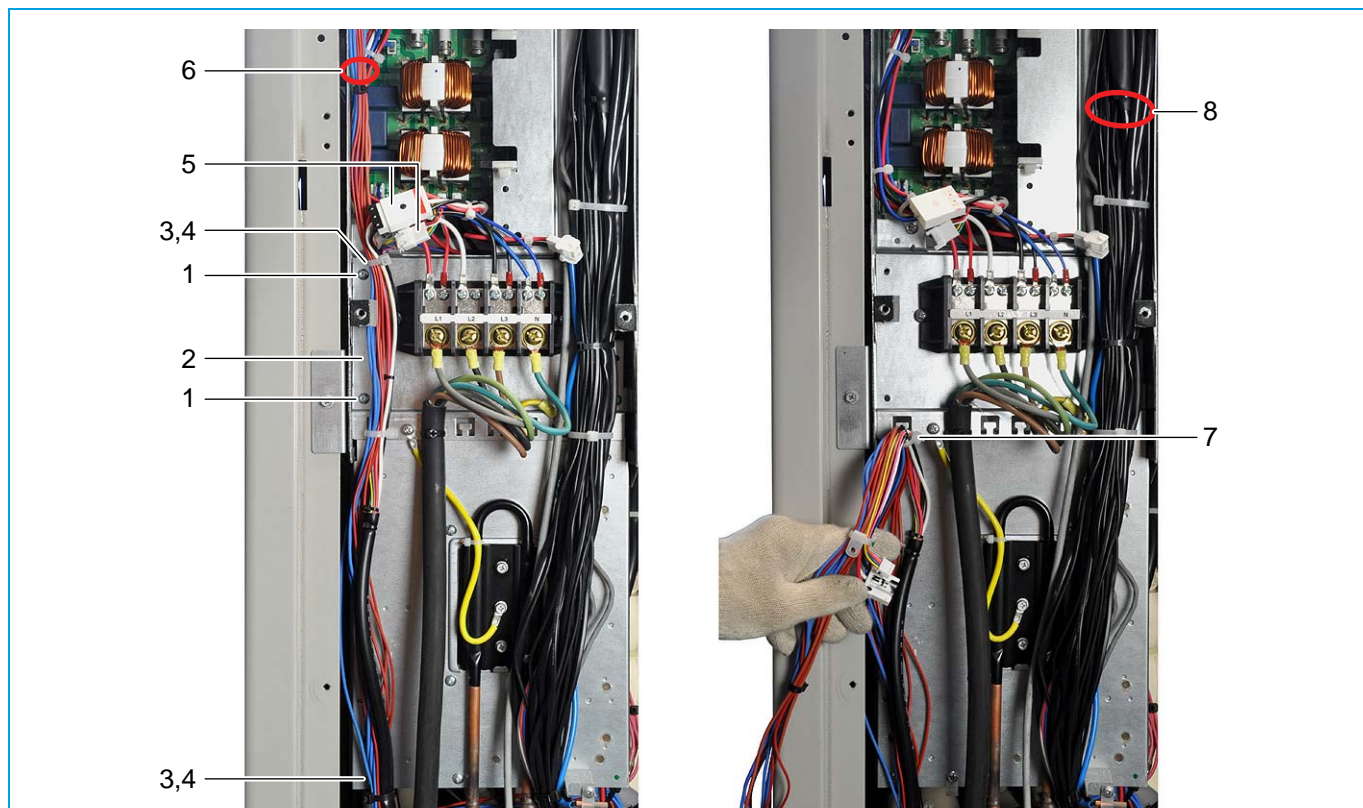

1. Screw
2. Power terminal assembly
3. Screw
4. Cable clamp

5. X1A, X2A
6. Wiring
7. Tie wrap
8. Wiring

7. Loosen and remove the screw (1) that fixes the cable clamp (2).
8. Detach the tie wrap (3).
9. Cut the tie wraps (4) on the cable harness,
10. Separate the cables (5) and (6).
11. Loosen and remove the 2 screws (7) that fix the compressor inverter assembly(12).
12. Loosen and remove the screw (8) that fixes the thermistor clamp (9).
13. Loosen and remove the 2 screws (10) that fix the heat pipe (11).
14. Loosen and remove the screw (13) that fixes the ground wire (14).

Figure 37 - Removing the compressor inverter board A3P - 2

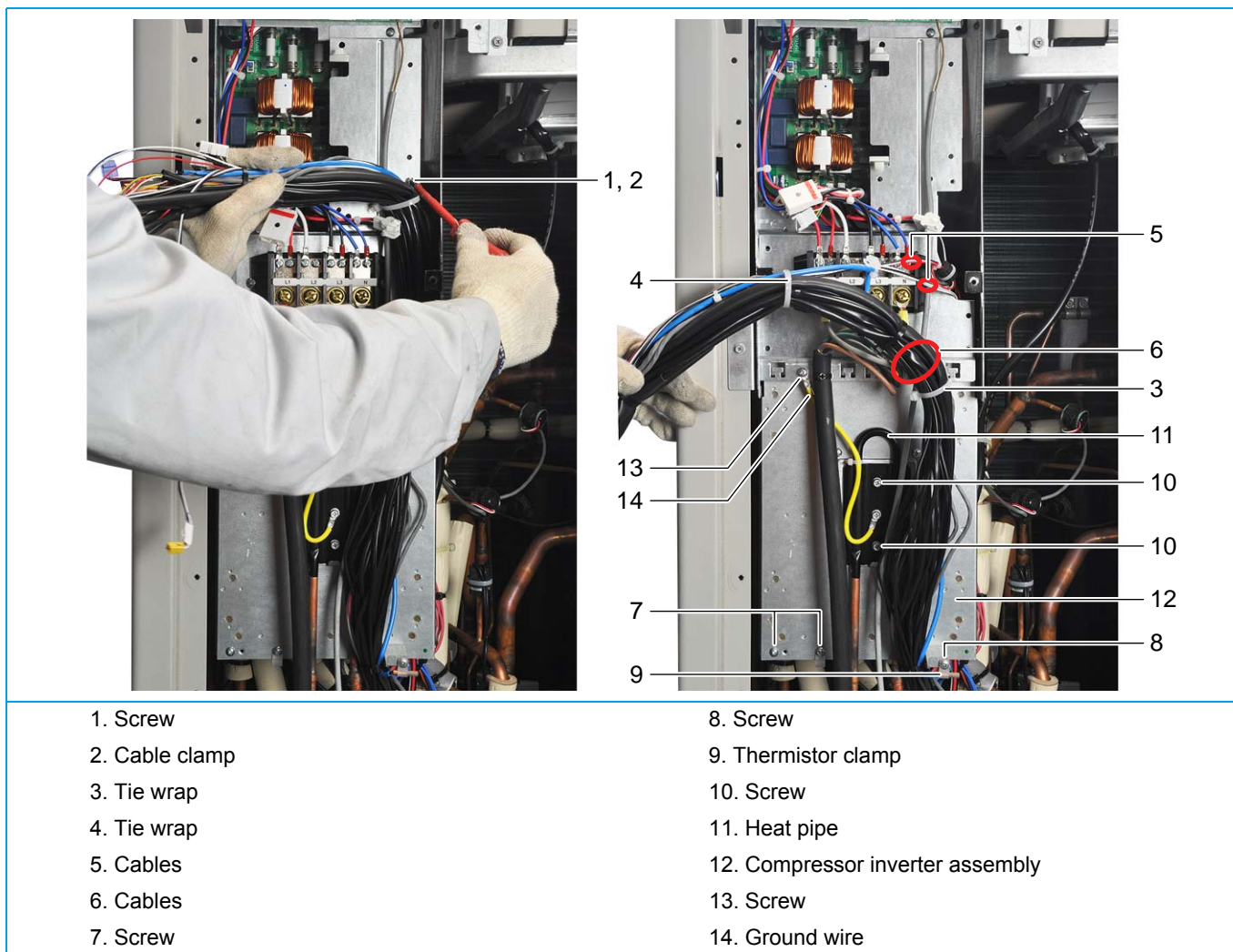

15. Using a flat screwdriver (1), separate the heat pipe (2) and the heat sink (3).
16. Loosen and remove the screw (4) that fixes the power terminal assembly (5).
17. Move the power terminal assembly (5) to the right.
18. Disconnect connectors X3 (7) and X5 (8) from the fan inverter board (9).

Figure 38 - Removing the compressor inverter board A3P PCB - 3

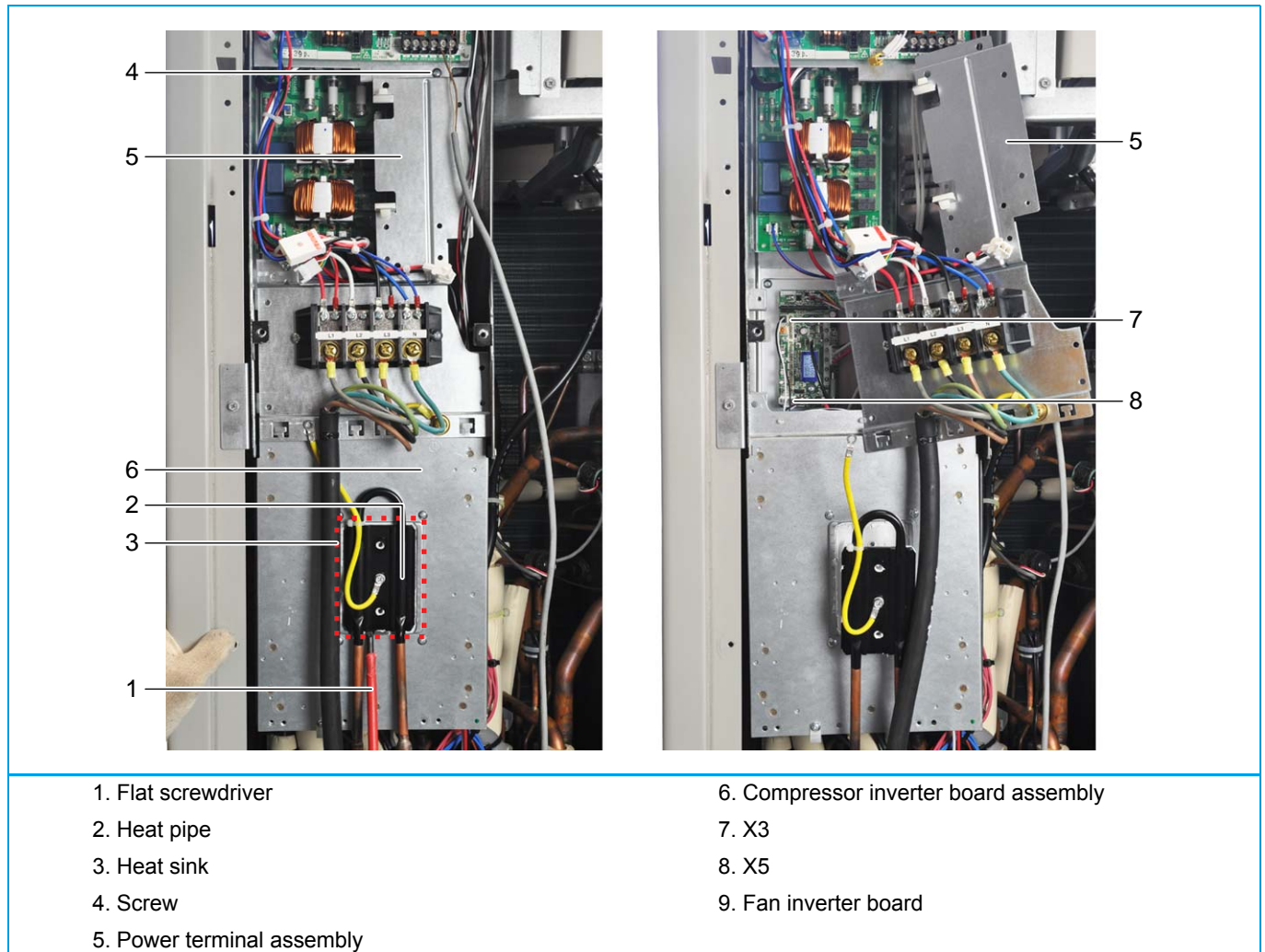

19. Turn the power terminal assembly (1) to the left.
20. Remove the 4 screws (4) that fix the heat sink (5).
21. Lift and slightly tilt the compressor inverter board assembly (2), guide the compressor cable (3) into the switch box.
22. Put the compressor inverter board assembly (2) in horizontal position.



INFORMATION

The power terminals of the inverter board for the J-type compressor has screw connections in stead of Faston plugs.

23. Disconnect all wiring from the compressor board.
24. Remove the 4 screws (6) that fix the compressor inverter board.
25. Remove the compressor inverter board.

Figure 39 - Removing the compressor inverter board A3P PCB - 4

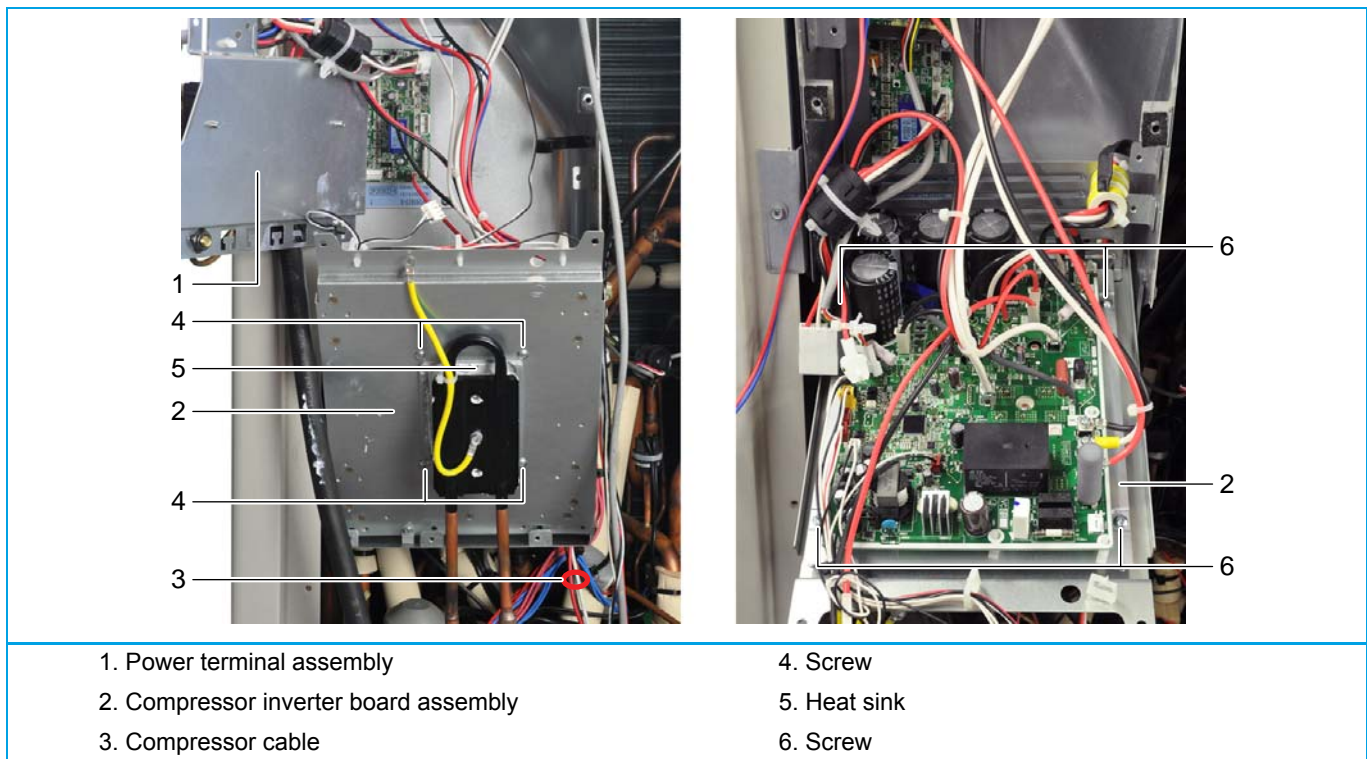

Installation



INFORMATION

Replace all tie wraps that were cut during removal.
 Reattach the detached tie wraps.
 Reinstall all cable clamps
 Secure the cables using the cable clamps.

1. Clean the heat sink surface.
2. Apply a thin layer of heat sink compound to the heat sink surface.
3. Proceed in reverse order

3.1.5. Replacing the compressor inverter board A3P (type 1 (G) compressor) (REYQ14~20T7Y1B)

**WARNING**

Electrical shock hazard. Remove power from the VRV4 Heat recovery system before removing the switch box cover.
Do not touch terminals.

Preliminary actions

1. Switch off the VRV4 Heat recovery system with the field supplied circuit breaker.
2. Remove the front panel, refer to "[Removing the upper front plate assembly](#)" on page 101.
3. Remove the switch box cover, "[Removing the switch box cover](#)" on page 111.
4. Tilt the inverter mounting plate, refer to "[Tilting the inverter mounting plate \(REYQ14~20T7Y1B\)](#)" on page 118.
5. Remove the switch box from the VRV4, refer to "[Removing the inverter mounting plate \(REYQ14~20T7Y1B\)](#)" on page 120.

Removal

1. Unplug Faston plugs L1B, L2B, L3B (1).
2. Unplug Faston plugs in P1, P2 (2).
3. Unplug Faston plugs in U,V,W (3).
4. Unplug N3 (4).
5. Unplug P3 (5).
6. Unplug X63A (6).
7. Unplug X1A (7).
8. Unplug X61A (8).
9. Unplug X6A (9).
10. Unplug X62A (10).
11. Unplug X4A(11).
12. Unplug X41A(12).
13. Remove the 4 screws (13).

Figure 40 - Removing the wiring from the A3P PCB (Inv type 1)

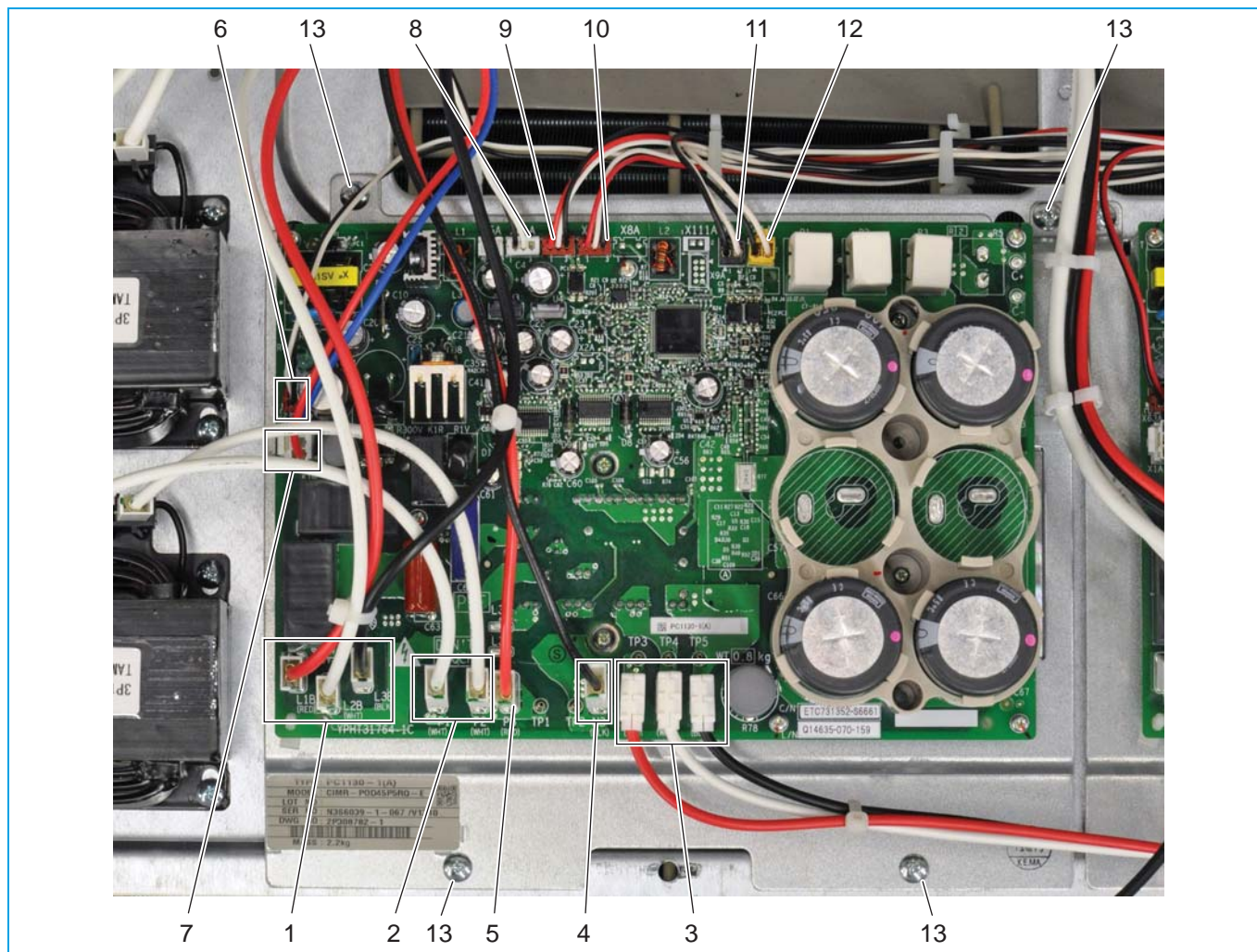

- | | |
|------------------|-----------|
| 1. L1B, L2B, L3B | 8. X61A |
| 2. P1, P2 | 9. X6A |
| 3. U, V, W | 10. X62A |
| 4. N3 | 11. X4A |
| 5. P3 | 12. X41A |
| 6. X63A | 13. Screw |
| 7. X1A | |

14. Remove the 4 screws (1) that fix the heat sink (2) to the switch box.

Figure 41 - Removing the A3P PCB (Inv type 1)

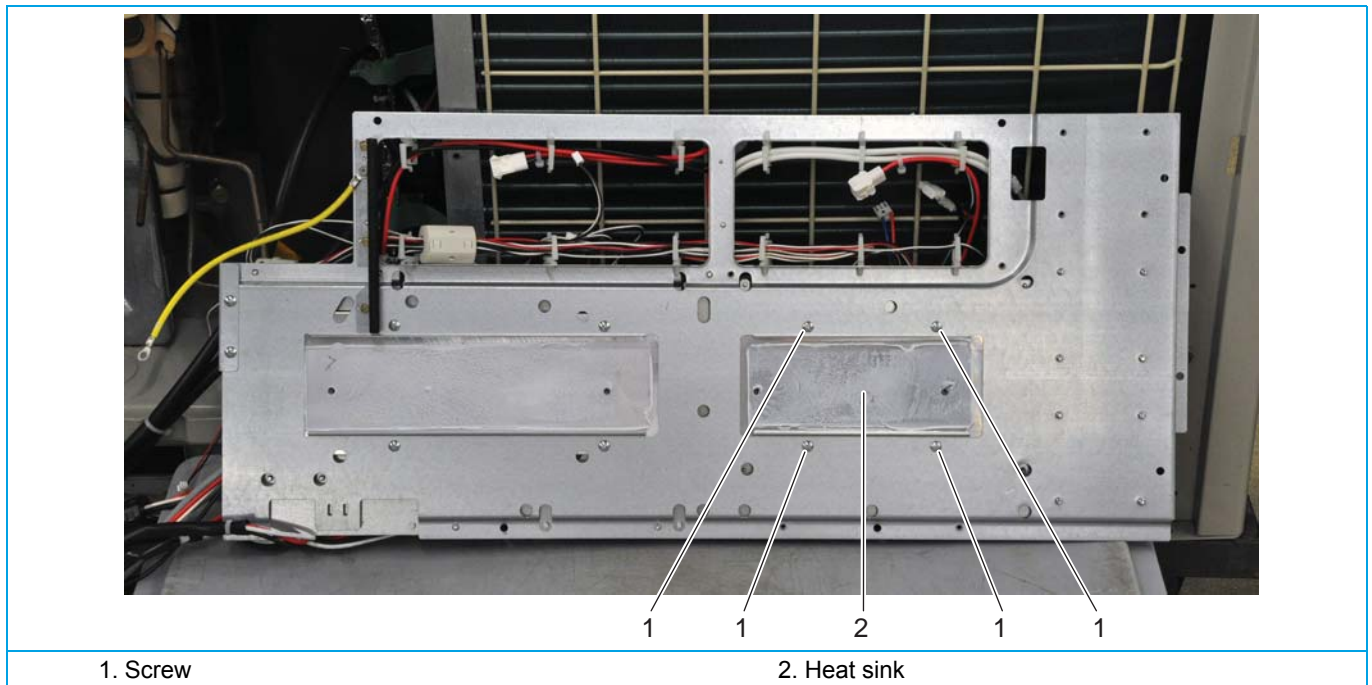

15. Remove the A3P PCB.

Installation



INFORMATION

Replace all tie wraps that were cut during removal.

1. Proceed in reverse order
2. After reinstalling the switch box in the VRV4, clean the heat sink surface.
3. Apply a thin layer of heat sink compound to the heat sink surface.

3.1.6. Replacing the compressor inverter board A6P (type 2 (J) compressor) (REYQ14~20T7Y1B)



WARNING

Electrical shock hazard. Remove power from the VRV4 Heat recovery system before removing the switch box cover.
Do not touch terminals.

Preliminary actions (REYQ14~20T7Y1B)

1. Switch off the VRV4 Heat recovery system with the field supplied circuit breaker.
2. Remove the front panel, refer to "[Removing the front plate assembly](#)" on page 110.
3. Remove the switch box cover, refer to "[Removing the switch box cover](#)" on page 111.
4. Tilt the inverter mounting plate, refer to "[Tilting the inverter mounting plate \(REYQ14~20T7Y1B\)](#)" on page 118.
5. Remove the switch box from the VRV4, refer to "[Removing the inverter mounting plate \(REYQ14~20T7Y1B\)](#)" on page 120.

Removal

1. Loosen and remove screw connectors in L1B, L2B, L3B (1).
2. Loosen and remove screw connectors in P11, P21 (2).
3. Loosen and remove screw connectors in U,V,W (3).
4. Unplug N4, N5 (4).
5. Unplug P4, P5 (5).
6. Unplug X63A (6).
7. Unplug X601A (7).
8. Unplug X6A (8).
9. Unplug X41A (9).
10. Unplug X4A (10).
11. Unplug X602A (11).



INFORMATION

The wiring does not have to be removed from the fan inverter boards; removing the PCBs with the wiring still connected.

12. Remove the fan inverter boards (12,13) ([see §3.1.7](#)).
13. Remove the 6 screws (14) that fix the inverter assembly.

Figure 42 - Removing the wiring from the A6P PCB (Inv type 2)

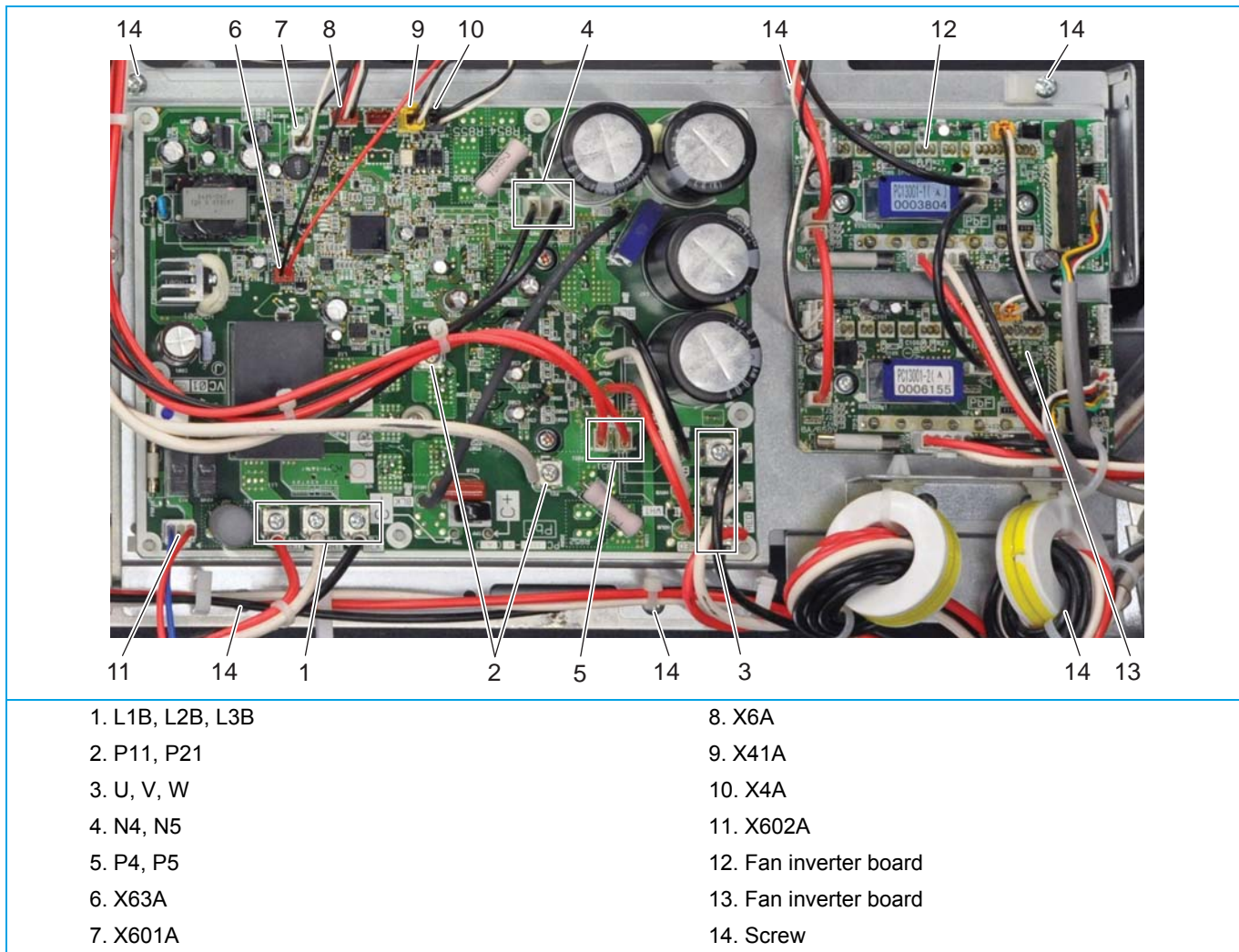

14. Remove the 4 screws (1) that fix the heat sink (2) to the switch box.
15. Remove the A6P PCB.

Figure 43 - Removing the A6P PCB (Inv type 2)

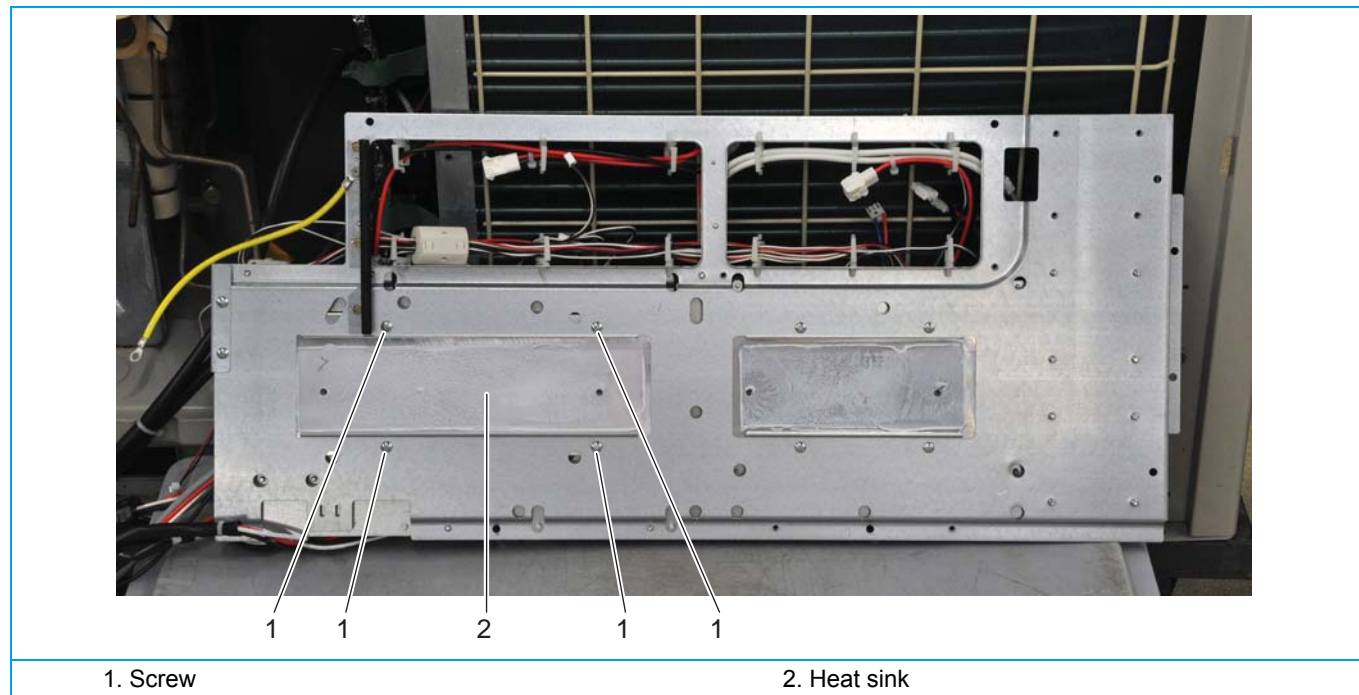

Installation





INFORMATION

Replace all tie wraps that were cut during removal.

1. After reinstalling the switch box in the VRV4, clean the heat sink surface.
2. Apply a thin layer of heat sink compound to the heat sink surface.

3.1.7. Replacing a fan inverter board A4P (REMQ5T7Y1B, REYQ8~12T7Y1B)

	<p>WARNING</p> <p>Electrical shock hazard. Remove power from the VRV4 Heat recovery system before removing the switch box cover. Do not touch terminals.</p>
-----------------------------------------------------------------------------------	---------------------------------------------------------------------------------------------------------------------------------------------------------------------

	<p>CAUTION</p> <p>The A4P and A8P boards are not interchangeable.</p>
-----------------------------------------------------------------------------------	------------------------------------------------------------------------------



Preliminary actions

1. Switch off the VRV4 Heat recovery system with the field supplied circuit breaker.
2. Remove the front panel, refer to "Removing the upper front plate assembly" on page 101.
3. Remove the switch box cover, refer to "Removing the switch box cover" on page 103.
4. Tilt the main and sub board assembly and the power terminal assembly, refer to "Tilting the main and sub board assembly and the power terminal assembly (REMQ5T7Y1B, REYQ8~12T7Y1B)" on page 122.

Removal

1. Using a pliers, detach the cable clamp (1) from the power terminal assembly.
2. Unplug the fan connectors X1A (2), X2A (3).
3. Unplug the connectors X1A (4), X2A (5) from the fan inverter board (6).

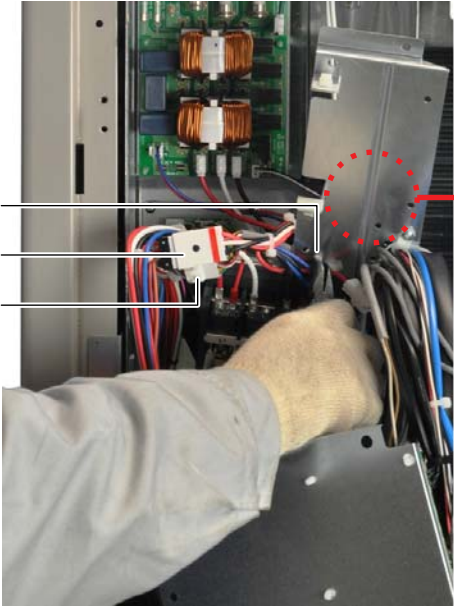
Figure 44 - Replacing a fan inverter board (REMQ5T7Y1B, REYQ8~12T7Y1B)

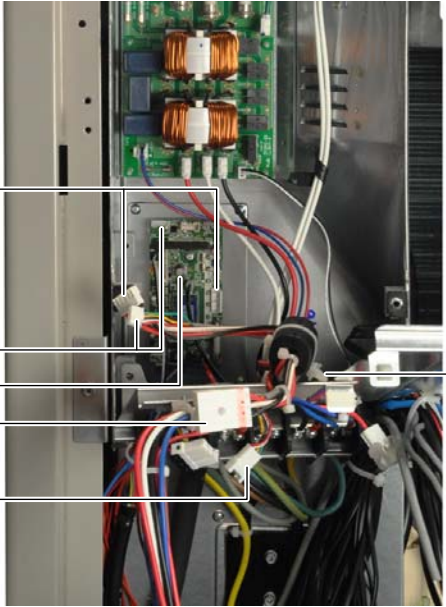
		
<ol style="list-style-type: none"> 1. Cable clamp 2. X1A (fan wiring) 3. X2A (fan wiring) 		<ol style="list-style-type: none"> 4. X1A (PCB) 5. X2A (PCB) 6. Inverter board

4. Unplug connector X3A (1).
5. Unplug jumper X4A (2).
6. Unplug connectors X5A (3).

7. Unplug Faston plug N1 (4).
8. Unplug Faston plug P1 (5).



INFORMATION

The fan inverter board, including heat sink and mounting plate are replaced.

9. Loosen and remove the 4 screws (7) that fix the fan inverter board A4P assembly (6).

Figure 45 - Replacing the fan inverter board assembly A4P

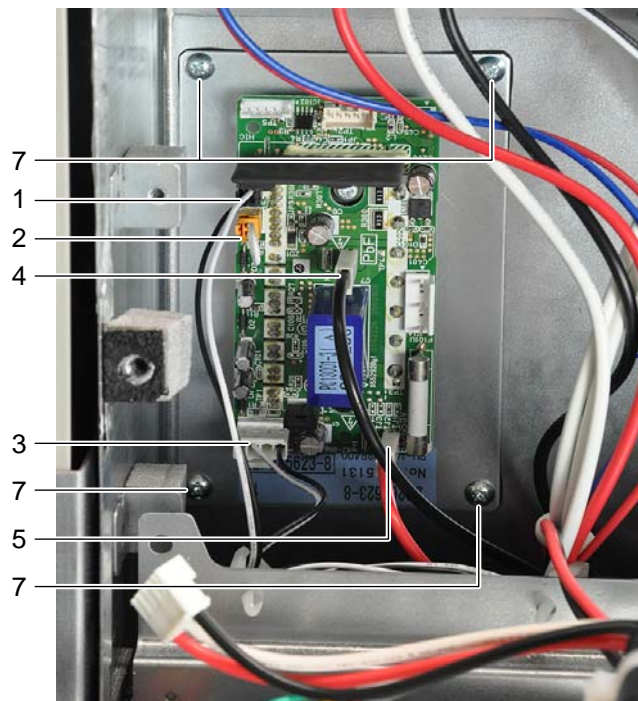

1. X3A
2. X4A
3. X5A
4. N1

5. P1
6. Fan inverter board A4P assembly
7. Screw

Installation

1. Proceed in reverse order.

3.1.8. Replacing a fan inverter board A4P / A8P (REYQ14~20T7Y1B)

**WARNING**

Electrical shock hazard. Remove power from the VRV4 Heat recovery system before removing the switch box cover.
Do not touch terminals.

**CAUTION**

The A4P and A8P boards are not interchangeable.

Preliminary actions

1. Switch off the VRV4 Heat recovery system with the field supplied circuit breaker.
2. Remove the front panel, refer to "[Removing the upper front plate assembly](#)" on page 101.
3. Remove the switch box cover, or "[Removing the switch box cover](#)" on page 111.
4. Tilt the inverter mounting plate, refer to "[Tilting the inverter mounting plate \(REYQ14~20T7Y1B\)](#)" on page 118.
5. Remove the inverter mounting plate from the VRV4, refer to "[Removing the inverter mounting plate \(REYQ14~20T7Y1B\)](#)" on page 120.

Removal

1. Unplug connectors X1A (1).
2. Unplug connectors X2A (2).
3. Unplug connectors X3A (3).
4. Unplug connectors X4A (4) (= jumper on A4P).
5. Unplug connectors X5A (5).
6. Unplug Faston plug N1 (6) (A7 PCB only).
7. Unplug Faston plug P1 (7) (A7 PCB only).
8. Unplug Faston plug N11 (9).
9. Unplug Faston plug P11 (8).
10. Loosen and remove the 2 screws (12) that fix the fan inverter board A4P (10) / A8P (11).

Figure 46 - Replacing the A4P / A8P PCB

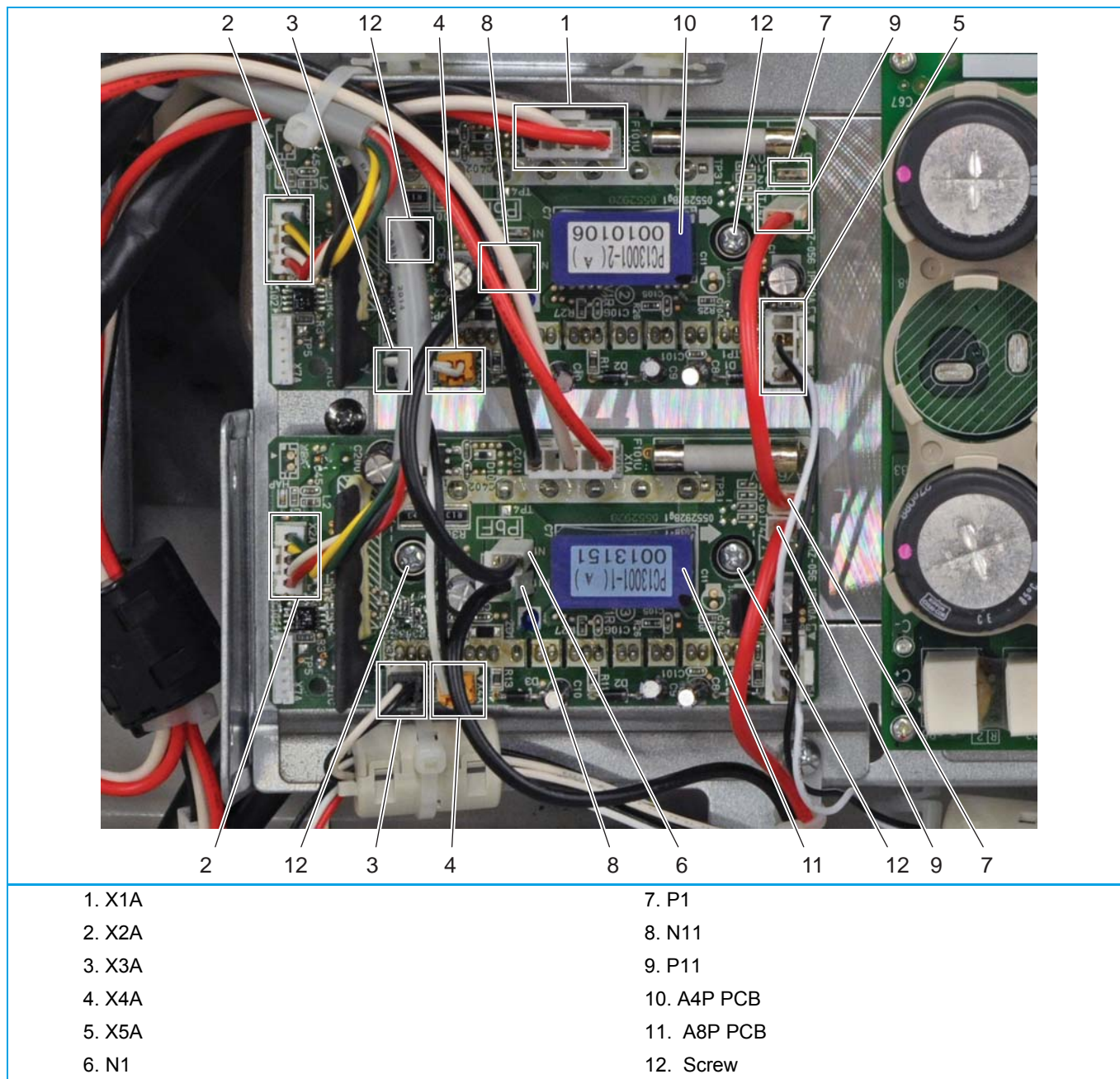

Installation

1. Proceed in reverse order.

3.2. Replacing a thermistor

Preliminary actions

1. Remove the front panel, refer to ["Removing the upper front plate assembly" on page 101](#).
2. Remove the switch box cover, refer to ["Removing the switch box cover" on page 103](#) (REMQ5T7Y1B, REYQ8~12T7Y1B) or ["Removing the switch box cover" on page 111](#) (REYQ14~20T7Y1B).
3. For some thermistors, it may be required to displace a bracket before the insulation can be moved away, ["Displacing a bracket" on page 124](#).

Procedure

The position of all thermistors is illustrated in ["Piping overview REMQ5T7Y1B, REYQ8~REYQ12T7Y1B" on page 226](#) and ["Piping overview REYQ14~REYQ20T7Y1B - part 2" on page 228](#)

Table 3-21: Thermistors wiring overview

Thermistor	Processed by PCB	Connector	Access Information
R1T (Air)	A1P	X181	No insulation on thermistor.
R21T, R22T (M1C, M2C, Discharge)	A1P	X19A	Must be removed together with R15T.
R15T (Compressor Body)	A8P		Remove compressor insulation, also remove R21T, R22T.
R3T (Liq. Main)	A1P	X30A	R4T, R5T, R6T, R7T must be removed together.
R4T(Heat Exc. Liq. Upper)	A1P		
R5T(Heat Exc. Liq. Lower)	A1P		
R6T (Subcool Heat exc. Gas)	A1P		
R7T (Subcool Heat exc. Liq)	A1P		
R8T (Heat Exc. Gas Upper)	A1P	X29A	R8T, R9T, R10T must be removed together.
R9T (Heat Exc. Gas Lower)	A1P		
R10T (Suction)	A1P		
R11T (Heat Exc. Deicer)	A8P	X15A	R10T, R12T, R13T must be removed together.
R12T (Suction Compressor)	A8P		
R14T (Auto Charge)	A8P		
R13T (Receiver Gas)	A8P	X17A	-

Removal



INFORMATION

If a bracket obstructs the insulation displacement, it must be removed.

The procedure below describes the replacement of a single thermistor.

1. Cut the tie wrap (1) that fixes the insulation (3) and the thermistor wire (2).
2. Slide the insulation (3) aside.
3. Press the clip (5) that fixes the sensor (6) in the sensor holder (4).
4. Remove the sensor (6) from the sensor holder (4).
5. If applicable, remove the other sensors that are wired to the same connector, refer to [Table 3-21 on page 145](#).
6. Cut all tie wraps that fix the thermistor wiring.
7. Unplug the appropriate connector, refer to [Table 3-21 on page 145](#).

Figure 47 - Replacing a thermistor

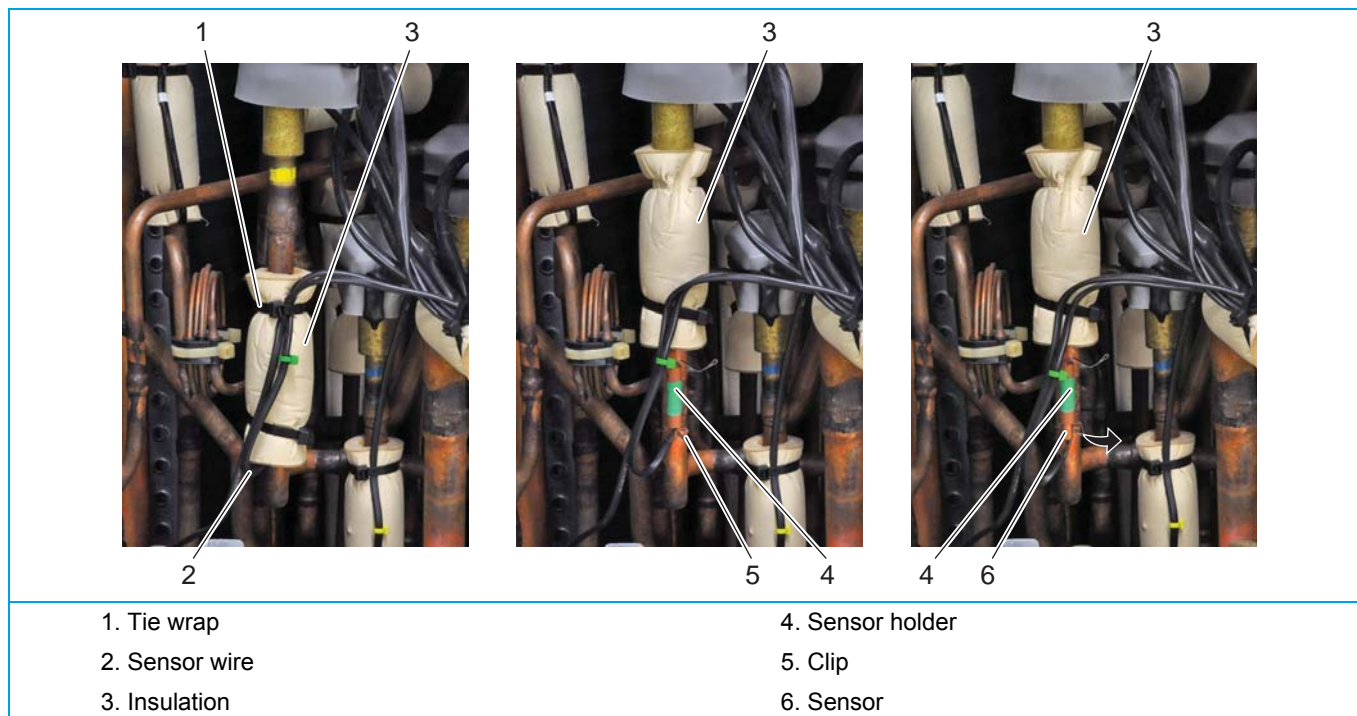

Installation



INFORMATION

Relocate all insulation that was displaced during removal of the thermistor.
Replace all tie wraps that were cut during removal.

1. Proceed in reverse order.

3.3. Replacing a pressure sensor (S1NPH, S1NPL)

Preliminary actions

1. Remove the front panel, refer to "Removing the upper front plate assembly" on page 101.
2. Remove the switch box cover, refer to "Removing the switch box cover" on page 103 (REM5T7Y1B, REYQ8~12T7Y1B) or "Removing the switch box cover" on page 111 (REYQ14~20T7Y1B).
3. Recover the refrigerant, refer to "Refrigerant Handling" on page 95.

Procedure

The removal of a pressure sensor is illustrated in "Removing a pressure sensor (S1NPH, S1NPL) (1)" on page 147.

1. Connect a nitrogen hose (2) to the outdoor suction service port (1) (middle service port).
2. Attach a hose with core-depressor (4) to allow the release of the nitrogen.
 - If Y4S or Y5S is in the off condition (outdoor upper respectively middle heat-exchanger is condenser), attach a hose (4) to the outdoor liquid service port (3) (left service port).
 - If Y4S and Y5S are in the on condition (outdoor upper and middle heat-exchanger are evaporator), attach a hose (4) to the HP/LP service port (8) (right service port).
3. Using a pipe cutter (5), cut the pressure sensor pipe (7).
4. Cut all tie wraps that fix the pressure sensor (6) wiring.
5. Unplug the appropriate connector, refer to "Wiring diagrams" on page 215.

Figure 48 - Removing a pressure sensor (S1NPH, S1NPL) (1)

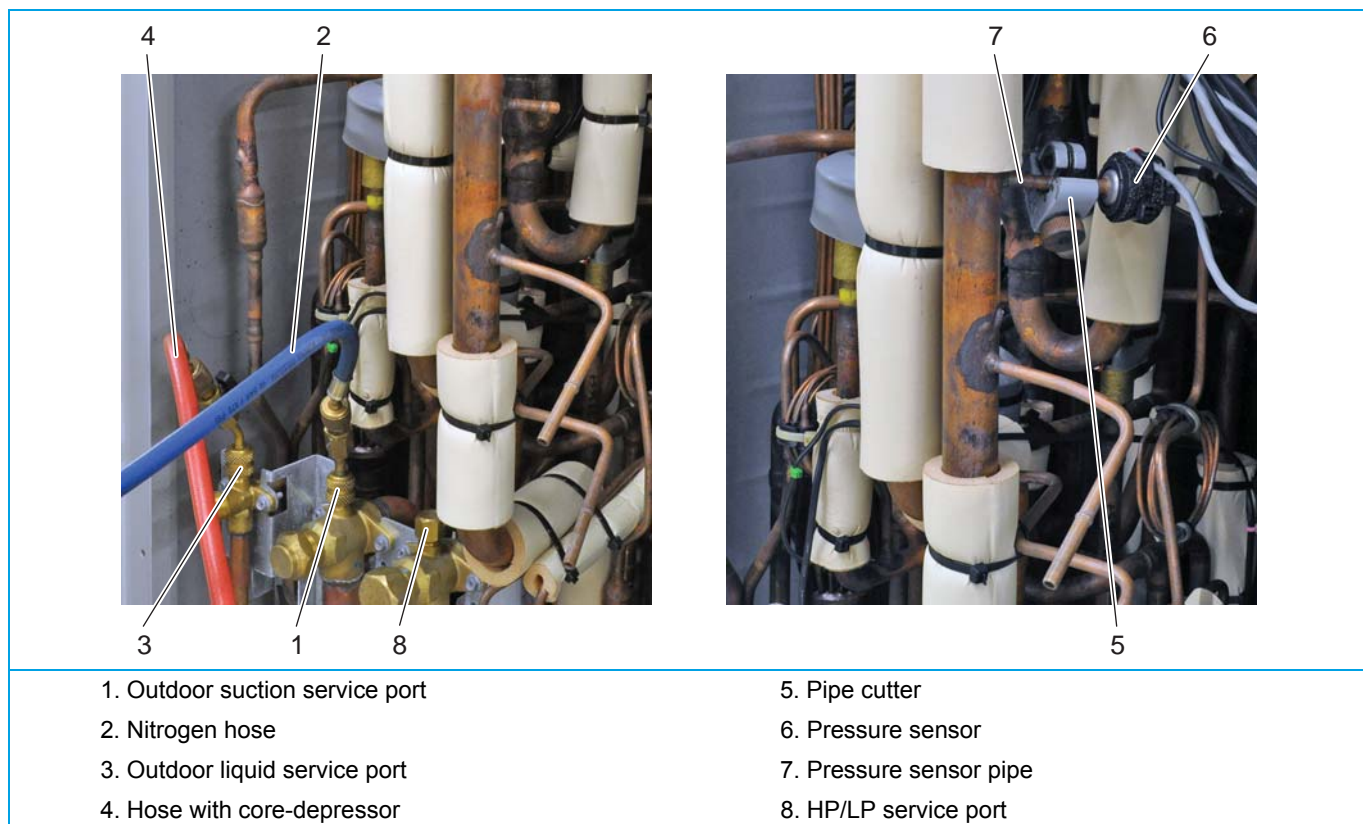

6. Remove the insulation (1) surrounding the pressure sensor pipe (3).
7. Put aside the electrical wiring in the neighbourhood of the pressure sensor pipe (3).

**CAUTION**

The maximum applied Nitrogen pressure must not exceed 0.02 MPa.

8. Supply nitrogen to the piping circuit.
9. Heat the pressure sensor pipe (3) using an oxygen acetylene torch (2), remove the pressure sensor pipe (3).
10. Cut the nitrogen supply when the piping has cooled down.

Figure 49 - Removing a pressure sensor (S1NPH, S1NPL) (2)

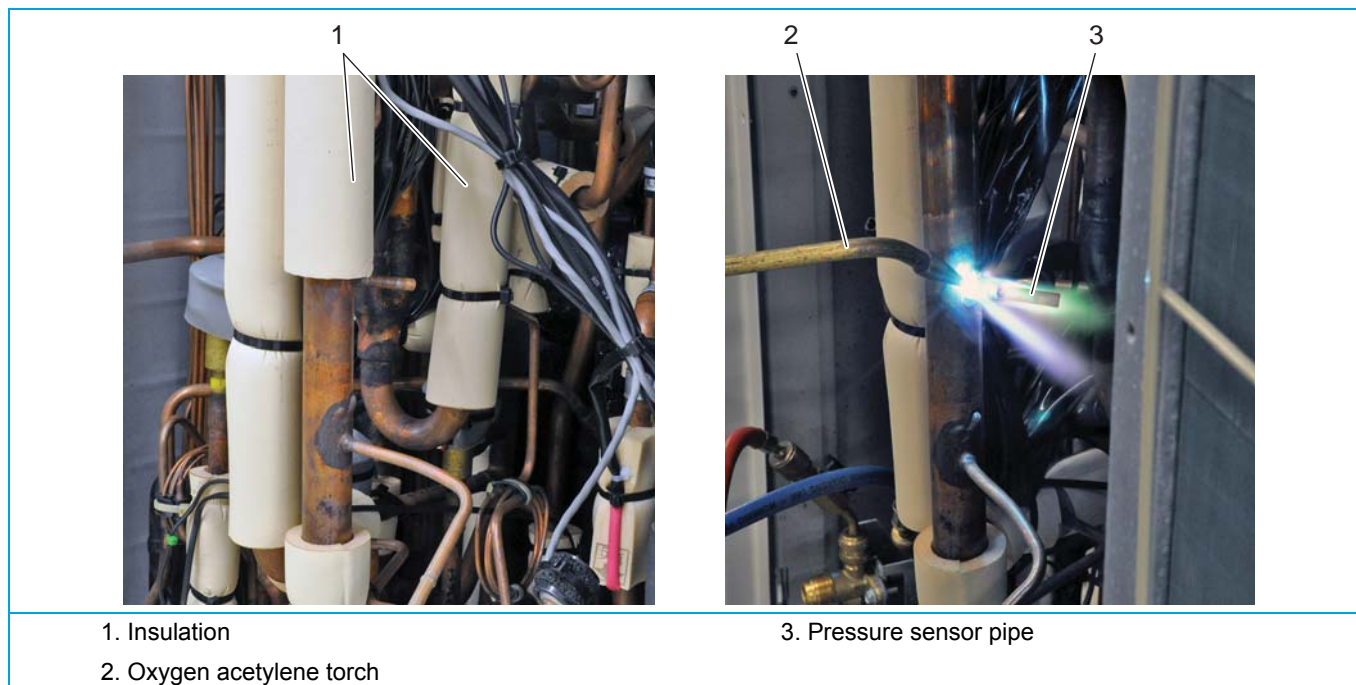
**Installation**

1. Proceed in reverse order.
2. Install a new pressure sensor (2).

**CAUTION**

Overheating the pressure sensor will damage or destroy it.

3. Cover the pressure sensor (2) with a wet cloth (3) to prevent overheating the pressure sensor (2).

Figure 50 - Installing a pressure sensor (S1NPH, S1NPL)

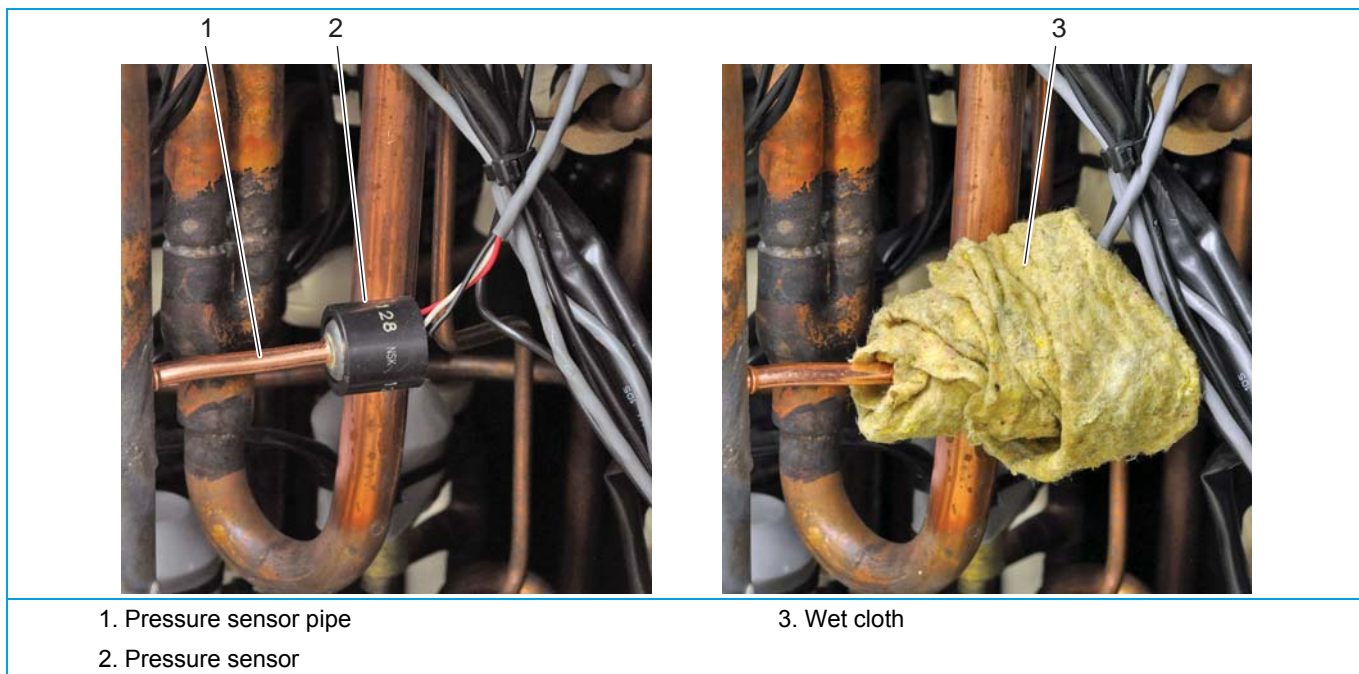
**CAUTION**

The maximum applied Nitrogen pressure must not exceed 0.02 MPa.

4. Supply nitrogen to the piping circuit.
5. Unsolder the pressure sensor pipe (1).
6. Cut the nitrogen supply when the piping has cooled down.
7. Reconnect the pressure sensor connector, refer to "[Wiring diagrams](#)" on page 215.
8. Relocate all insulation that was displaced during removal of the pressure sensor.
9. Replace all tie wraps that were cut during the pressure sensor removal.
10. Remove the hoses from the service ports.

**INFORMATION**

Relocate all insulation that was displaced during removal of the pressure sensor.
Replace all tie wraps that were cut during removal.

3.4. Replacing a pressure switch (S1PH, S2PH)

**INFORMATION**

The replacement of a pressure switch is similar to the replacement of a pressure sensor, refer to "[Replacing a pressure sensor \(S1NPH, S1NPL\)](#)" on page 147

3.5. Replacing a 4 way valve coil (Y3S,Y4S, Y5S)

Preliminary actions

1. Switch off the VRV4 Heat recovery system with the field supplied circuit breaker.
2. Remove the upper front plate assembly, refer to ["Removing the upper front plate assembly" on page 101](#).
3. Remove the switch box cover, refer to ["Removing the switch box cover" on page 103](#) (REMQ5T7Y1B, REYQ8~12T7Y1B) or ["Removing the switch box cover" on page 111](#) (REYQ14~20T7Y1B).

Procedure

The removal of the 4 way valves is illustrated in ["Removing a 4 way valve \(Y3S,Y4S, Y5S\) coil" on page 150](#).

1. Using a M8 socket, remove the screw (2) that fixes the coil (3) to the 4-way valve (1).
2. Remove the coil (3) from the 4-way valve (1).
3. Cut all tie wraps that fix the 4-way valve wiring.
4. Unplug the appropriate connector, refer to ["Wiring diagrams" on page 215](#).

Figure 51 - Removing a 4 way valve (Y3S,Y4S, Y5S) coil

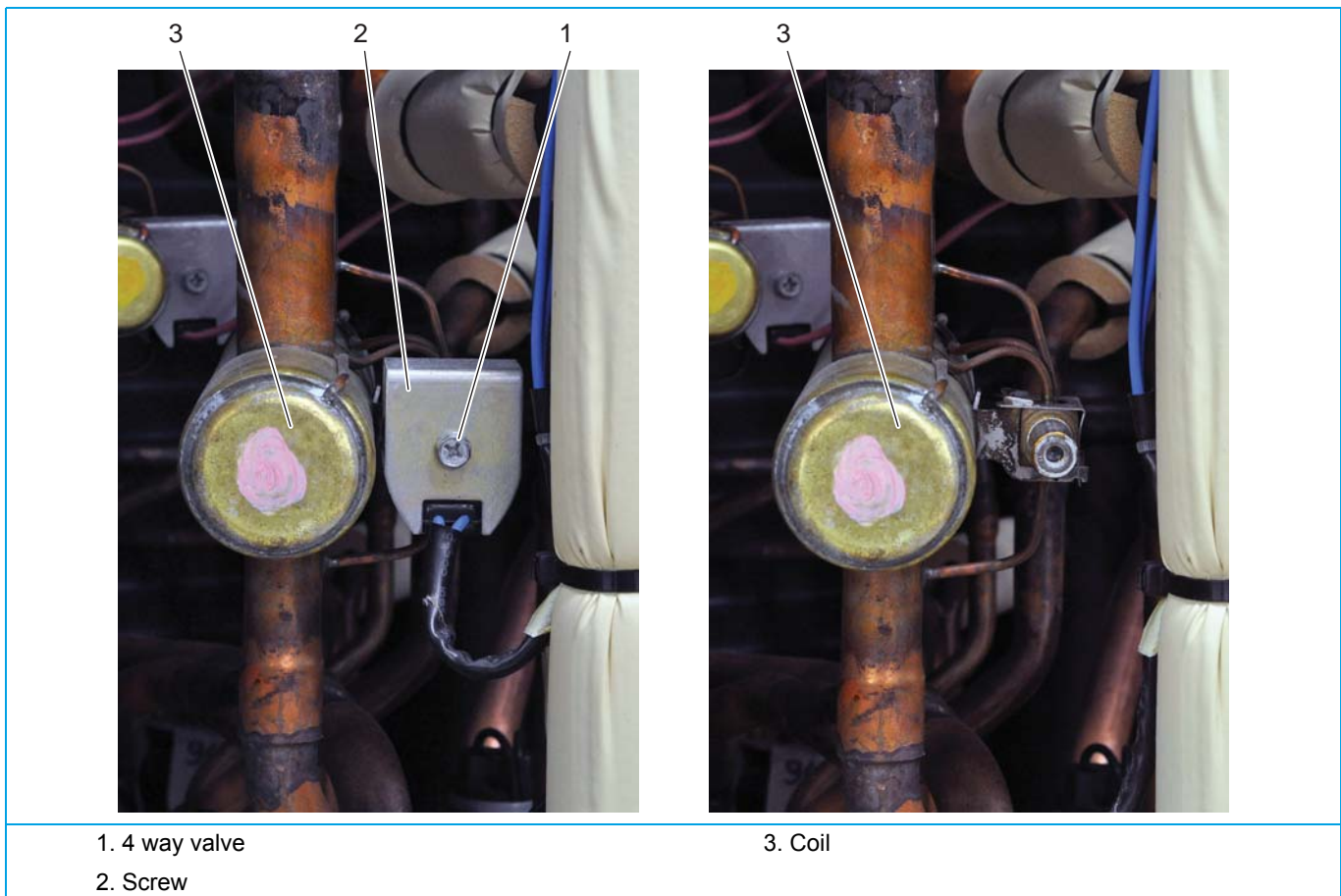

Installation



INFORMATION

Replace all tie wraps that were cut during removal.

1. Proceed in reverse order.

3.6. Replacing a solenoid valve coil (Y11S, Y12S)

Preliminary actions

1. Switch off the VRV4 Heat recovery system with the field supplied circuit breaker.
2. Remove the upper front plate assembly, refer to ["Removing the upper front plate assembly" on page 101](#).
3. Remove the switch box cover, refer to ["Removing the switch box cover" on page 103](#) (REM5T7Y1B, REYQ8~12T7Y1B) or ["Removing the switch box cover" on page 111](#) (REYQ14~20T7Y1B).

Procedure

The removal of the solenoid valves is illustrated in ["Removing a solenoid valve \(Y11S, Y12S\) coil" on page 151](#).

1. Using a M7 socket, remove the screw (2) that fixes the coil (4) to the solenoid valve (1).
2. Remove the 2 screws (3) that fix the coil (4) to the bracket (5).
3. Remove the coil (4) from the solenoid valve (1).
4. Cut all tie wraps (6) that fix the solenoid valve wiring.
5. Unplug the appropriate connector, refer to ["Wiring diagrams" on page 215](#).

Figure 52 - Removing a solenoid valve (Y11S, Y12S) coil

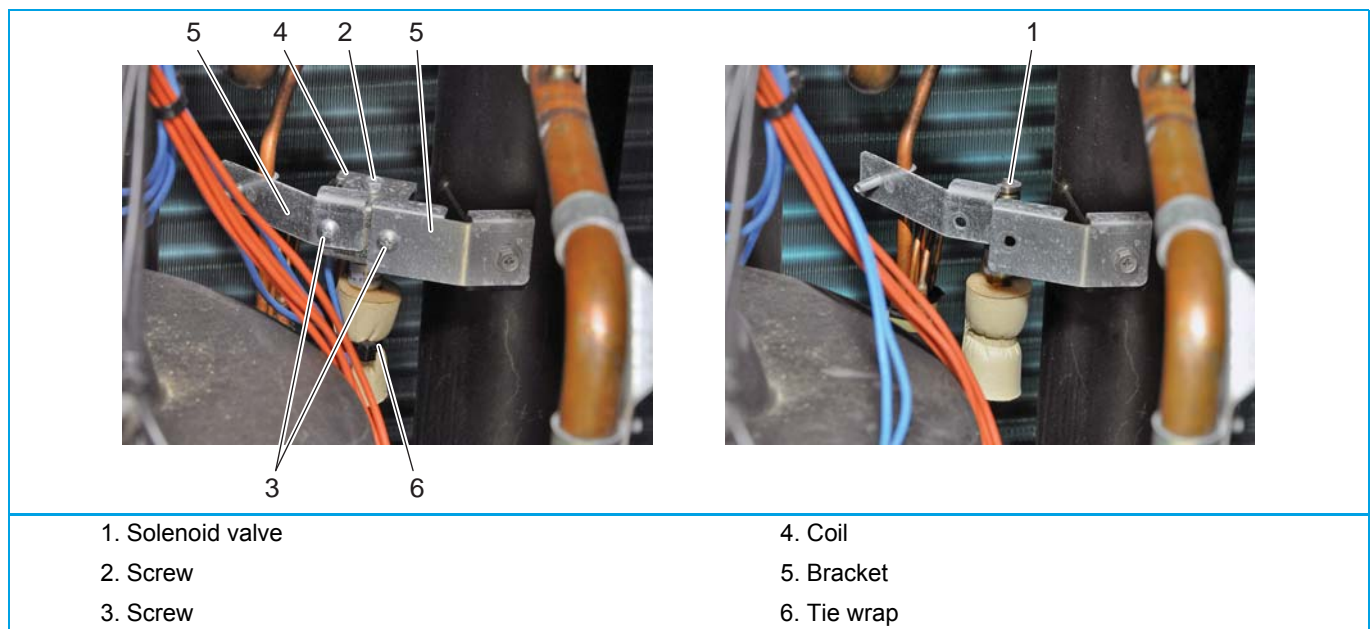

Installation



INFORMATION

Replace all tie wraps that were cut during removal.

1. Proceed in reverse order.

3.7. Replacing a solenoid valve coil (Y2S)

Preliminary actions

1. Switch off the VRV4 Heat recovery system with the field supplied circuit breaker.
2. Remove the upper front plate assembly, refer to ["Removing the upper front plate assembly" on page 101](#).
3. Remove the switch box cover, refer to ["Removing the switch box cover" on page 103](#) (REMQ5T7Y1B, REYQ8~12T7Y1B) or ["Removing the switch box cover" on page 111](#) (REYQ14~20T7Y1B).

Procedure

The removal of the solenoid valve is illustrated in ["Removing a solenoid valve \(Y2S\) coil" on page 152](#).

1. Using a M8 socket, remove the screw (2) that fixes the coil (3) to the solenoid valve (1).
2. Remove the coil (3) from the solenoid valve (1).
3. Cut all tie wraps that fix the solenoid valve wiring.
4. Unplug the appropriate connector, refer to ["Wiring diagrams" on page 215](#).

Figure 53 - Removing a solenoid valve (Y2S) coil

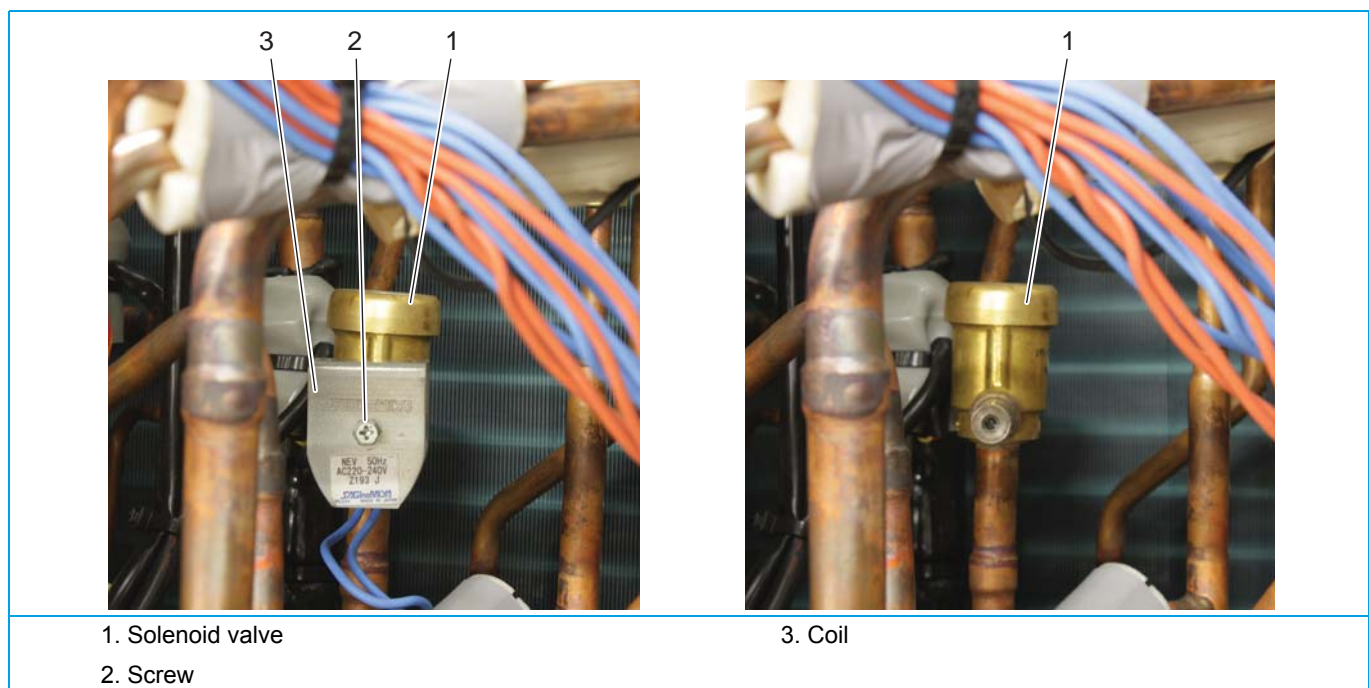

Installation



INFORMATION

Replace all tie wraps that were cut during removal.

1. Proceed in reverse order.

3.8. Replacing a 4 way valve (Y3S~Y5S)

Preliminary actions

1. Remove the heat exchanger, refer to ["Replacing the fan assembly" on page 179](#).
2. Remove the 4 way valve coil, refer to ["Replacing a 4 way valve coil \(Y3S,Y4S, Y5S\)" on page 150](#).

3.8.1. Replacing 4 way valve Y3S

Procedure

The removal of 4 way valve Y4S is illustrated in ["Removing 4 way valve Y3S" on page 154](#).

1. Connect a nitrogen hose (2) to the outdoor suction service port (1) (middle service port).
2. Attach a hose with core-depressor (4) to allow the release of the nitrogen.
 - If Y4S or Y5S is in the off condition (outdoor upper respectively middle heat-exchanger is condenser), attach a hose (4) to the outdoor liquid service port (3) (left service port).
 - If Y4S and Y5S are in the on condition (outdoor upper and middle heat-exchanger are evaporator), attach a hose (4) to the HP/LP service port (8) (right service port).
3. Cut the lower pipe of Y3S (1) between the Y3S body (2) and the weld (3).
4. Remove the 2 screws (4) from the HP/LP stop valve (5).



CAUTION

Overheating the HP/LP stop valve will damage or destroy it.

5. Wrap a wet rag around the HP/LP stop valve (5).
6. Supply nitrogen to the piping circuit.
7. Using an oxygen acetylene torch, heat the solder connection of the HP/LP pipe (7) and the HP/LP stop valve pipe (6).
8. When the solder material is liquid, pull down the HP/LP stop valve pipe (6).
9. Using an oxygen acetylene torch, heat the suction pipe (9) of Y3S at the T-connection (8).
10. When the brazing material is liquid, pull up the Y4S suction pipe (9) to separate it from the T-connection (8).
11. Using an oxygen acetylene torch, remove the part of the lower pipe of Y3S (1) from the discharge pipe (10).



INFORMATION

Note the location and orientation of the piping on the 4 way valve.
The piping on the 4 way valve must be removed and be re-used when installing the new 4 way valve.

12. Using an oxygen acetylene torch, heat and remove all piping from the Y3S (2).
13. Cut the nitrogen supply when the piping has cooled down.

Figure 54 - Removing 4 way valve Y3S

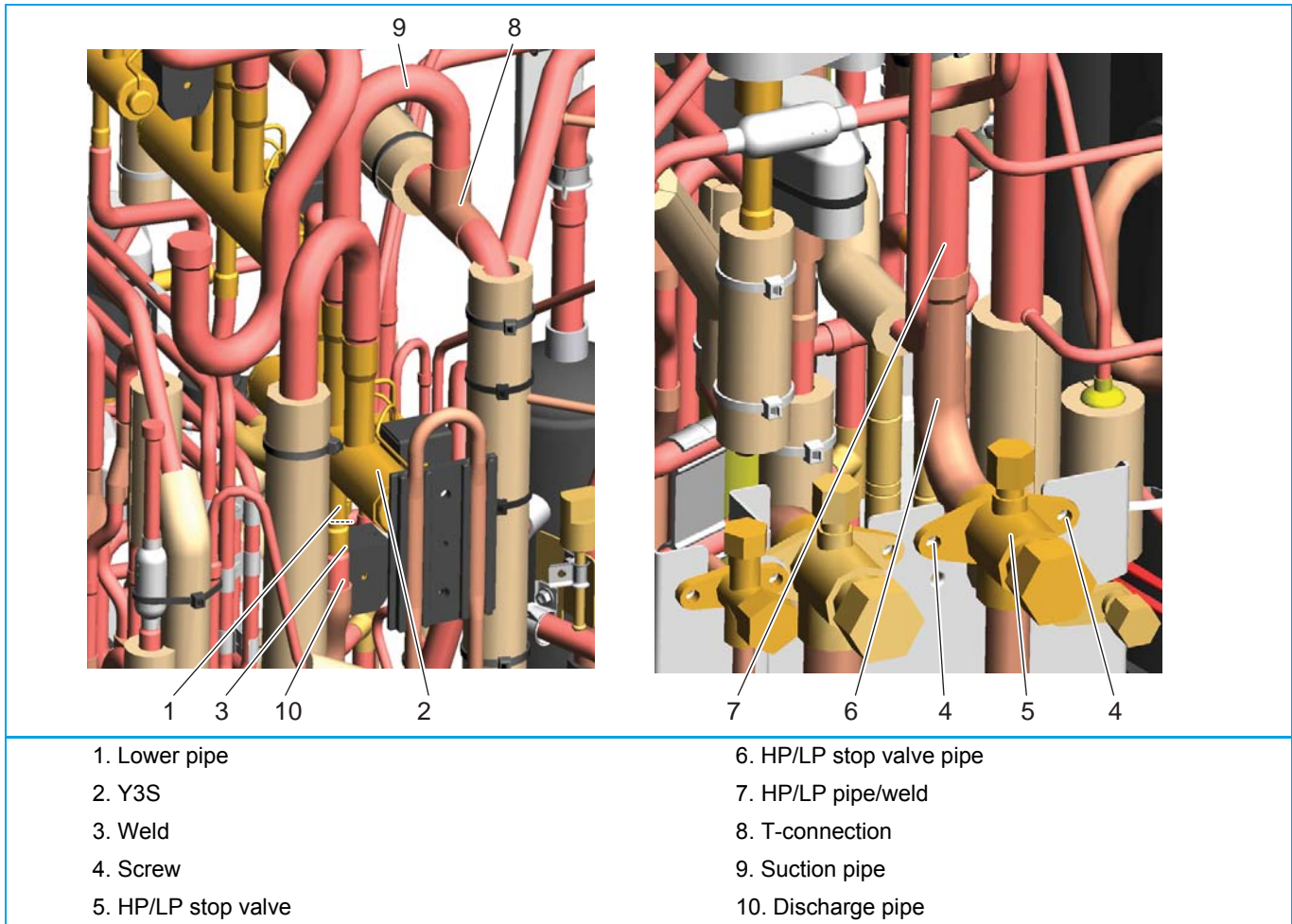

Installation



CAUTION

Overheating the 4 way valve will damage or destroy it.

1. Wrap a wet rag around the 4 way valve.



CAUTION

Install the piping in the correct location and orientation to facilitate installation.

2. Re-assemble the Y3S assembly, refer to "[Preparing a new 4 way valve Y3S assembly](#)" on page 155.
3. Using an oxygen acetylene torch, solder the piping on the new 4 way valve Y3S.

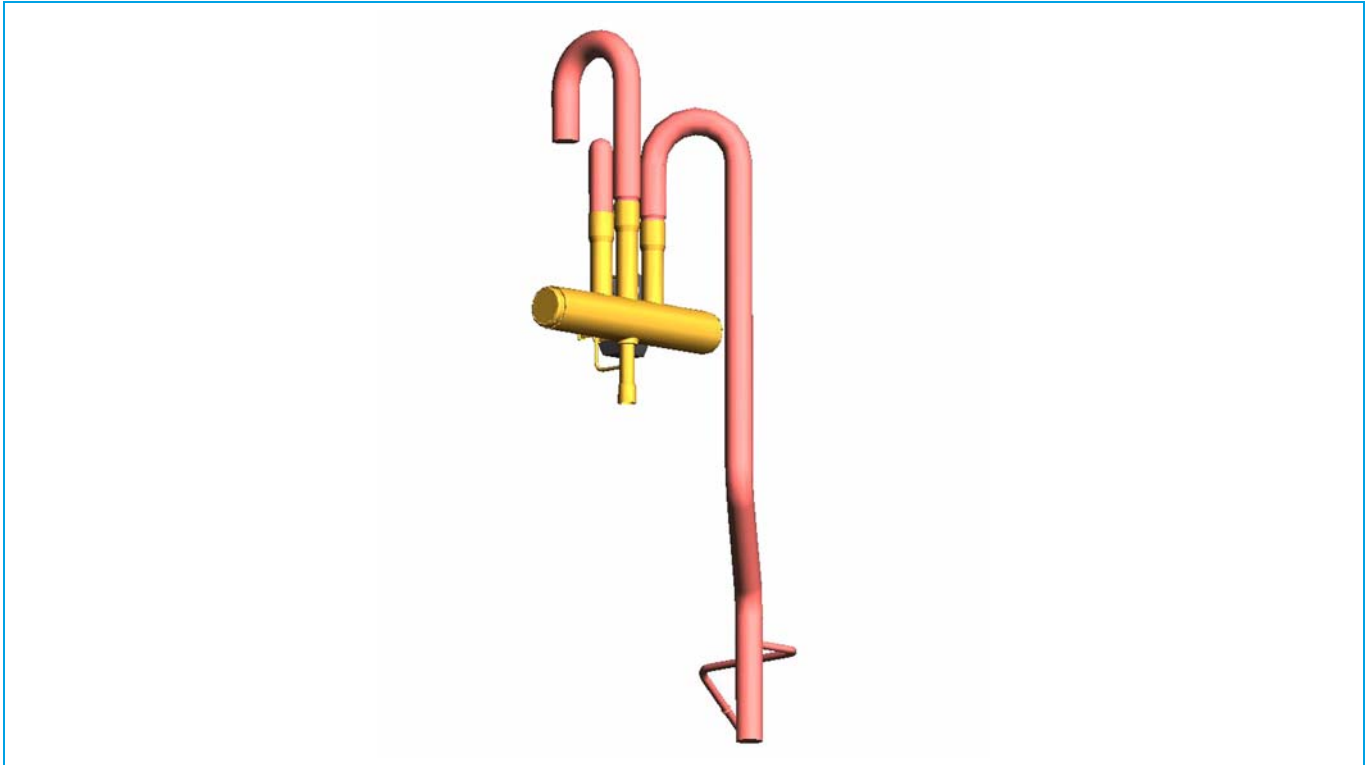
Figure 55 - Preparing a new 4 way valve Y3S assembly

4. Supply nitrogen to the piping circuit.
5. Heat the suction pipe (9) and the T-connection (8), refer to ["Removing 4 way valve Y3S" on page 154](#).

**CAUTION**

Install the 4 way valve assembly in the correct orientation to facilitate further installation.

6. When the brazing material is liquid, insert the suction pipe (9) into the T-connection (8).
7. Heat the discharge pipe (10) and the lower pipe (1) of Y3S.
8. When the brazing material is liquid, lift the discharge pipe (10) to connect it with the lower pipe of Y3S (1).
9. Wrap a wet rag around the HP/LP stop valve.
10. Heat the HP/LP stop valve pipe (6) above the HP/LP stop valve and the HP/LP pipe (7).
11. When the brazing material is liquid, Insert the HP/LP pipe (7) into the HP/LP stop valve pipe (6).
12. Solder all connections air tight.
13. Remove the wet rag from the 4 way valve and the HP/LP stop valve.
14. Insert and tighten the 2 screws (4) to fix the HP/LP stop valve (5).
15. Install the 4 way valve coil, refer to ["Replacing a 4 way valve coil \(Y3S, Y4S, Y5S\)" on page 150](#).

3.8.2. Replacing 4 way valve Y4S

Procedure

The removal of 4 way valve Y4S is illustrated in "Removing 4 way valve Y4S" on page 156.

1. Remove thermistor R9T, refer to "Replacing a thermistor" on page 145.
2. Attach a hose with core-depressor (4) to allow the release of the nitrogen.
 - If Y4S or Y5S is in the off condition (outdoor upper respectively middle heat-exchanger is condenser), attach a hose (4) to the outdoor liquid service port (3) (left service port).
 - If Y4S and Y5S are in the on condition (outdoor upper and middle heat-exchanger are evaporator), attach a hose (4) to the HP/LP service port (8) (right service port).
3. Cut the lower pipe of Y4S (1) between the Y4S body (2) and the weld (3).
4. Supply nitrogen to the piping circuit.
5. Using an oxygen acetylene torch, heat the suction pipe (5) of Y4S at the T-connection (4).
6. When the brazing material is liquid, pull the Y4S suction pipe (5) to separate it from the T-connection (4).
7. Using an oxygen acetylene torch, remove the part of the lower pipe of Y4S (1) from the discharge pipe (6).



INFORMATION

Note the location and orientation of the piping on the 4 way valve.

The piping on the 4 way valve must be removed and be re-used when installing the new 4 way valve.

8. Using an oxygen acetylene torch, heat and remove all piping from the Y4S (2).
9. Cut the nitrogen supply when the piping has cooled down.

Figure 56 - Removing 4 way valve Y4S

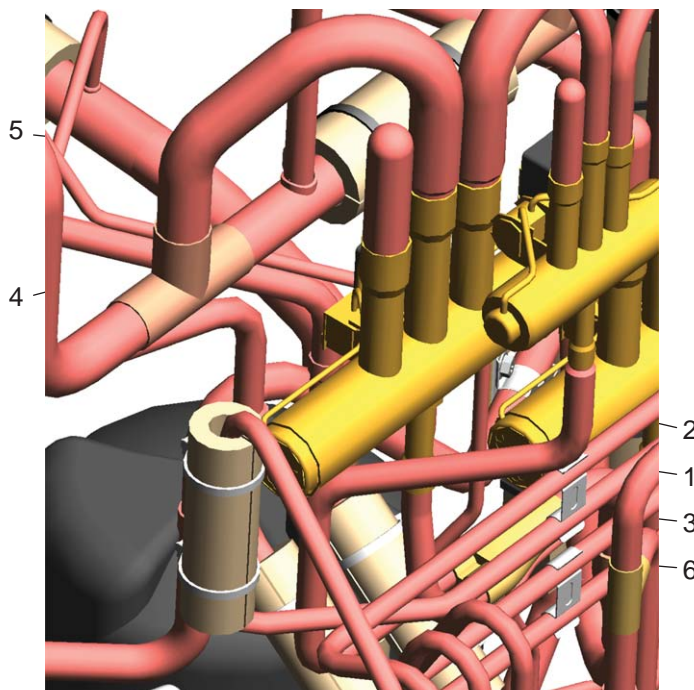

1. Lower pipe
2. Y4S
3. Weld

4. T-connection
5. Suction pipe
6. Discharge pipe

Installation

**CAUTION**

Overheating the 4 way valve will damage or destroy it.

1. Wrap a wet rag around the 4 way valve.

**CAUTION**

Install the piping in the correct location and orientation to facilitate installation.

2. Re-assemble the Y4S assembly, refer to "[Preparing a new 4 way valve Y4S assembly](#)" on page 157.
3. Using an oxygen acetylene torch, solder the piping on the new 4 way valve Y4S.

Figure 57 - Preparing a new 4 way valve Y4S assembly

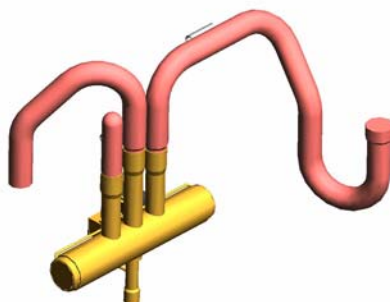

4. Supply nitrogen to the piping circuit.
5. Heat the suction pipe (5) and the T-connection (4), refer to "[Removing 4 way valve Y4S](#)" on page 156.

**CAUTION**

Install the 4 way valve assembly in the correct orientation to facilitate further installation.

6. When the brazing material is liquid, insert the suction pipe (5) into the T-connection (4).
7. Heat the discharge pipe (6) and the lower pipe (1) of Y4S.
8. When the brazing material is liquid, lift the discharge pipe (6) to connect it with the lower pipe of Y4S (1).
9. Solder all connections air tight.
10. Remove the wet rag from the 4 way valve.
11. Install the 4 way valve coil, refer to "[Replacing a 4 way valve coil \(Y3S, Y4S, Y5S\)](#)" on page 150.
12. Install thermistor R8T, refer to "[Replacing a thermistor](#)" on page 145.

3.8.3. Replacing 4 way valve Y5S

Procedure

The removal of 4 way valve Y5S is illustrated in "Removing 4 way valve Y5S" on page 158.

1. Remove thermistor R8T, refer to "Replacing a thermistor" on page 145.
2. Attach a hose with core-depressor (4) to allow the release of the nitrogen.
 - If Y4S or Y5S is in the off condition (outdoor upper respectively middle heat-exchanger is condenser), attach a hose (4) to the outdoor liquid service port (3) (left service port).
 - If Y4S and Y5S are in the on condition (outdoor upper and middle heat-exchanger are evaporator), attach a hose (4) to the HP/LP service port (8) (right service port).
3. Cut the lower pipe of Y5S (1) between the Y5S body (2) and the weld (3).
4. Using an oxygen acetylene torch, heat the suction pipe (5) of Y5S at the weld (3).
5. When the brazing material is liquid, pull the Y5S suction pipe (5) to separate it from the T-connection (4).
6. Using an oxygen acetylene torch, remove the part of the lower pipe of Y5S (1) from the discharge pipe (6).



INFORMATION

Note the location and orientation of the piping on the 4 way valve.
The piping on the 4 way valve must be removed and be re-used when installing the new 4 way valve.

7. Using an oxygen acetylene torch, heat and remove all piping from the Y5S (2).
8. Cut the nitrogen supply when the piping has cooled down.

Figure 58 - Removing 4 way valve Y5S

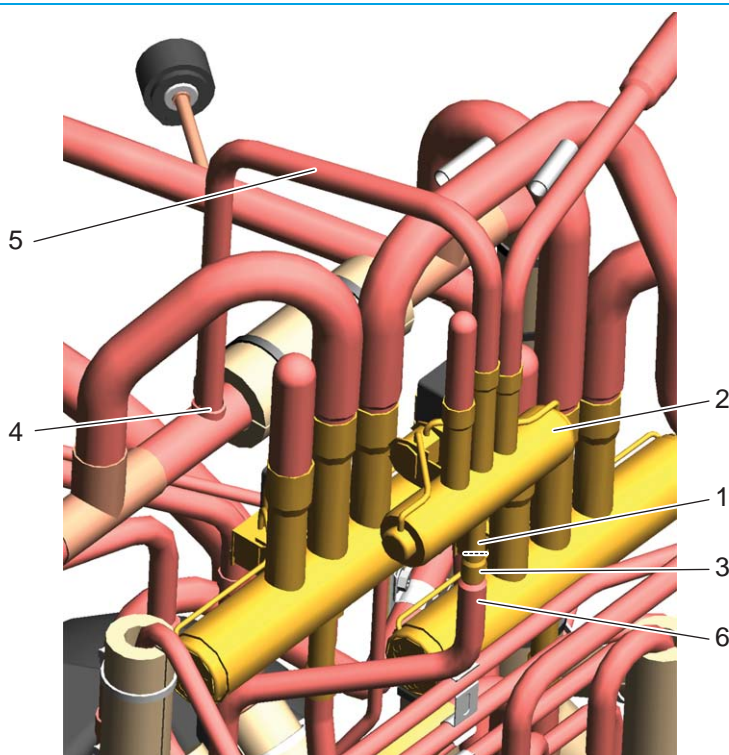

1. Lower pipe
2. Y5S
3. Weld

4. T-connection
5. Suction pipe
6. Discharge pipe

Installation

**CAUTION**

Overheating the 4 way valve will damage or destroy it.

1. Wrap a wet rag around the 4 way valve.

**CAUTION**

Install the piping in the correct location and orientation to facilitate installation.

2. Re-assemble the Y5S assembly, refer to "[Preparing a new 4 way valve Y5S assembly](#)" on page 159.
3. Using an oxygen acetylene torch, solder the piping on the new 4 way valve Y5S.

Figure 59 - Preparing a new 4 way valve Y5S assembly

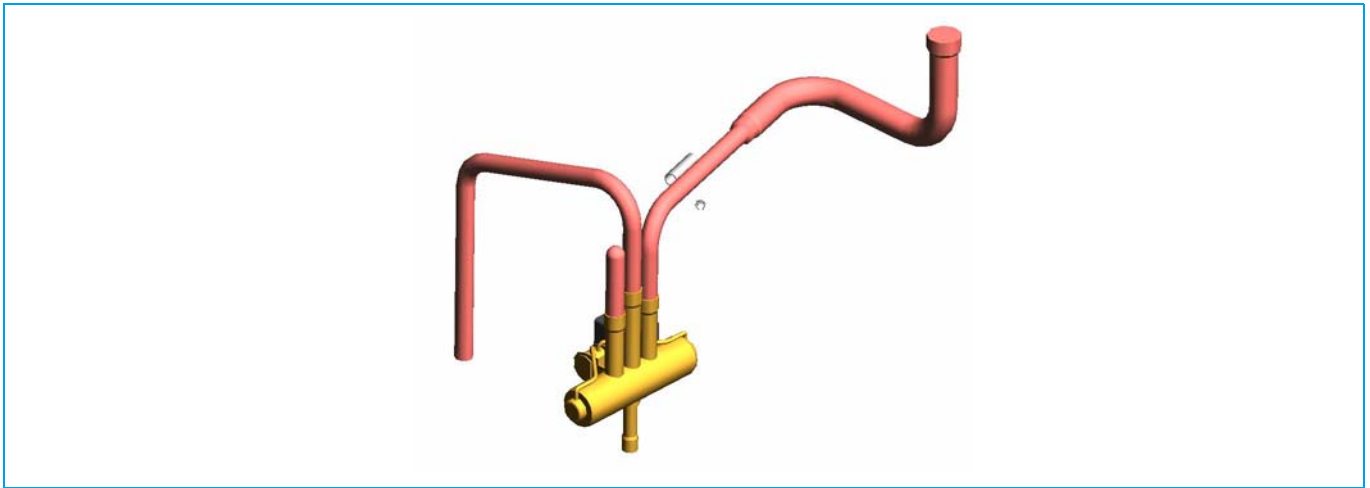

4. Supply nitrogen to the piping circuit.
5. Heat the suction pipe (5) and the T-connection (4), refer to "[Removing 4 way valve Y4S](#)" on page 156.

**CAUTION**

Install the 4 way valve assembly in the correct orientation to facilitate further installation.

6. When the brazing material is liquid, insert the suction pipe (5) into the T-connection (4).
7. Heat the discharge pipe (6) and the lower pipe of Y5S (1).
8. When the brazing material is liquid, lift the discharge pipe (6) to connect it with the lower pipe (1) of Y5S.
9. Solder all connections air tight.
10. Remove the wet rag from the 4 way valve.
11. Install the 4 way valve coil, refer to "[Replacing a 4 way valve coil \(Y3S, Y4S, Y5S\)](#)" on page 150.
12. Install thermistor R8T, refer to "[Replacing a thermistor](#)" on page 145.

3.9. Replacing a solenoid valve (Y11S, Y12S, Y2S)

**INFORMATION**

The replacement of a solenoid valve is similar to the replacement of an expansion valve, refer to "[Replacing an expansion valve coil \(Y2E, Y5E\)](#)" on page 162

3.10. Replacing an expansion valve coil (Y1E, Y3E, Y4E, Y6E)

Preliminary actions

1. Remove the upper front plate assembly, refer to ["Removing the upper front plate assembly" on page 101](#).
2. Remove the switch box cover, refer to ["Removing the switch box cover" on page 103](#) (REMQ5T7Y1B, REYQ8~12T7Y1B) or ["Removing the switch box cover" on page 111](#) (REYQ14~20T7Y1B).

Procedure

The removal of the expansion valves is illustrated in ["Removing an expansion valve \(Y1E, Y3E, Y4E, Y6E\) coil" on page 160](#).

1. Cut the tie wrap (1).
2. Remove the soft cover (2).
3. Turn the expansion valve coil (3) 1/8th turn counter clockwise to unlock it.
4. Remove the expansion valve coil (3) from the expansion valve (4).
5. Cut all tie wraps that fix the coil wiring.
6. Unplug the appropriate connector, refer to ["Wiring diagrams" on page 215](#).

Figure 60 - Removing an expansion valve (Y1E, Y3E, Y4E, Y6E) coil

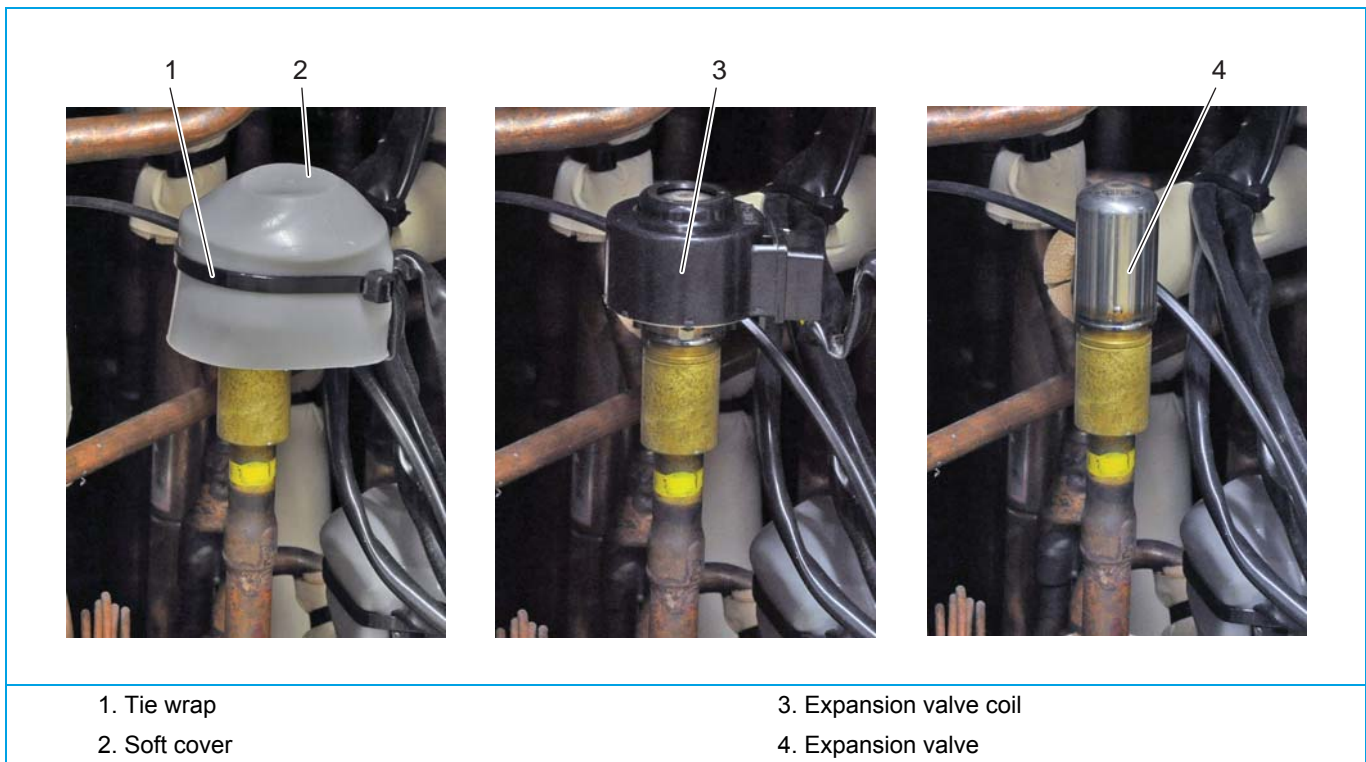

Installation**INFORMATION**

Replace all tie wraps that were cut during removal.

1. Proceed in reverse order.

**INFORMATION**

The Y1E, Y3E, Y4E, Y6E coils are equipped with a latching mechanism, turn the coil to lock it on the expansion valve.

2. When installing the expansion valve coil (3), lock it on the expansion valve.

Figure 61 - Locking an expansion valve (Y1E, Y3E, Y4E, Y6E) coil

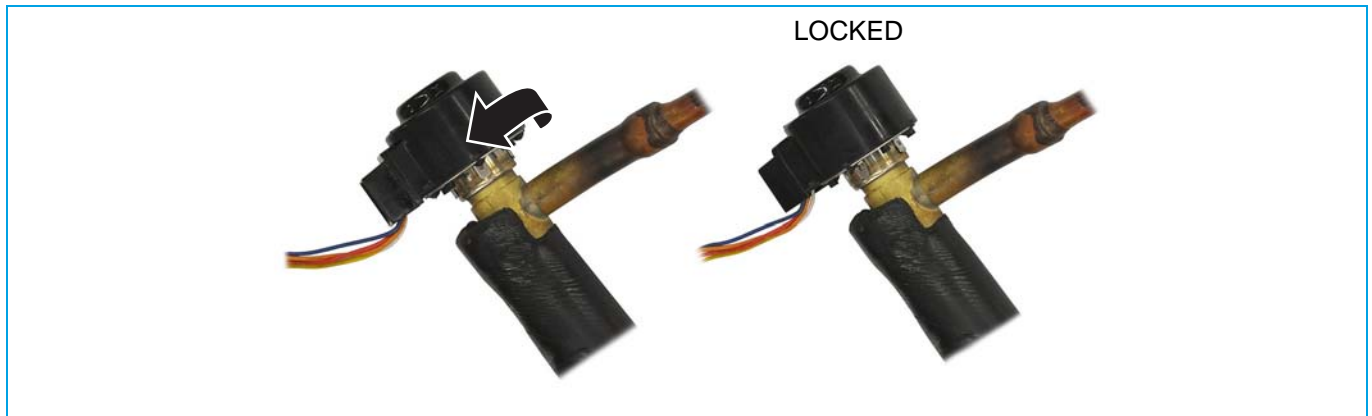

3.11. Replacing an expansion valve coil (Y2E, Y5E)

Preliminary actions

1. Remove the upper front plate assembly, refer to ["Removing the upper front plate assembly" on page 101](#).
2. Remove the switch box cover, refer to ["Removing the switch box cover" on page 103](#) (REMQ5T7Y1B, REYQ8~12T7Y1B) or ["Removing the switch box cover" on page 111](#) (REYQ14~20T7Y1B).

Procedure

The position of the motorized expansion valves is illustrated in ["Removing an expansion valve \(Y1E, Y3E, Y4E, Y6E\) coil" on page 160](#).

1. Cut the tie wrap (1).
2. Remove the soft cover (2).
3. Turn the expansion valve motor (3) 1/8th turn counter clockwise to unlock it.
4. Remove the expansion valve motor (3) from the expansion valve (4).
5. Cut all tie wraps 6 that fix the coil wiring.
6. Unplug the appropriate connector, refer to ["Wiring diagrams" on page 215](#).

Figure 62 - Removing an expansion valve (Y2E, Y5E) coil

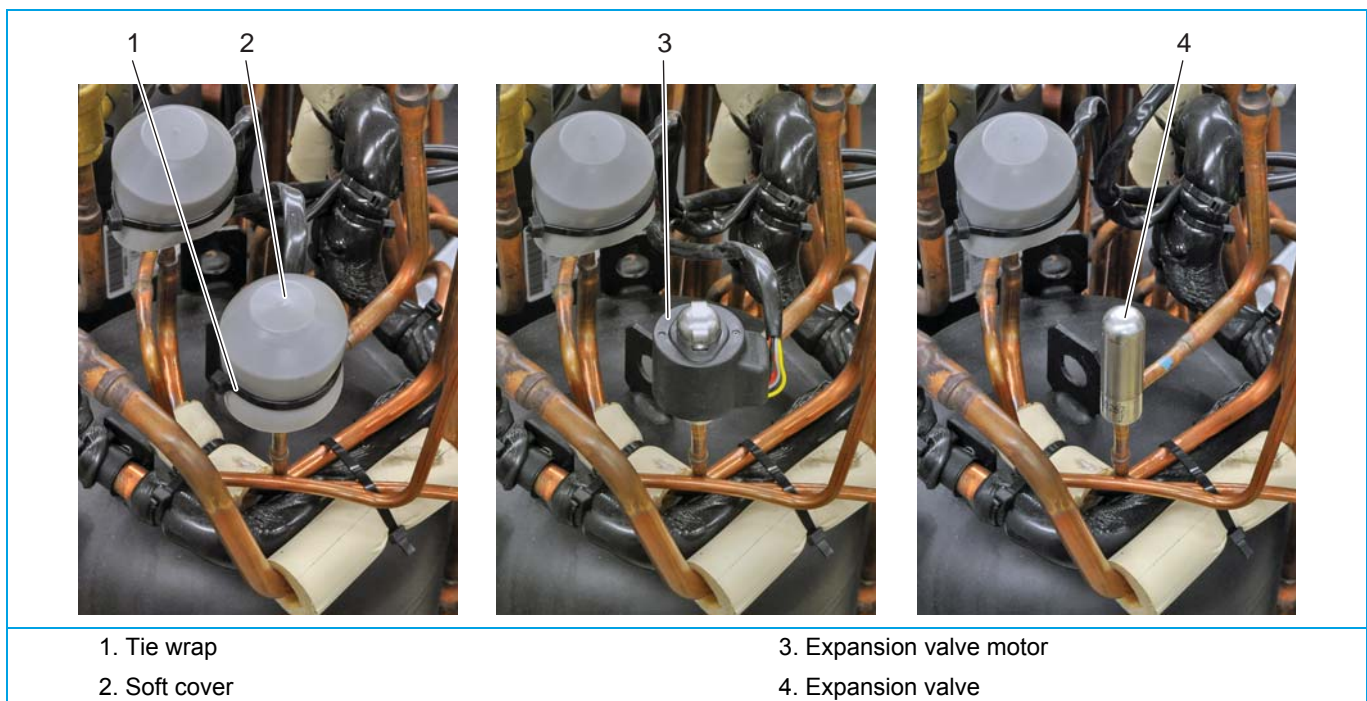

Installation



INFORMATION

Replace all tie wraps that were cut during removal.

1. Proceed in reverse order.



INFORMATION

The Y2S coil is equipped with a pipe retention clip (1), the pipe retention clip (1) must be placed over the pipe (2) to lock the coil.

The Y5S coil is equipped with a latching mechanism, turn the coil to lock it on the expansion valve.

2. When installing the expansion valve motor (3), lock it on the expansion valve.

Figure 63 - Locking an expansion valve (Y2E, Y5E) coil

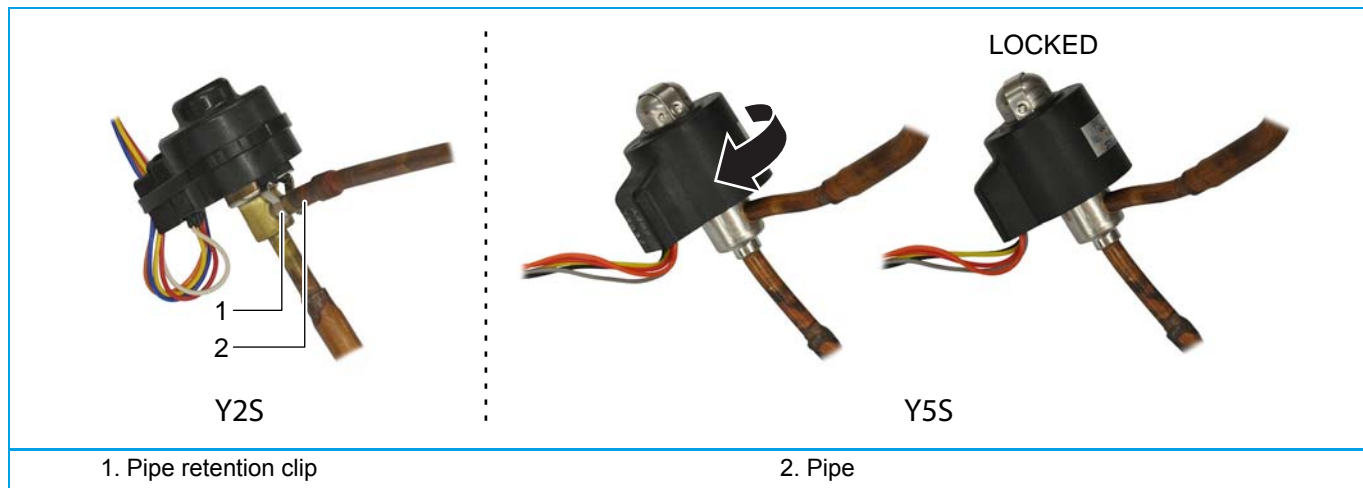

3.12. Replacing an expansion valve

Preliminary actions

1. Remove the upper front plate assembly, refer to ["Removing the upper front plate assembly" on page 101](#).
2. Remove the switch box cover, refer to ["Removing the switch box cover" on page 103](#) (REMQ5T7Y1B, REYQ8~12T7Y1B) or ["Removing the switch box cover" on page 111](#) (REYQ14~20T7Y1B).
3. Recover the refrigerant, refer to ["Refrigerant Handling" on page 95](#).
4. Remove the expansion valve coil, refer to ["Replacing an expansion valve coil \(Y1E, Y3E, Y4E, Y6E\)" on page 160](#) or ["Replacing an expansion valve coil \(Y2E, Y5E\)" on page 162](#).

Procedure

The removal of an expansion valve is illustrated in ["Removing an expansion valve" on page 165](#).

1. Connect a nitrogen hose (2) to the outdoor suction service port (1) (middle service port).
2. Attach a hose with core-depressor (4) to allow the release of the nitrogen.
 - If Y4S or Y5S is in the off condition (outdoor upper respectively middle heat-exchanger is condenser), attach a hose (4) to the outdoor liquid service port (3) (left service port).
 - If Y4S and Y5S are in the on condition (outdoor upper and middle heat-exchanger are evaporator), attach a hose (4) to the HP/LP service port (9) (right service port).
3. Remove the insulation surrounding the expansion valve (6).
4. Put aside the electrical wiring in the neighbourhood of the expansion valve (6).
5. Using a pipe cutter (5), cut one pipe of the expansion valve (6).
6. Using a pipe cutter (5), cut the other pipe of the expansion valve (6).



CAUTION

The maximum applied Nitrogen pressure must not exceed 0.02 MPa.

7. Supply nitrogen to the piping circuit.
8. Heat the ends of expansion valve pipe (8) using an oxygen acetylene torch, remove the expansion valve pipe ends (8).
9. Cut the nitrogen supply when the piping has cooled down.

Figure 64 - Removing an expansion valve

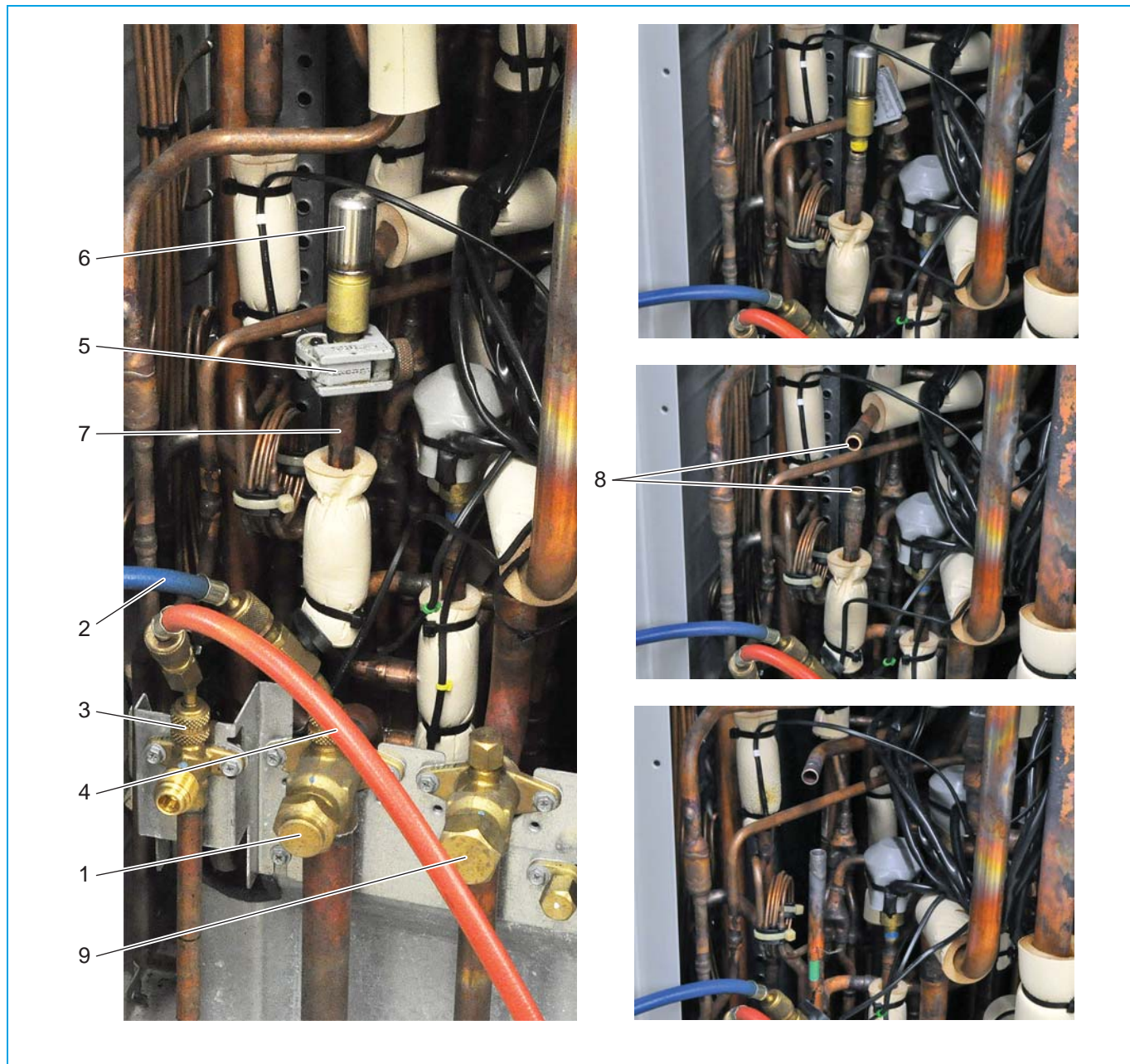

- 1. Outdoor suction service port
- 2. Nitrogen hose
- 3. Outdoor liquid service port
- 4. Hose (with core depressor) to release nitrogen
- 5. Pipe cutter

- 6. Expansion valve
- 7. Expansion valve pipe
- 8. Expansion valve pipe ends
- 9. HP/LP service port

Installation

1. Install a new expansion valve (1).

**CAUTION**

Overheating the expansion valve will damage or destroy it.

2. Cover the expansion valve (1) with a wet cloth (3) to prevent overheating the expansion valve (1).

Figure 65 - Installing an expansion valve

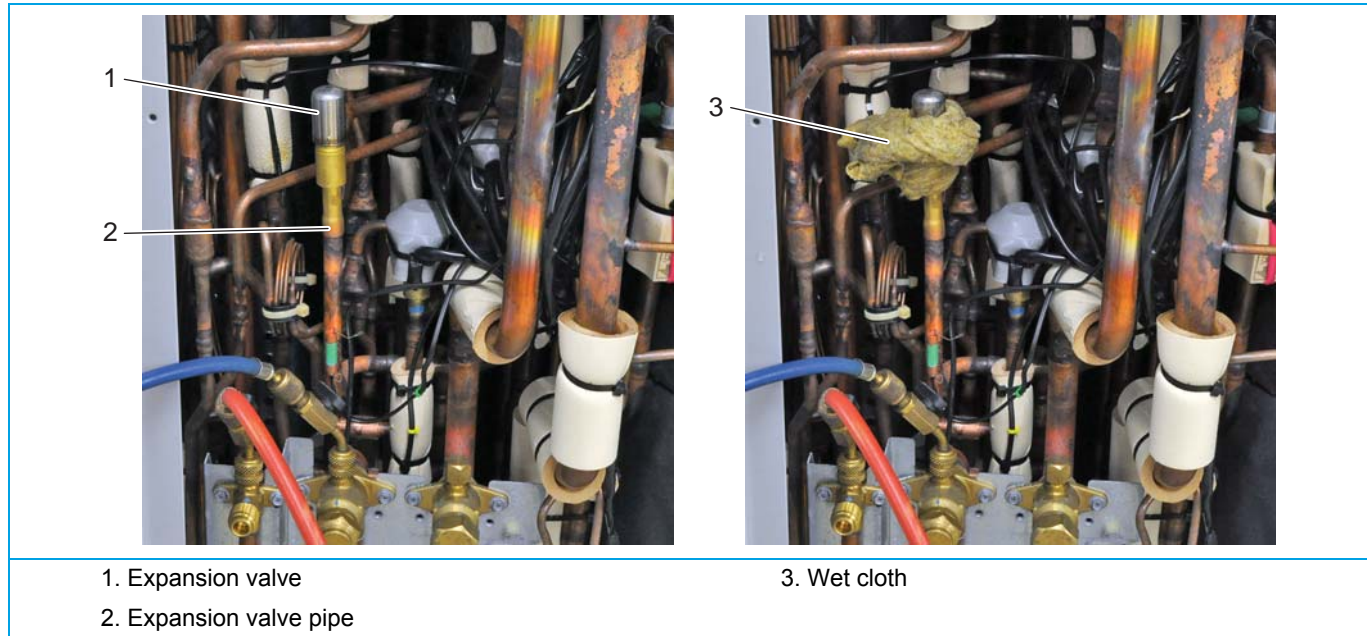
**CAUTION**

The maximum applied Nitrogen pressure must not exceed 0.02 MPa.

3. Supply nitrogen to the piping circuit.
4. Solder the expansion valve (1).
5. Cut the nitrogen supply when the piping has cooled down.
6. Install the coil on the expansion valve.
7. Relocate all insulation that was displaced during removal of the expansion valve.
8. Replace all tie wraps that were cut during the expansion valve removal.
9. Remove the hoses from the service ports.

3.13. Replacing a fan propeller

Preliminary actions

1. Switch off the VRV4 Heat recovery system with the field supplied circuit breaker.
2. Remove the upper front plate assembly, refer to ["Removing the upper front plate assembly" on page 101.](#)
3. Remove the top plate, refer to ["Removing the top plate" on page 107.](#)

Procedure

The removal of the fan propeller is illustrated in ["Removing a fan propeller" on page 167.](#)

1. Loosen the screw (2) using an Allen key n° 5 (3).
2. Remove the axle cover (4).



CAUTION

Do NOT use a hammer to remove the propeller.

3. Pull the propeller (1) from the fan motor axle (1). Use a pulley remover (5) if the propeller (1) cannot be removed manually.

Figure 66 - Removing a fan propeller

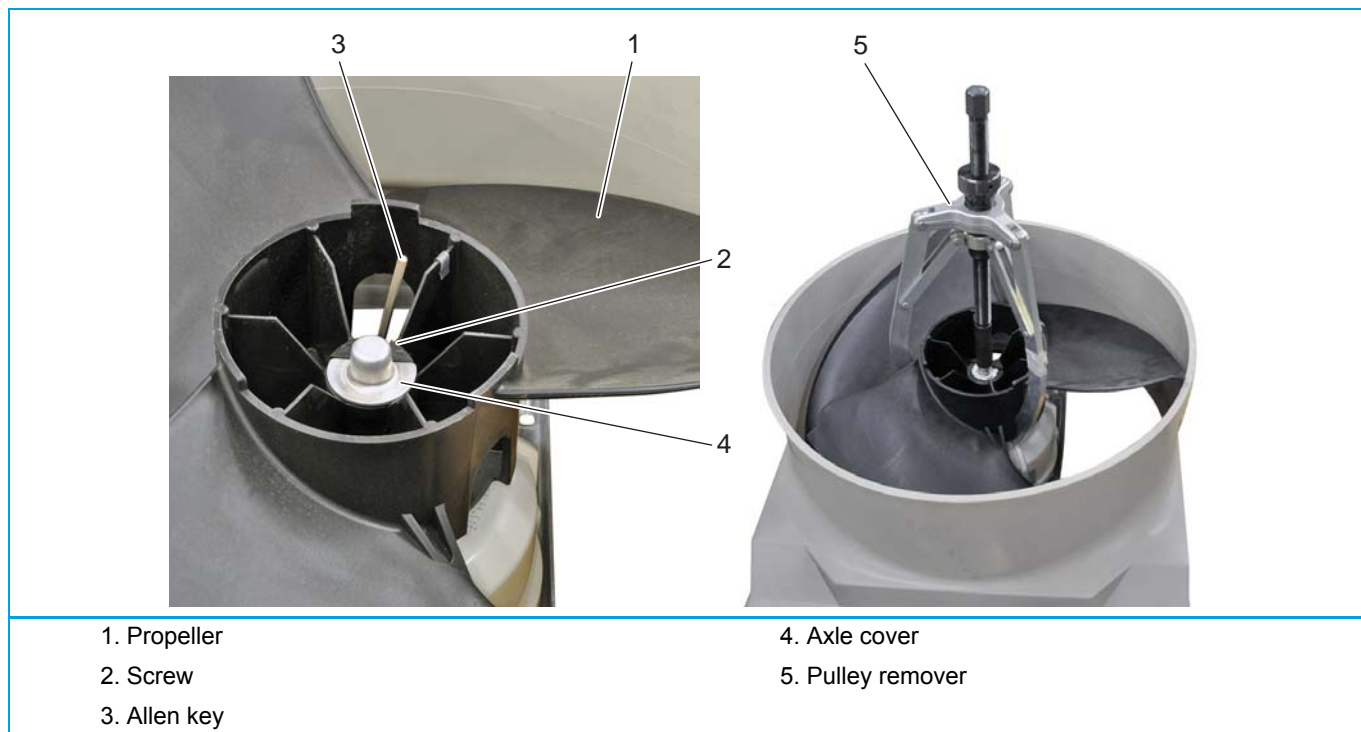

Installation



CAUTION

Do not install a damaged propeller.

1. Proceed in reverse order.

3.14. Replacing a fan motor

Preliminary actions

1. Switch off the VRV4 Heat recovery system with the field supplied circuit breaker.
2. Remove the upper front plate assembly, refer to ["Removing the upper front plate assembly" on page 101](#).
3. Remove the switch box cover, refer to ["Removing the switch box cover" on page 103](#) (REMQ5T7Y1B, REYQ8~12T7Y1B) or ["Removing the switch box cover" on page 111](#) (REYQ14~20T7Y1B).
4. Remove the fan propeller, refer to ["Replacing a fan propeller" on page 167](#).

Procedure

The position of the fan motors is illustrated in ["Removing a fan propeller" on page 167](#).

1. Cut the tie wraps that fix the fan motor cable (4).
2. Cut the tie wrap (3) that fixes the fan motor cable (4).
3. Remove the 4 screws (2) that fix the fan motor (1).



INFORMATION

The dampers and bushing must be installed on the new fan motor.

Figure 67 - Removing a fan motor



1. Fan motor

2. Screw

3. Tie wrap

4. Fan motor cable

Installation



INFORMATION

Replace all tie wraps that were cut during removal.

1. Proceed in reverse order.

3.15. Replacing a compressor

Preliminary actions

1. Remove the front plate assembly, refer to ["Removing the front plate assembly" on page 102.](#)
2. Recover the refrigerant, refer to ["Refrigerant Handling" on page 95.](#)
3. Displace the bracket (1), refer to ["Displacing a bracket" on page 124](#) and slide the insulation (2) upwards.

Figure 68 - Displacing the insulation

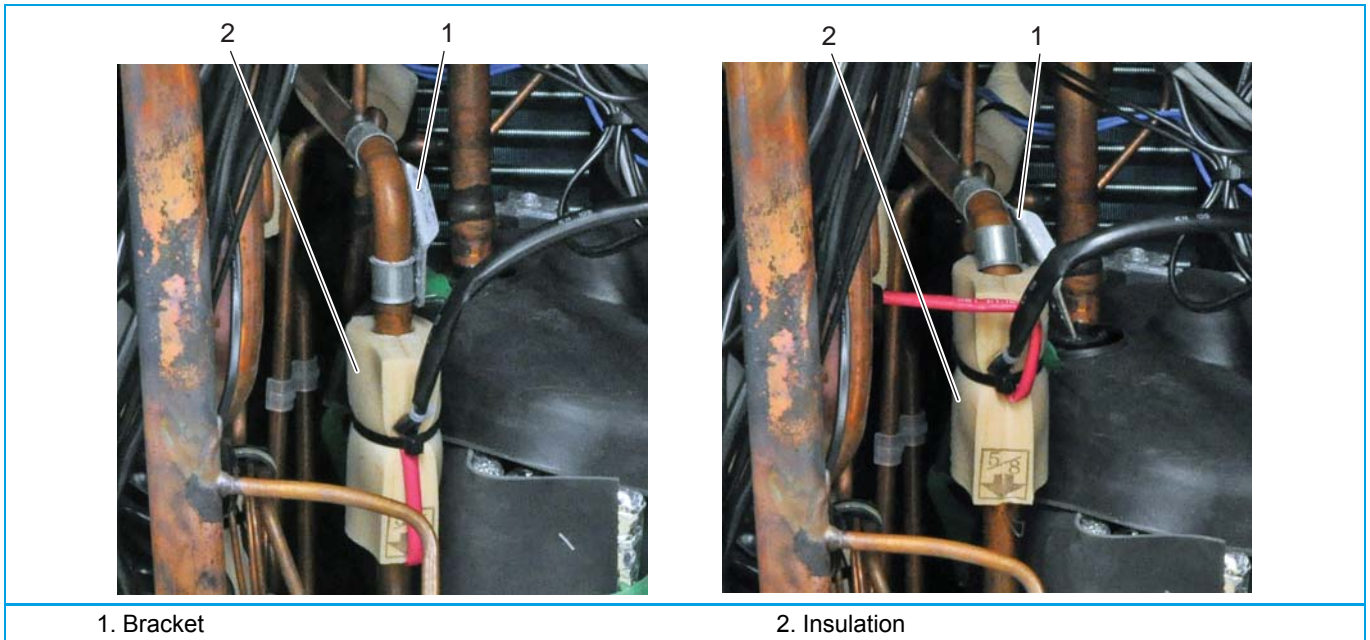

Procedure

The removal of the compressor is illustrated in ["Removing the compressor insulation and wiring" on page 170.](#)

1. Open the insulation (2) of the compressor by pulling the velcro strips (1).
2. If the compressor is equipped with a body thermistor (R15T), remove the body thermistor from its support, refer to ["Replacing a thermistor" on page 145.](#)



INFORMATION

A J-type compressor has 2 layers of insulation, both layers must be removed.

3. Remove the insulation (2) from the compressor.

Figure 69 - Removing the compressor insulation and wiring

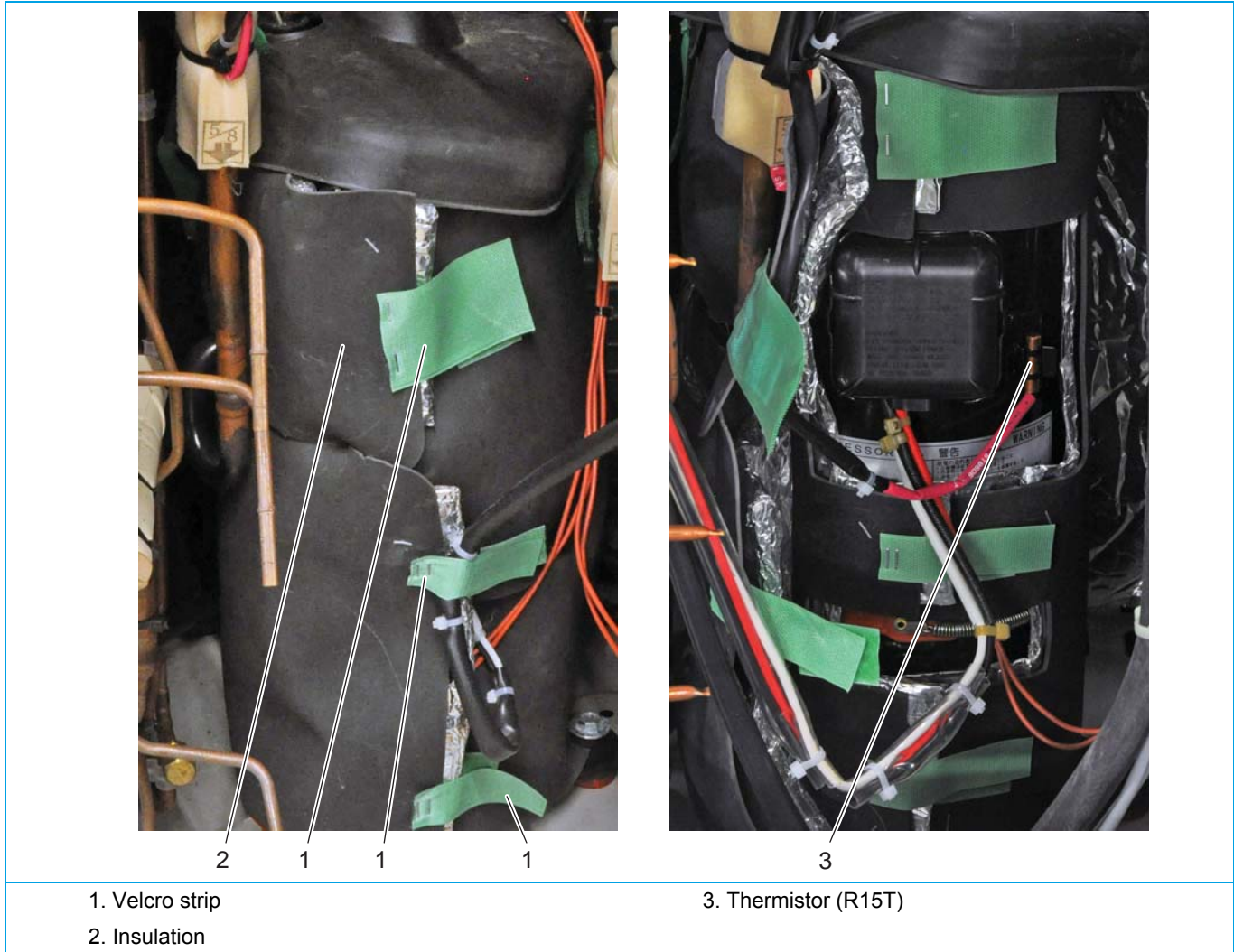

4. Remove the crankcase heater, refer to "[Replacing a crankcase heater E1HC, E2HC](#)" on page 174.

- 5. Remove the cover (1) from the compressor junction box.
- 6. Remove the wiring (2) from the compressor.

Figure 70 - Removing the compressor wiring

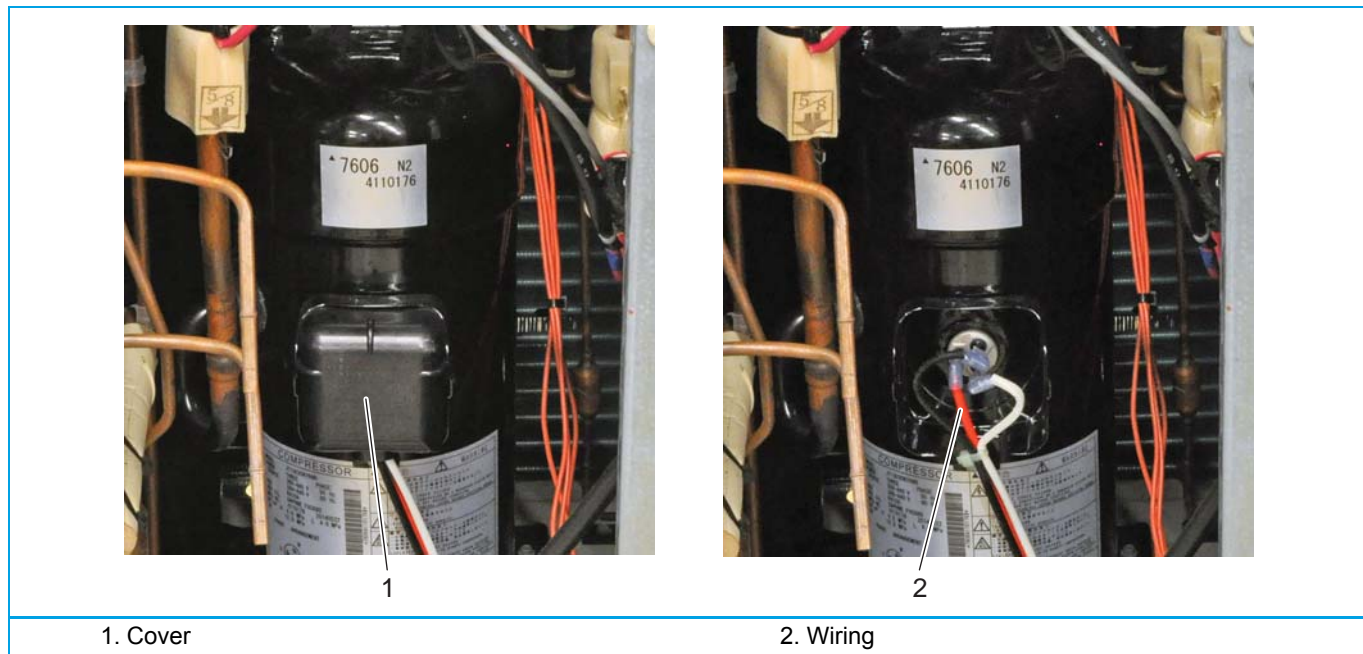

- 7. Using a pipe cutter (2), cut the compressor pipes (3).

Figure 71 - Cutting the compressor piping

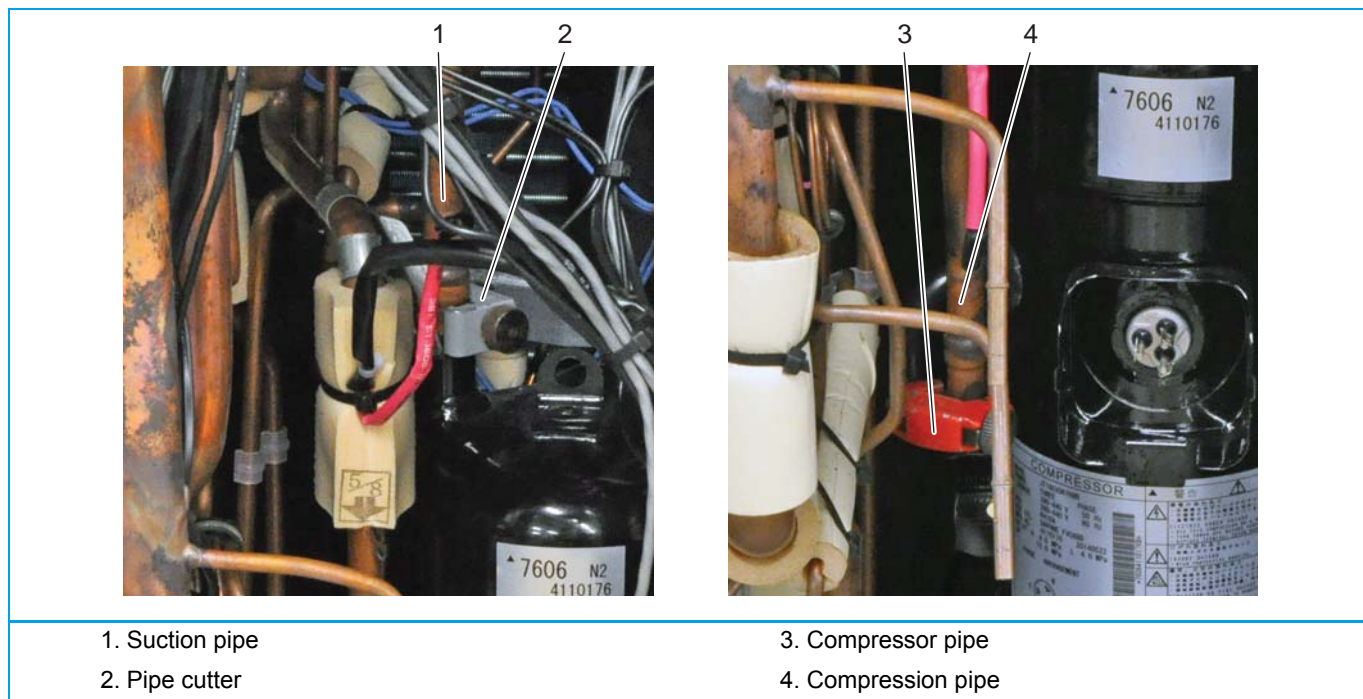

8. Using an M13 spanner, remove the 3 screws (1) that fix the compressor (2).
9. Remove the compressor (2).
10. Remove the dampers (3) with bushings (4) from the compressor (2).

Figure 72 - Removing the compressor

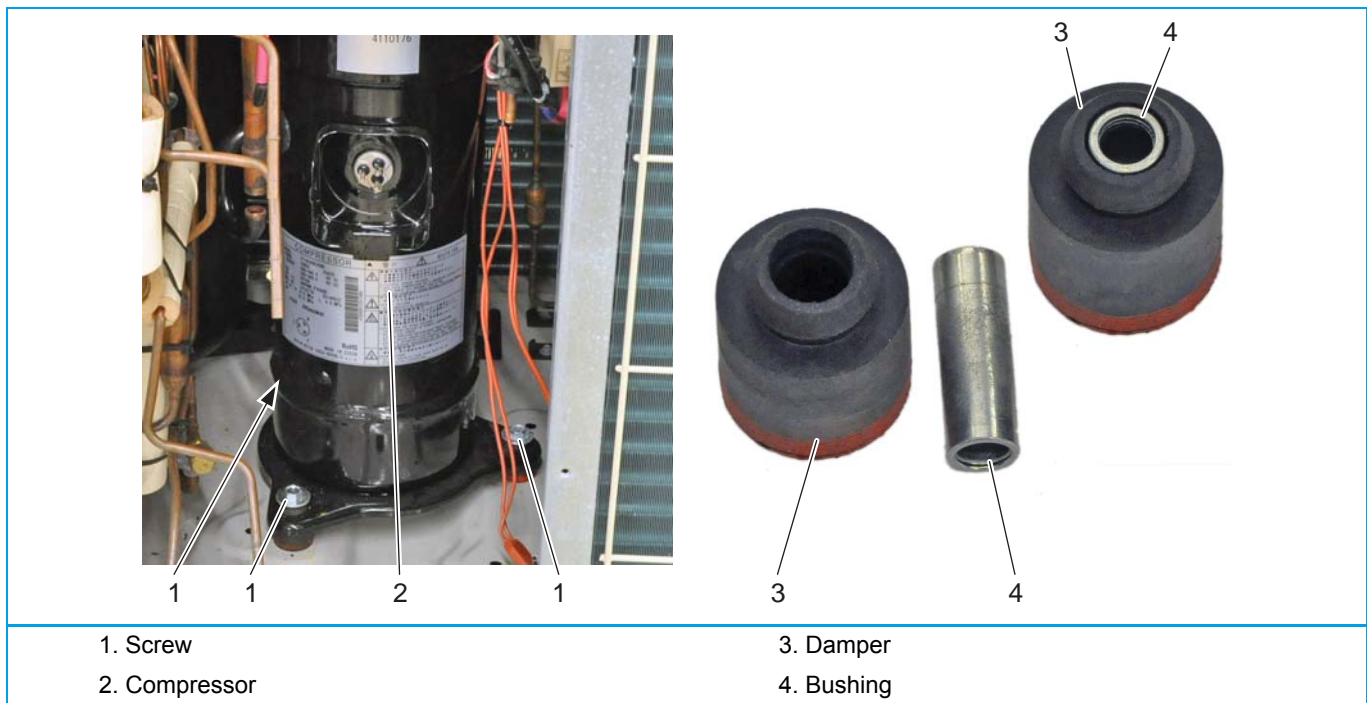

11. Connect a nitrogen hose to the outdoor suction service port (middle service port).

**CAUTION**

The maximum applied Nitrogen pressure must not exceed 0.02 MPa.

12. Supply nitrogen to the piping circuit.
13. Heat the ends of the compression pipe using an oxygen acetylene torch, remove the ends of compressor pipes.
14. Cut the nitrogen supply when the piping has cooled down.
15. Connect a nitrogen hose to the outdoor liquid service port (left service port).

**CAUTION**

The maximum applied Nitrogen pressure must not exceed 0.02 MPa.

16. Supply nitrogen to the piping circuit.
17. Heat the ends of the suction pipe using an oxygen acetylene torch, remove the ends of compressor pipe.
18. Cut the nitrogen supply when the piping has cooled down.

Installation**CAUTION**

The oil in the compressor is hygroscopic. Remove the caps from the compressor piping as late as possible.



INFORMATION

Before installing a new compressor, determine the cause of the compressor failure and take all required corrective actions.



INFORMATION

If the dampers are worn, replace the dampers. The bushings inside the dampers are recuperated for use with the new dampers.

1. Check damper status, replace when worn.
2. First install the 3 (new) dampers (without the bushings) on the new compressor.
3. Install the 3 bushings in the dampers.
4. When installing the new compressor, remove the caps (2) from the compression pipe (1) and the suction pipe (3) as late as possible.

Figure 73 - Installing a new compressor - 1



5. Insert a lint-free cloth (3) into the compression pipe (2) to lower the oil in the compression pipe to the indicated oil level (4).

Figure 74 - Installing a new compressor - 2



6. When soldering the compressor pipes, cover the compressor pipes with a wet cloth to prevent overheating the compressor (and the oil in the compression pipe).
7. Proceed in reverse order.

3.16. Replacing a crankcase heater E1HC, E2HC

Preliminary actions

1. Remove the upper front plate assembly, refer to ["Removing the upper front plate assembly" on page 101.](#)
2. Remove the front plate assembly, refer to ["Removing the front plate assembly" on page 102.](#)

Procedure

The removal of a crankcase heater is illustrated in ["Removing a crankcase heater" on page 174.](#)

1. Remove the isolation from the compressor, refer to ["Replacing a compressor" on page 169](#)
2. Detach the spring (1) that fixes the crankcase heater on the compressor.
3. Remove the crankcase heater.
4. Cut the tie wraps that fix the crankcase heater (4).
5. Unplug the appropriate connector, refer to ["Wiring diagrams" on page 215.](#)

Figure 75 - Removing a crankcase heater

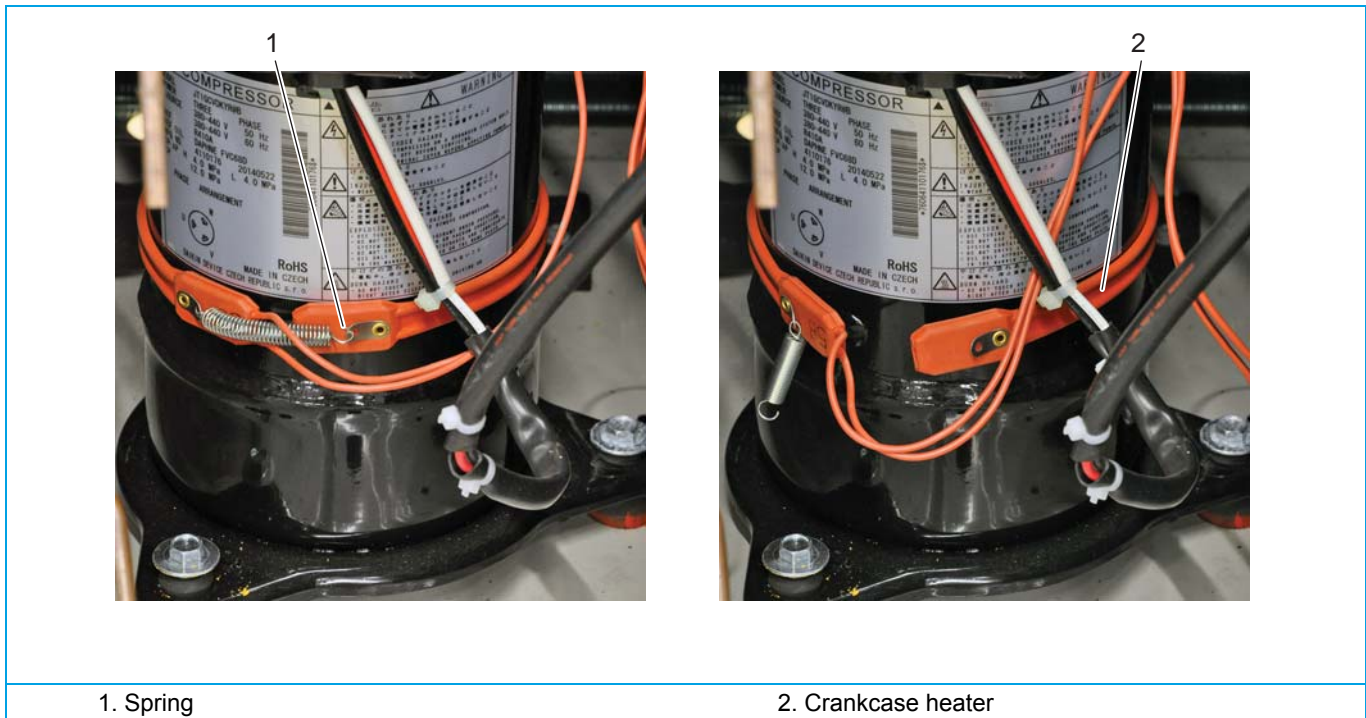

Installation



INFORMATION

Replace all tie wraps that were cut during removal.

1. Proceed in reverse order.

3.17. Replacing a reactor (L1R, L2R) (REMQ5T7Y1B, REYQ8~12T7Y1B)

Preliminary actions

1. Remove the upper front plate assembly, refer to ["Removing the upper front plate assembly" on page 101.](#)
2. Remove the front plate assembly, refer to ["Removing the front plate assembly" on page 102.](#)
3. Remove the switch box cover, refer to ["Removing the switch box cover" on page 103.](#)
4. Tilt the main and sub board assembly and the power terminal assembly, refer to ["Tilting the main and sub board assembly and the power terminal assembly \(REMQ5T7Y1B, REYQ8~12T7Y1B\)" on page 122.](#)

Procedure



INFORMATION

Depending on the model, the reactor wiring is plugged or screwed and a single or 2 reactors are installed.

The removal of a reactor is illustrated in ["Removing a reactor \(L1R, L2R L3R\)" on page 177.](#)

1. Remove the 4 screws (1) that fix the reactor (2).
2. Unplug the Faston plugs or loosen the wire terminals (3) and remove the wiring.
3. Remove the 2 screws (4) that fix the reactor (2).
4. Remove the reactor (2).

Figure 76 - Removing a reactor (L1R, L2R)

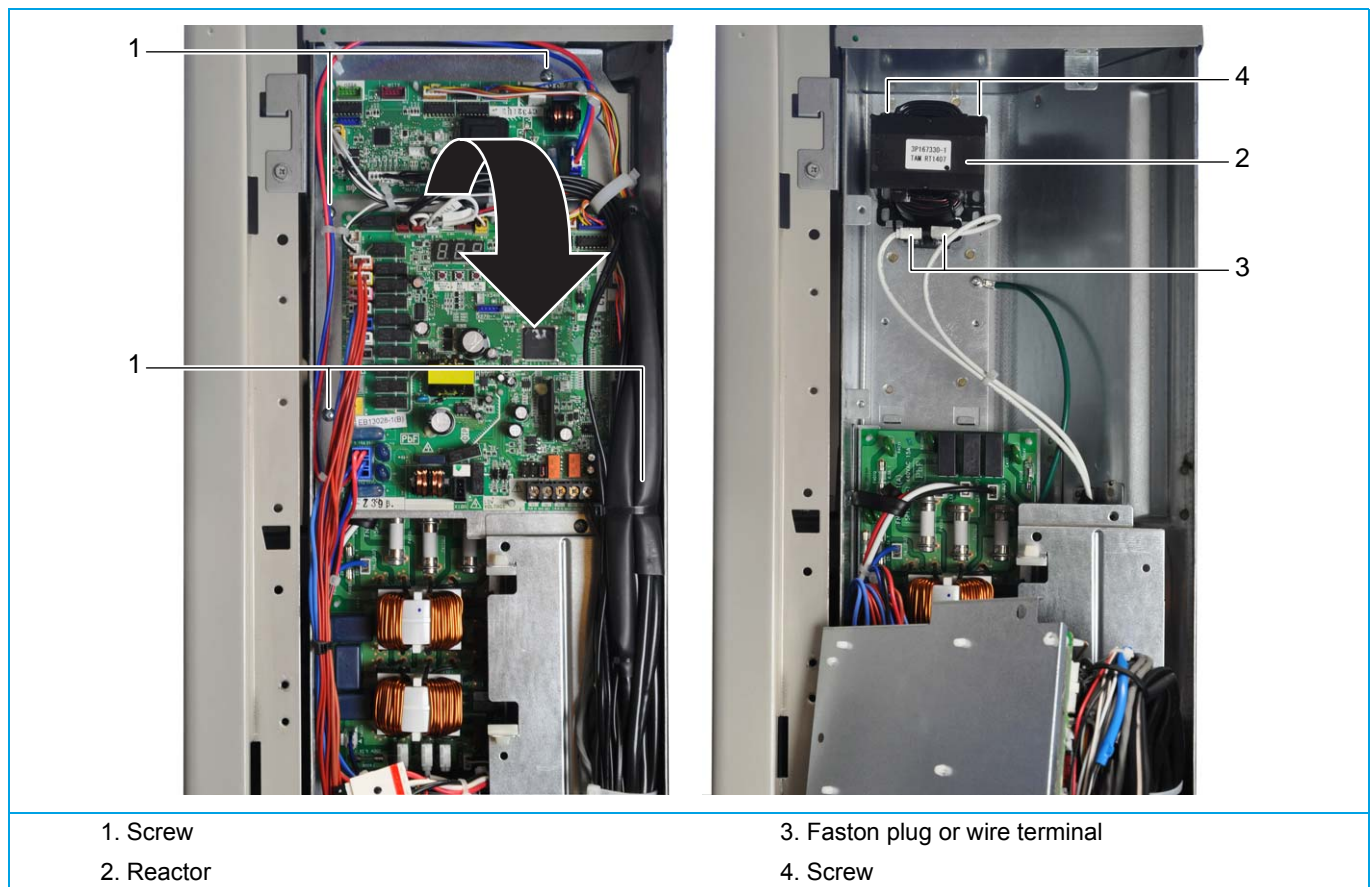

Installation

1. Proceed in reverse order.

Table 3-22: Reactor configuration overview (REMQ5T7Y1B, REYQ8~12T7Y1B)

Reactor	REMQ5T7Y1B	REYQ8Y1B	REYQ10Y1B	REYQ12Y1B
L1R	G	G	J	J
L2R	-	-	J	J

3.18. Replacing a reactor (L1R, L2R, L3R) (REYQ14~20T7Y1B)

Preliminary actions

1. Remove the upper front plate assembly, refer to "Removing the upper front plate assembly" on page 101.
2. Remove the front plate assembly, refer to "Removing the front plate assembly" on page 102.
3. Tilt the compressor inverter assembly, refer to "Tilting the inverter mounting plate (REYQ14~20T7Y1B)" on page 118.

Procedure



INFORMATION

Depending on the model, the reactor wiring is plugged or screwed and a 2 or 3 reactors are installed.

The removal of a reactor is illustrated in "Removing a reactor (L1R, L2R L3R)" on page 177.

1. Unplug the Faston plugs (4) or loosen the wire terminal (3) and remove the wiring.
2. Remove the 4 screws (5) that fix the reactor (1, 2).
3. Remove the reactor (1, 2).

Figure 77 - Removing a reactor (L1R, L2R L3R)

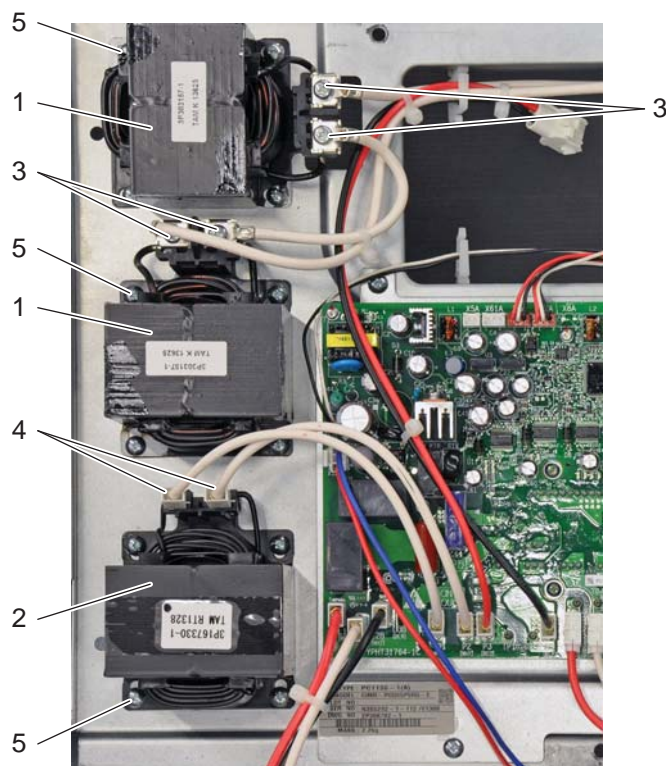

1. Reactor L2R, L3R
2. Reactor L1R
3. Wire terminal

4. Faston plug
5. Screw (x4)

Installation

1. Proceed in reverse order.

Table 3-23: Reactor configuration overview (REYQ14~20T7Y1B)

Reactor	REYQ14Y1B	REYQ16Y1B	REYQ18Y1B	REYQ20Y1B
L1R	G	G	G	G
L2R	G	G	J	J
L3R	-	-	J	J

3.19. Replacing the fan assembly

Preliminary actions



INFORMATION

Removing the bodywork includes removing:

- the upper front and upper side plate assemblies,
- the front plate assembly,
- the lower front plate assembly,
- the top plate assembly,
- the switch box cover.

1. Remove the bodywork, refer to "[Removing bodywork \(REMQ5T7Y1B, REYQ8~12T7Y1B\)](#)" on page 100 or "[Removing bodywork \(REYQ14~20T7Y1B\)](#)" on page 108.

Procedure REMQ5TY1B, REYQ8~12T7Y1B

1. Unplug the fan connectors X1A, X2A.
2. Cut all tie wraps that fix the fan wires.
3. Loosen and remove the screw (10) that fixes the cable clamp for the fan wiring.
4. Cut the tie 3 wraps (1) that fix the black wiring (2) below the switch box (2).
5. Loosen and remove the 2 screws (3) that fix the heat sink (5).
6. Loosen and remove the screw (6) that fixes the ground wire.
7. Loosen and remove the 3 screws (7) that fix the switch box (4).



INFORMATION

When removing the switch box, it is recommended to place a support in front of the outdoor unit.

The support will be used to temporarily hold the switch box.

The switch box weighs approximately 12 kg.

8. Place a support for the switch box in front of the outdoor unit.
9. Lift the switch box (4) over the heat pipe (5) and place the switch box (4) on the support.
10. Loosen and remove the screw (8) that fixes the fan assembly(9).

Figure 78 - Removing the fan assembly (REMQ5TY1B, REYQ8~12T7Y1B) - 1

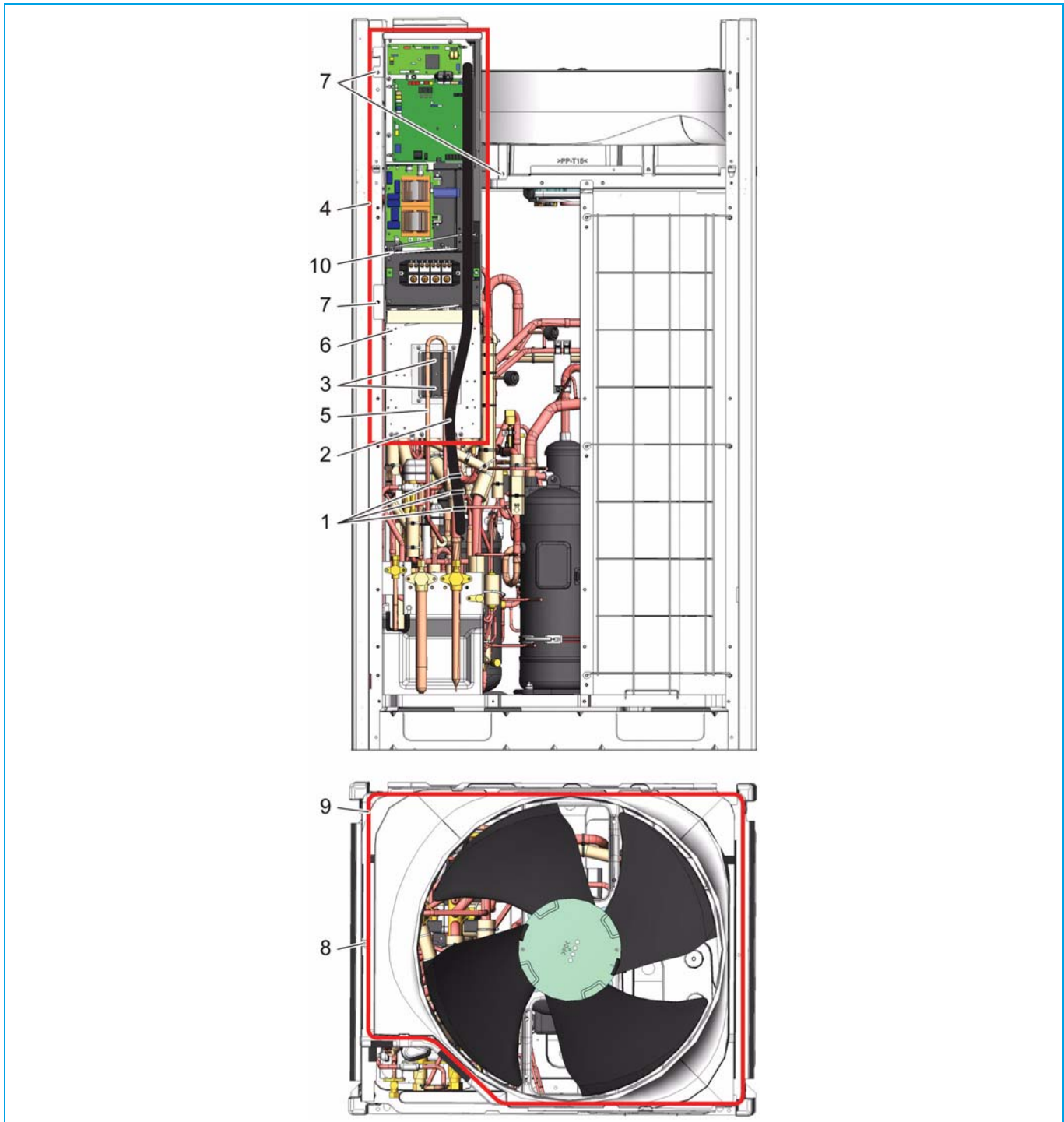

- | | |
|---------------|-----------------|
| 1. Tie wrap | 6. Screw |
| 2. Wiring | 7. Screw |
| 3. Screw | 8. Screw |
| 4. Switch box | 9. Fan assembly |
| 5. Heat sink | 10. Screw |

11. Loosen and remove the 3 screws (1) that fix the fan assembly (7) to the front right corner plate (2).
12. Loosen and remove the 3 screws (3) that fix the fan assembly (7) to the rear right corner plate (4).
13. Loosen and remove the 3 screws (5) that fix the fan assembly (7) to the rear left corner plate (6).
14. Loosen and remove the screw (10) that fixes the fan assembly (7) to the middle support plate (11).

15. Slightly lift the fan assembly (7) at the 3 corners while pulling the corner plate outwards to disengage the fan assembly fingers (8) from the corner plate's (2, 4, 6) slots (9).

Figure 79 - Removing the fan assembly (REMQ5TY1B, REYQ8~12T7Y1B) - 2

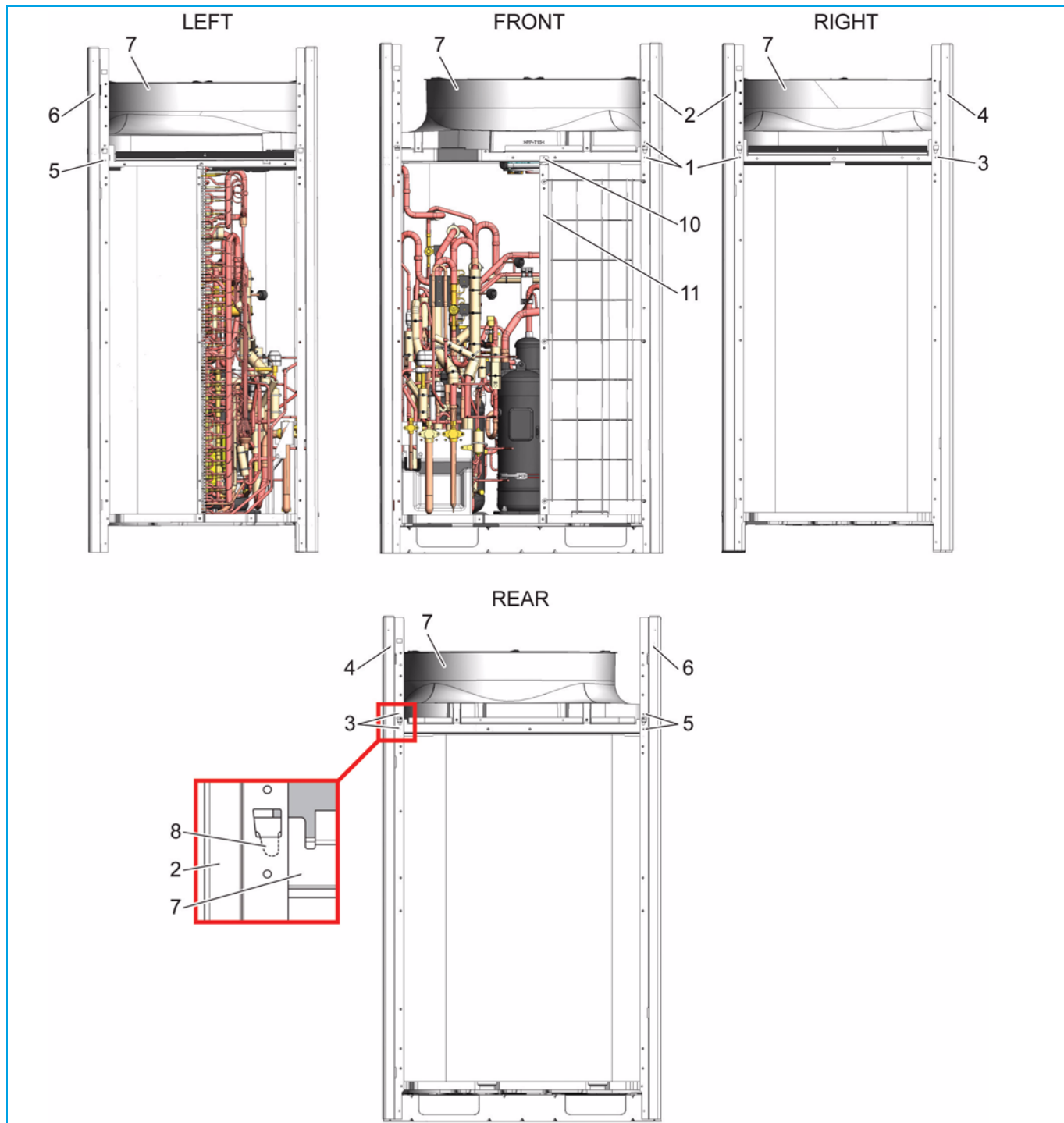

- | | |
|-------------------------------------|--------------------------|
| 1. Screw | 7. Fan assembly |
| 2. Front right corner support plate | 8. Finger |
| 3. Screw | 9. Slot |
| 4. Rear right corner support plate | 10. Screw |
| 5. Screw | 11. Middle support plate |
| 6. Rear left corner support plate | |

16. Loosen and remove the 3 screws (1) that fix the rear right corner plate (2) to the rear installation leg (3) and bottom plate (6).
17. Lift the rear right corner plate (2) and remove it.
18. Loosen and remove the 3 screws (4) that fix the rear left corner plate (5) to the rear installation leg (3) and bottom plate (6).
19. Lift the rear left corner plate (5) and remove it.

	<p>WARNING</p> <p>Two persons are required to remove/install the fan assembly (approximate weight = 21 kg).</p>
-----------------------------------------------------------------------------------	------------------------------------------------------------------------------------------------------------------------

	<p>CAUTION</p> <p>Check that the fan assembly wire is not entangled.</p>
-----------------------------------------------------------------------------------	---------------------------------------------------------------------------------

20. From the rear of the VRV4 outdoor unit, lift and remove the fan assembly (7).

Figure 80 - Removing the fan assembly (REMQ5TY1B, REYQ8~12T7Y1B) - 3

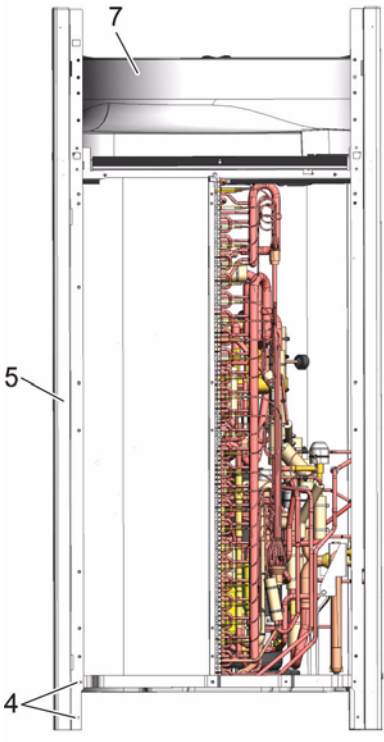
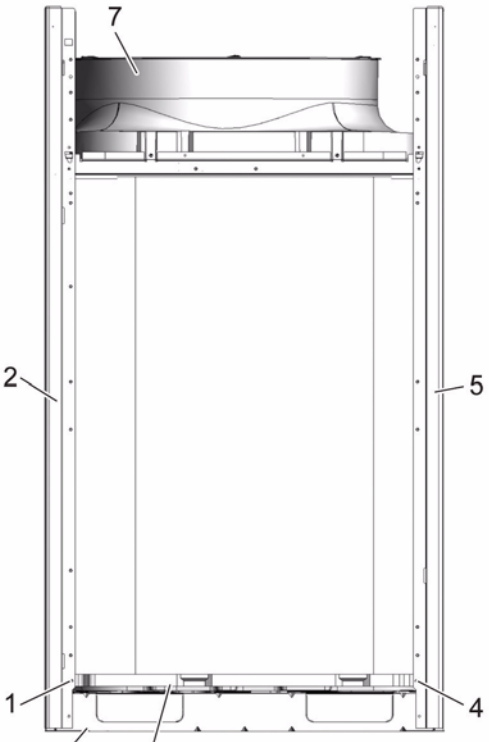
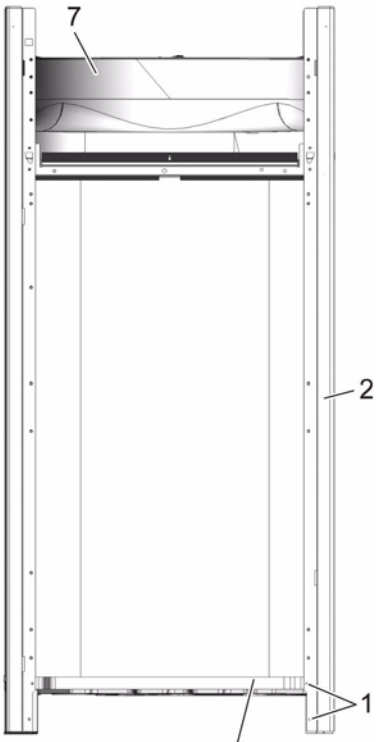
<p>LEFT</p> 	<p>REAR</p> 	<p>RIGHT</p> 
<p>1. Screw</p> <p>2. Rear right corner support plate</p> <p>3. Rear installation leg</p> <p>4. Screw</p>	<p>5. Rear left corner support plate</p> <p>6. Bottom plate</p> <p>7. Fan assembly</p>	

Procedure REYQ14~20T7Y1B

1. Unplug the fan connectors X1A, X2A, X3A, X4A.
2. Cut all tie wraps that fix the fan wires.
3. Cut the tie 2 wraps (1) that fix the black wiring (2) below the switch box (5).
4. Loosen and remove the screw (3) that fixes the RT1 support.
5. Loosen and remove the 4 screws (6) that fix the heat sinks (6).
6. Loosen and remove the short screw (4) that fixes the grounding wire to the heat sinks (6).
7. Loosen and remove the 4 screws (8) that fix the switch box (5).
8. Unplug 8 connectors (9) from the A1P board.

**INFORMATION**

When removing the switch box, it is recommended to place a support in front of the outdoor unit.
The support will be used to temporarily hold the switch box.
The switch box weighs approximately 16 kg.

9. Place a support for the switch box in front of the outdoor unit.
10. Lift the switch box (5) over the heat sinks (6) and place the switch box (5) on the support.
11. Loosen and remove the screw (10) that fixes the fan assembly(11).

Figure 81 - Removing the fan assembly (REYQ14~20T7Y1B) - 1

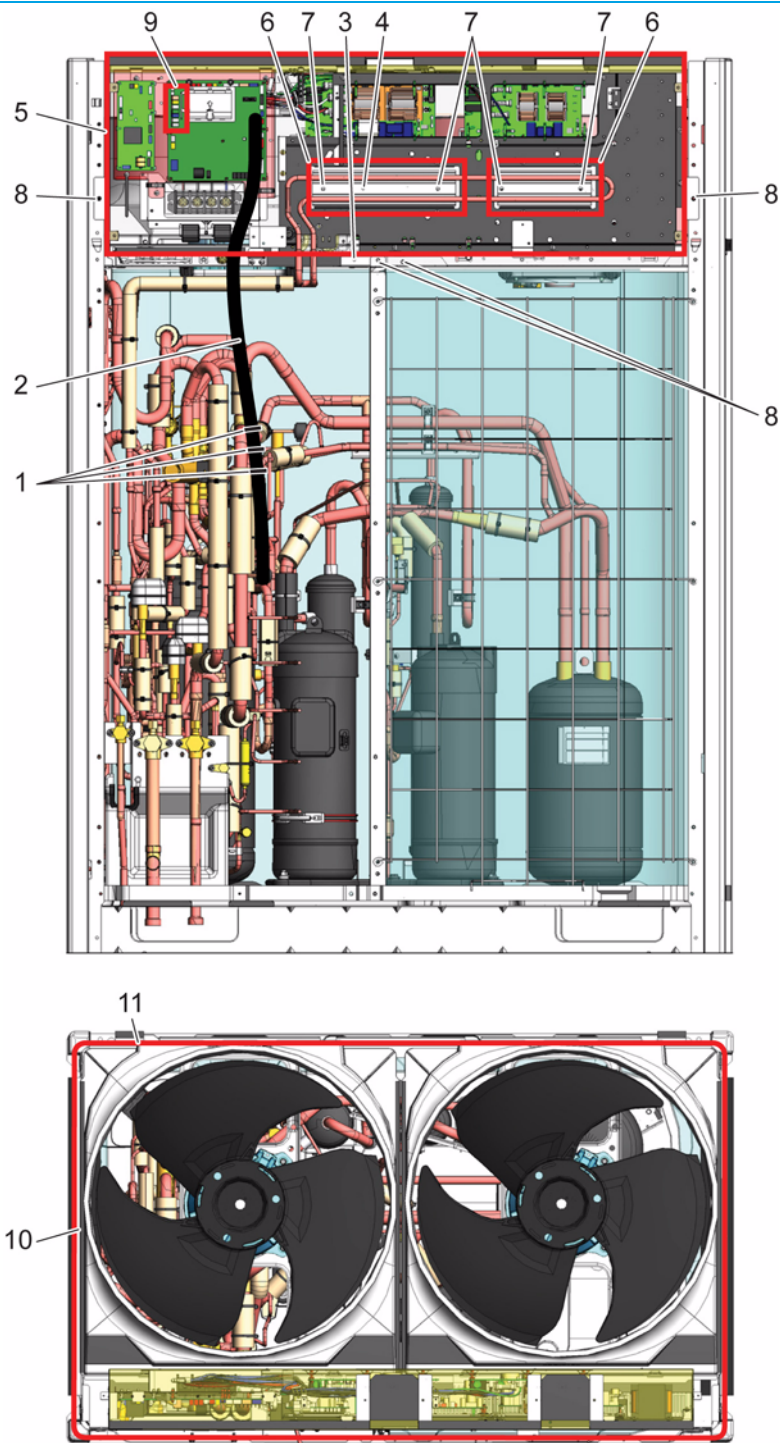

- | | |
|----------------|------------------|
| 1. Tie wrap | 7. Screw |
| 2. Wiring | 8. Screw |
| 3. Screw | 9. Connector |
| 4. Short screw | 10. Screw |
| 5. Switch box | 11. Fan assembly |
| 6. Heat sink | |

12. Loosen and remove the 3 screws (1) that fix the fan assembly (9) to the front right corner plate (2).
13. Loosen and remove the 3 screws (3) that fix the fan assembly (9) to the front left corner plate (4).
14. Loosen and remove the 3 screws (5) that fix the fan assembly (9) to the rear right corner plate (6).

15. Loosen and remove the 3 screws (7) that fix the fan assembly (9) to the rear left corner plate (8).
16. Loosen and remove the screw (10) that fixes the fan assembly (9) to the middle support plate (13).
17. Slightly lift the fan assembly (9) at the 4 corners while pulling the corner plate outwards to disengage the fan assembly fingers (11) from the corner plate's (2, 4, 6, 8) slots (12).

Figure 82 - Removing the fan assembly (REYQ14~20T7Y1B) - 2

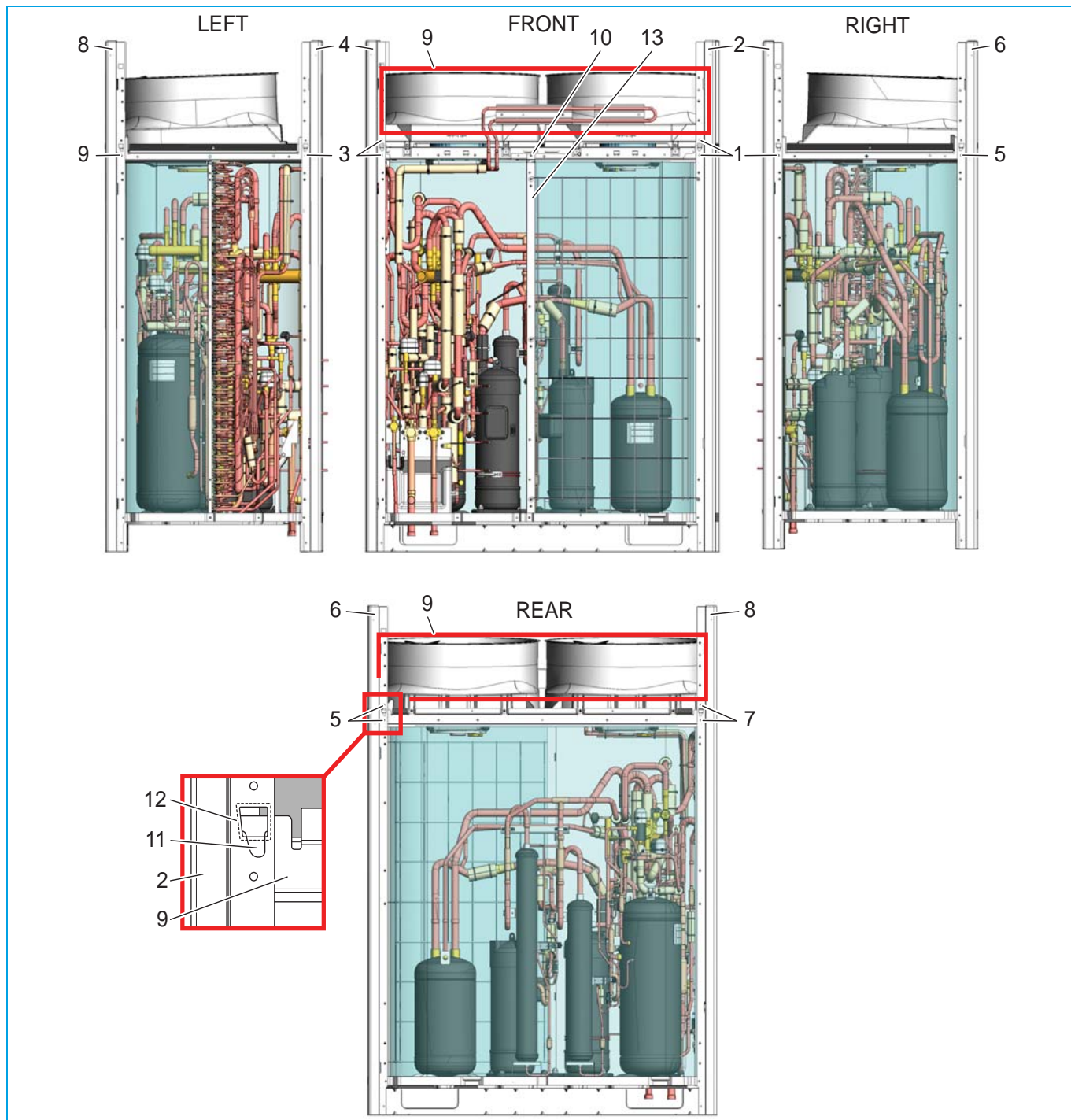

- | | |
|-------------------------------------|-----------------------------------|
| 1. Screw | 8. Rear left corner support plate |
| 2. Front right corner support plate | 9. Fan assembly |
| 3. Screw | 10. Screw |
| 4. Front left corner support plate | 11. Finger |
| 5. Screw | 12. Slot |
| 6. Rear right corner support plate | 13. Middle support plate |
| 7. Screw | |

18. Loosen and remove the 3 screws (1) that fix the rear right corner plate (2) to the rear installation leg (3) and bottom plate (6).
19. Lift the rear right corner plate (2) and remove it.
20. Loosen and remove the 3 screws (4) that fix the rear left corner plate (5) to the rear installation leg (3) and bottom plate (6).
21. Lift the rear left corner support plate (5) and remove it.



WARNING

Two persons are required to remove/install the fan assembly (approximate weight = 33 kg).



CAUTION

Check that the fan assembly wires are not entangled.

22. From the rear of the VRV4 outdoor unit, lift and remove the fan assembly (7).

Figure 83 - Removing the fan assembly (REYQ14~20T7Y1B) - 3

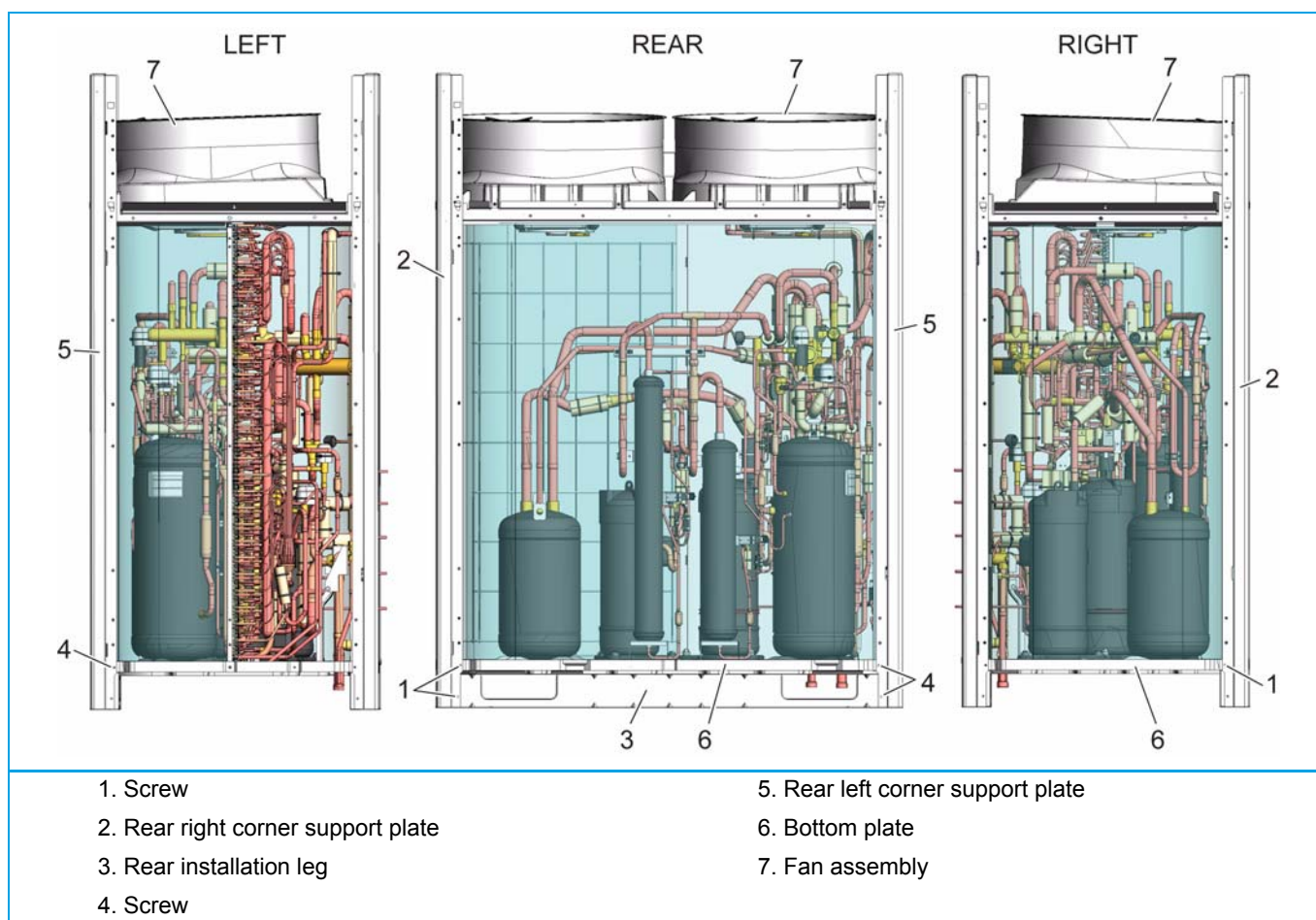

Installation



INFORMATION

Replace all tie wraps that were cut during removal.

1. Proceed in reverse order.

3.20. Replacing the heat exchanger

Preliminary actions

1. Remove the fan assembly, refer to ["Replacing the fan assembly" on page 179](#).
2. Recover the refrigerant, refer to ["Refrigerant Handling" on page 95](#).
3. Connect a nitrogen hose (2) to the outdoor suction service port (1) (middle service port).
4. Attach a hose with core-depressor (4) to allow the release of the nitrogen.
 - If Y4S or Y5S is in the off condition (outdoor upper respectively middle heat-exchanger is condenser), attach a hose (4) to the outdoor liquid service port (3) (left service port).
 - If Y4S and Y5S are in the on condition (outdoor upper and middle heat-exchanger are evaporator), attach a hose (4) to the HP/LP service port (8) (right service port).

Procedure REMQ5TY1B, REYQ8~12T7Y1B

1. Loosen and remove the 3 screws (1) that fix the suction grille (2) to the front right corner plate (3).
2. Loosen and remove the 3 screws (4) that fix the suction grille (2) to the middle support plate (5).
3. Remove the suction grille (2).
4. Loosen and remove the 3 screws (6) that fix the front right corner plate (3) to the front installation leg (7) and bottom plate (8).
5. Lift the front right corner plate (3) and remove it.
6. Loosen and remove the 3 screws (9) that fix the front left corner plate (10) to the front installation leg (7) and bottom plate (8).
7. Lift the front left corner plate (10) and remove it.
8. Loosen and remove the screw (11) that fixes the middle support plate (5) to the front installation leg (7).

Figure 84 - Removing the heat exchanger (REMQ5TY1B, REYQ8~12T7Y1B) - 1

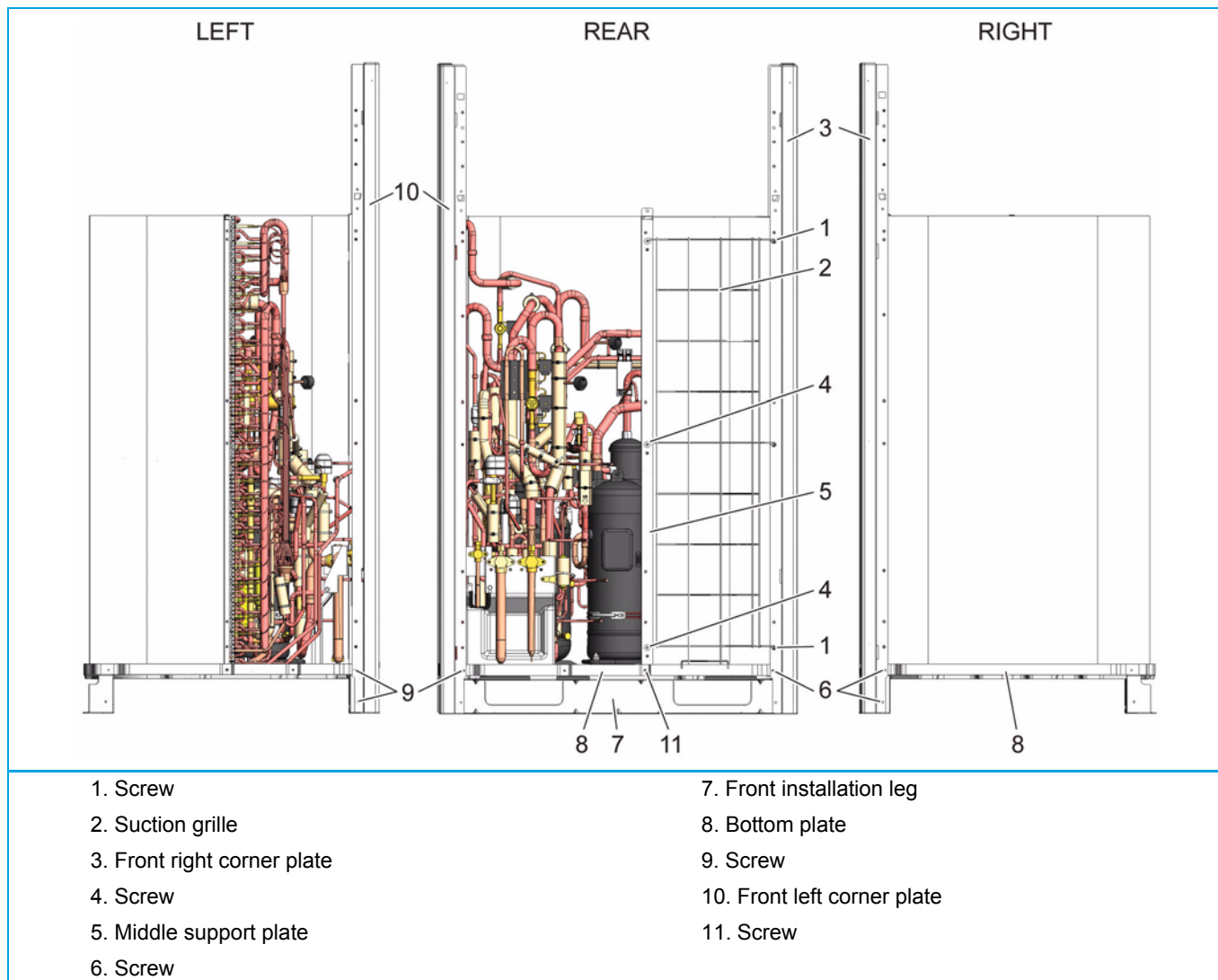

9. Remove thermistor R11T (4), refer to ["Replacing a thermistor" on page 145](#).
10. Supply nitrogen to the piping circuit.
11. Using an oxygen acetylene torch, heat and disconnect the 2 gas pipes (1).
12. Using an oxygen acetylene torch, heat and disconnect the 2 liquid pipes (2).
13. Using an oxygen acetylene torch, heat and disconnect the 2 liquid pipes (3).
14. Cut the nitrogen supply when the piping has cooled down.

Figure 85 - Removing the heat exchanger (REMQ5TY1B, REYQ8~12T7Y1B) - 2

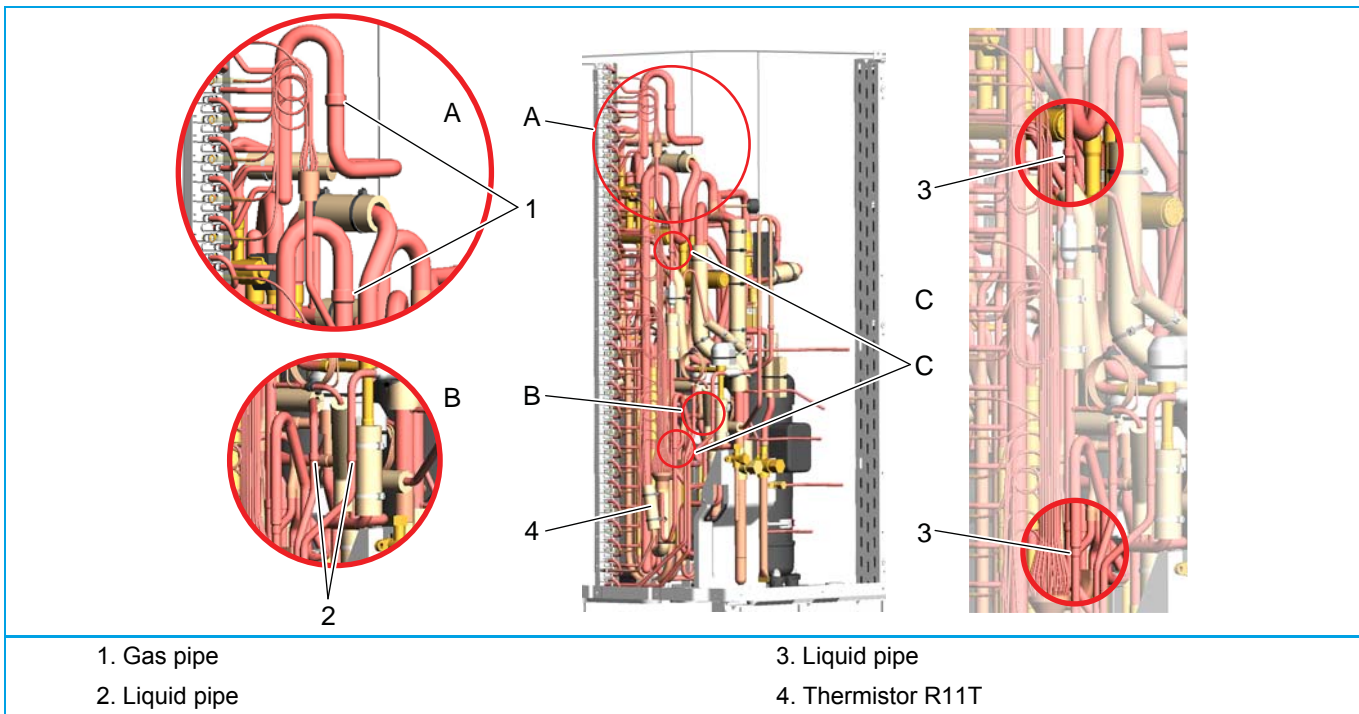

WARNING

Two persons are required to remove/install the heat exchanger (approximate weight = 37 kg).

15. Lift the heat exchanger (1) and the middle support plate (2) from the bottom plate (3) and remove both from the outdoor unit.

Figure 86 - Removing the heat exchanger (REMQ5TY1B, REYQ8~12T7Y1B) - 3

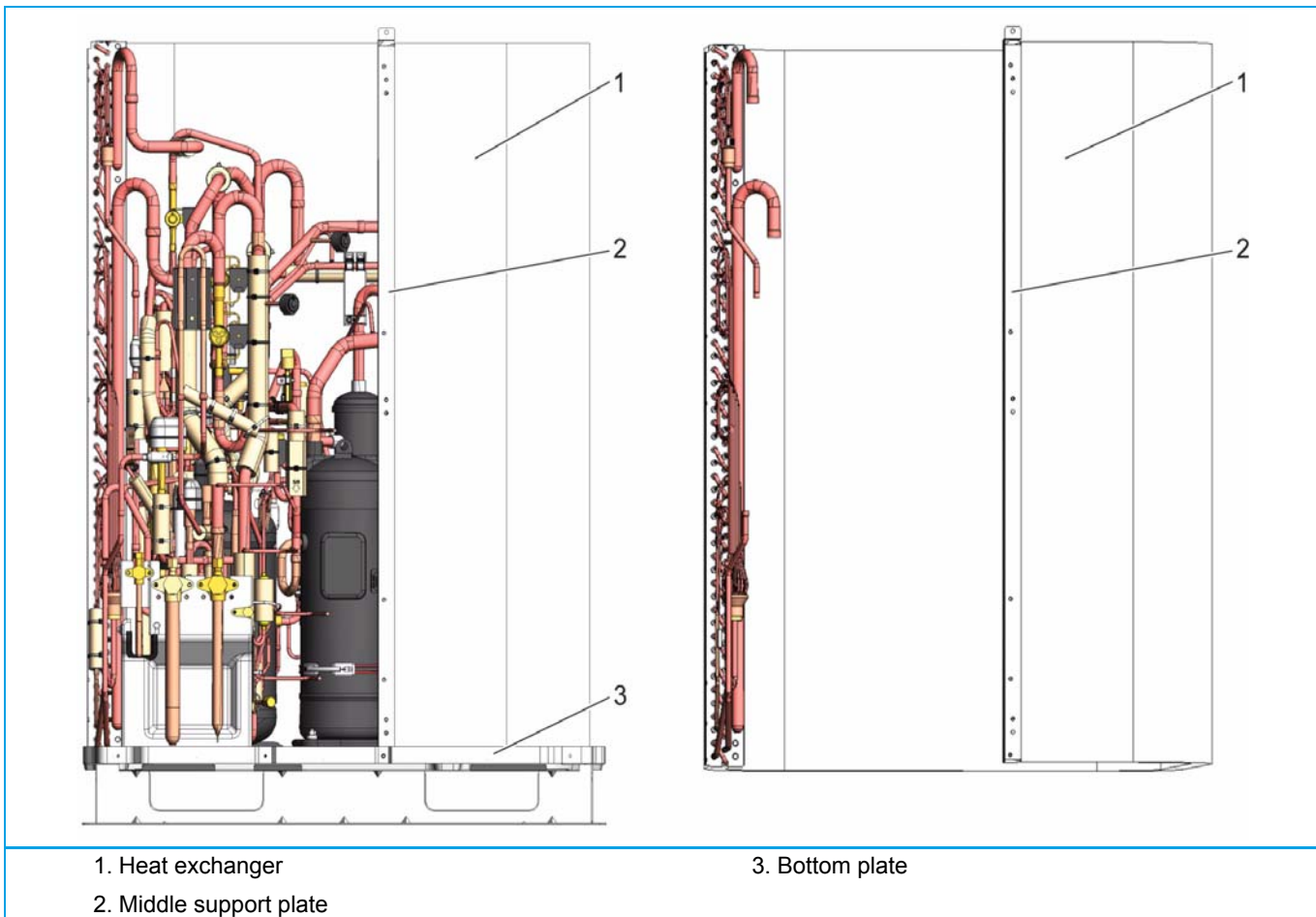

16. Loosen and remove the 3 screws (1) that fix the middle support plate (2) to the heat exchanger (3).
17. Separate the middle support plate (2) and the heat exchanger (3).

Figure 87 - Removing the heat exchanger (REMQ5TY1B, REYQ8~12T7Y1B) - 4

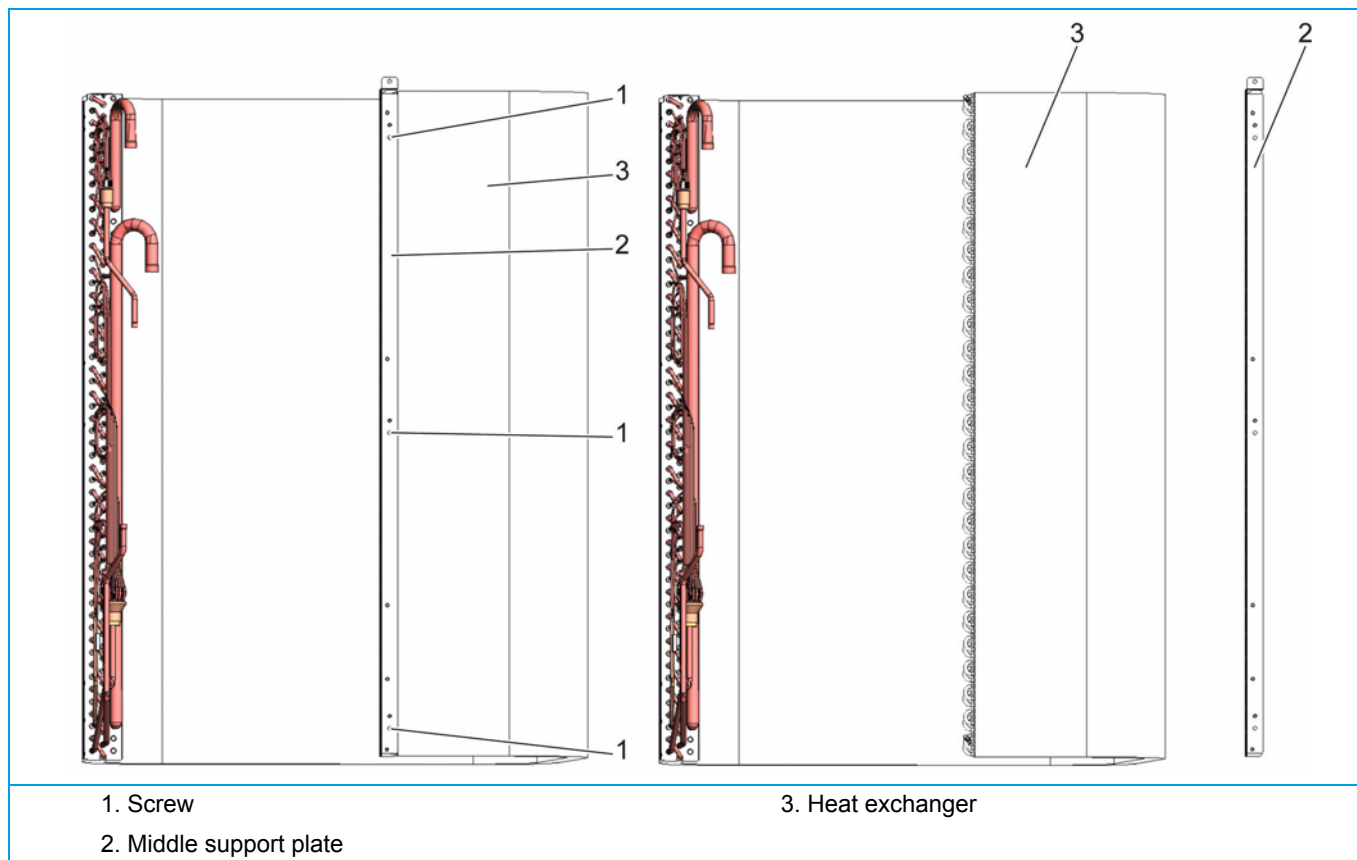

Installation

Proceed in reverse order.

Procedure REYQ14~20T7Y1B

1. Loosen and remove the 3 screws (1) that fix the suction grille (2) to the front right corner plate (3).
2. Loosen and remove the 3 screws (4) that fix the suction grille (2) to the middle support plate (5).
3. Remove the suction grille (2).
4. Loosen and remove the 3 screws (6) that fix the front right corner plate (3) to the front installation leg (7) and bottom plate (8).
5. Lift the front right corner plate (3) and remove it.
6. Loosen and remove the 3 screws (9) that fix the front left corner plate (10) to the front installation leg (7) and bottom plate (8).
7. Lift the front left corner plate (10) and remove it.
8. Loosen and remove the screw (11) that fixes the middle support plate (5) to the front installation leg (7).

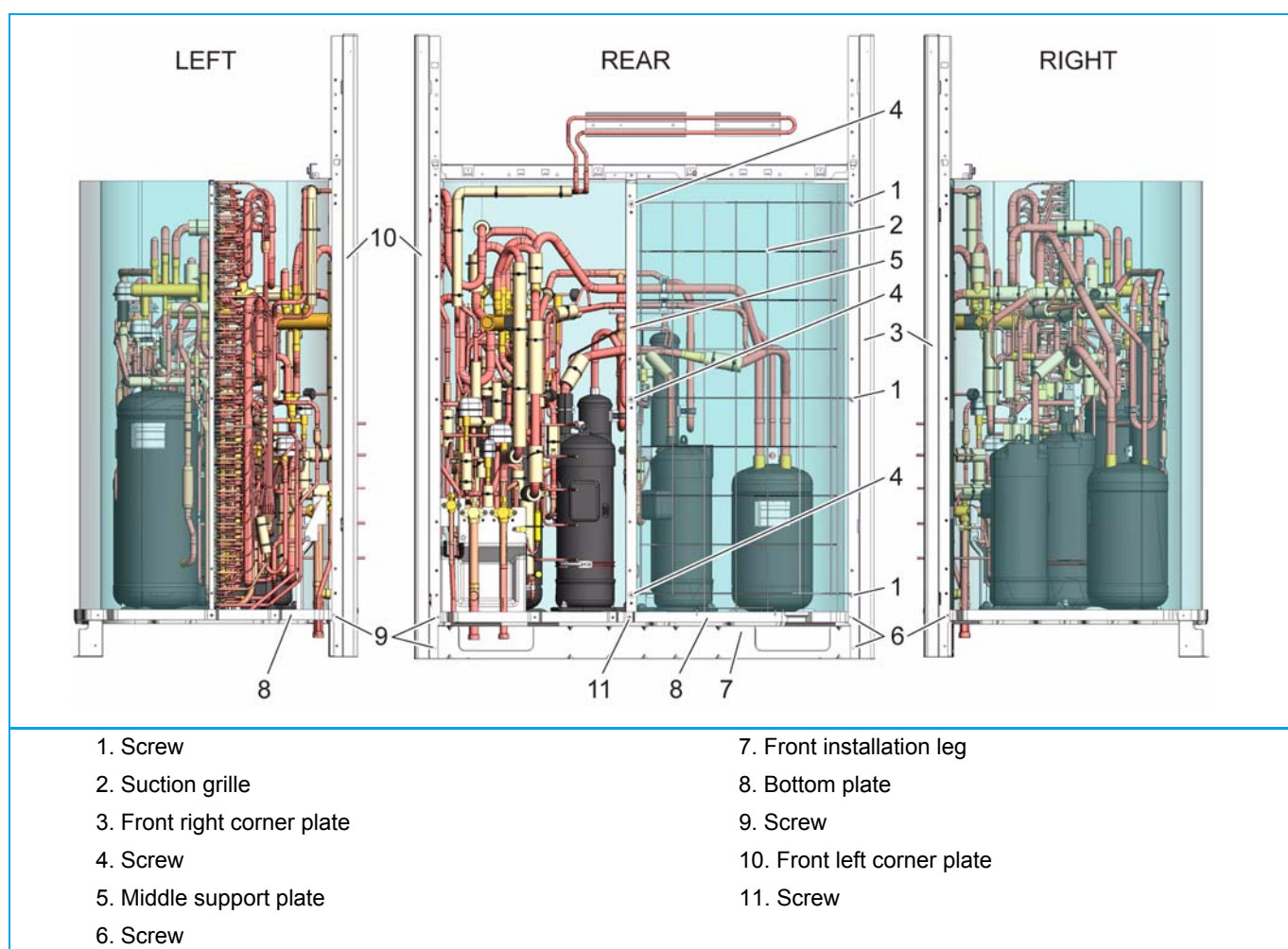
Figure 88 - Removing the heat exchanger (REYQ14~20T7Y1B) - 1

9. Remove thermistor R11T (4), refer to ["Replacing a thermistor" on page 145](#).
10. Supply nitrogen to the piping circuit.
11. Using an oxygen acetylene torch, heat and disconnect the 2 gas pipes (1).
12. Using an oxygen acetylene torch, heat and disconnect the 2 liquid pipes (2).
13. Using an oxygen acetylene torch, heat and disconnect the 2 liquid pipes (3).
14. Cut the nitrogen supply when the piping has cooled down.

Figure 89 - Removing the heat exchanger (REYQ14~20T7Y1B) - 2

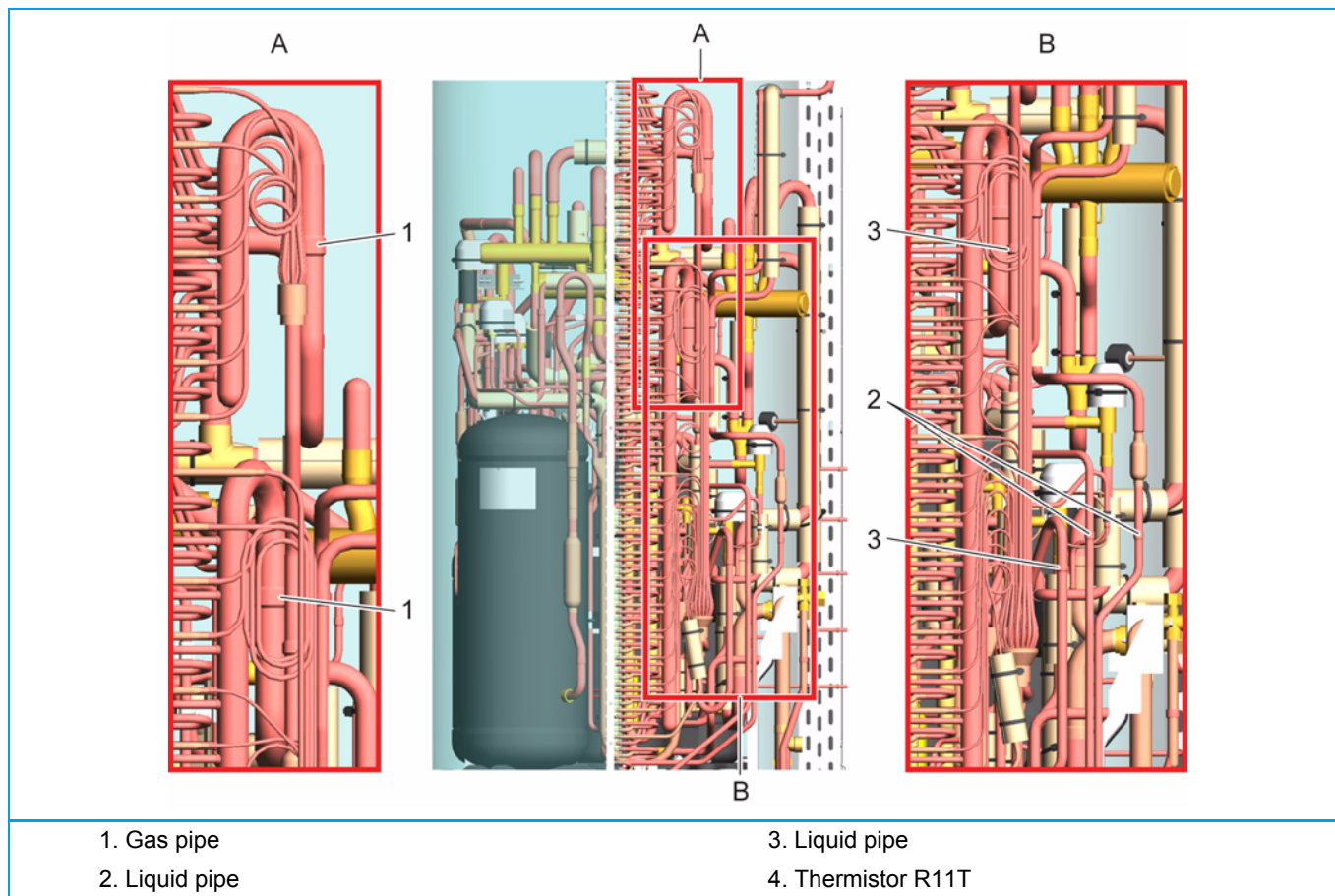

WARNING

Two persons are required to remove/install the heat exchanger (approximate weight = 42 kg).

15. Move the rear side of the heat exchanger (1) towards the rear, then move the heat exchanger towards the right until the middle support plate (2) is beyond the accumulator; finally move the heat exchanger and middle support plate (2) towards the rear to remove both from the outdoor unit.

Figure 90 - Removing the heat exchanger (REYQ14~20T7Y1B) - 3

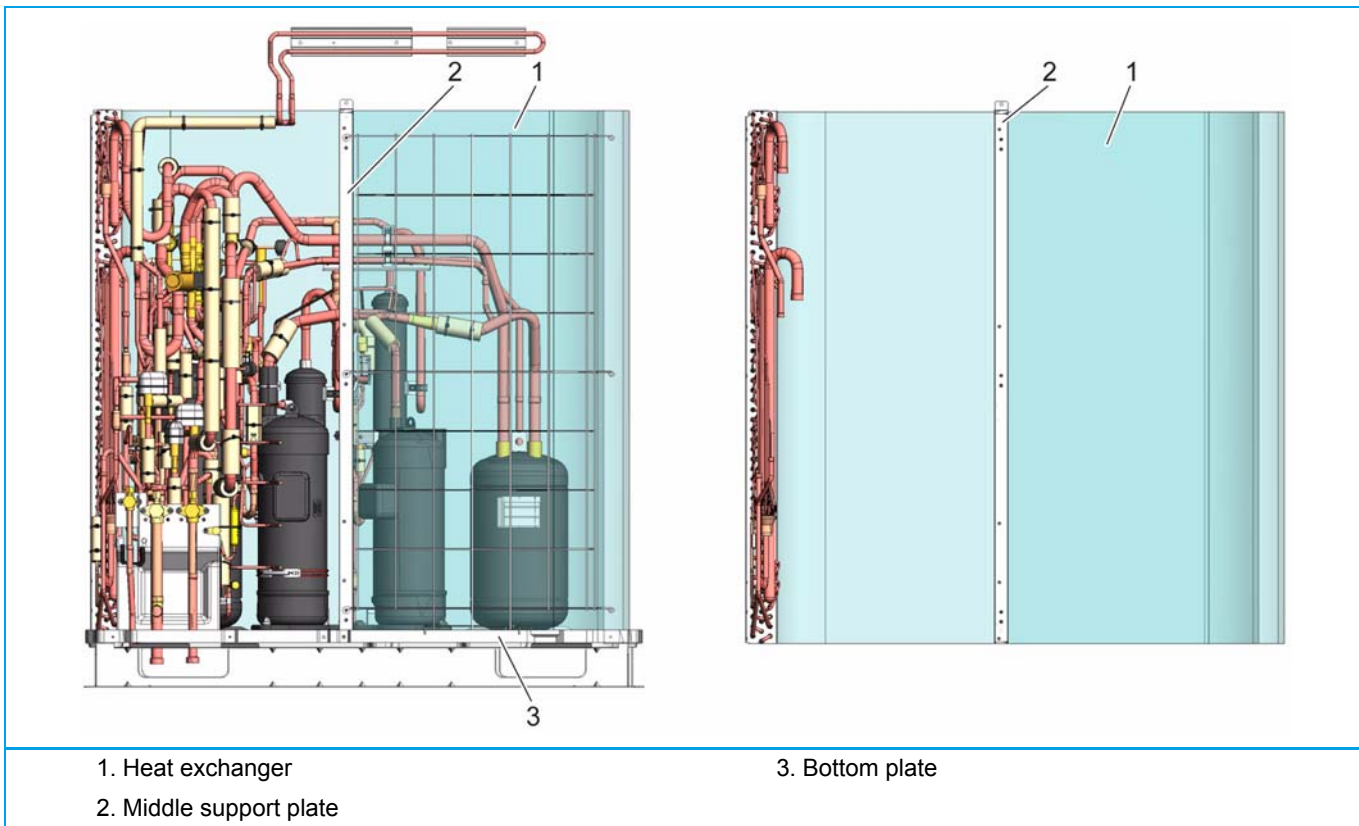

16. Loosen and remove the 3 screws (1) that fix the middle support plate (2) to the heat exchanger (3).

17. Separate the middle support plate (2) and the heat exchanger (1).

Figure 91 - Removing the heat exchanger (REYQ14~20T7Y1B) - 4

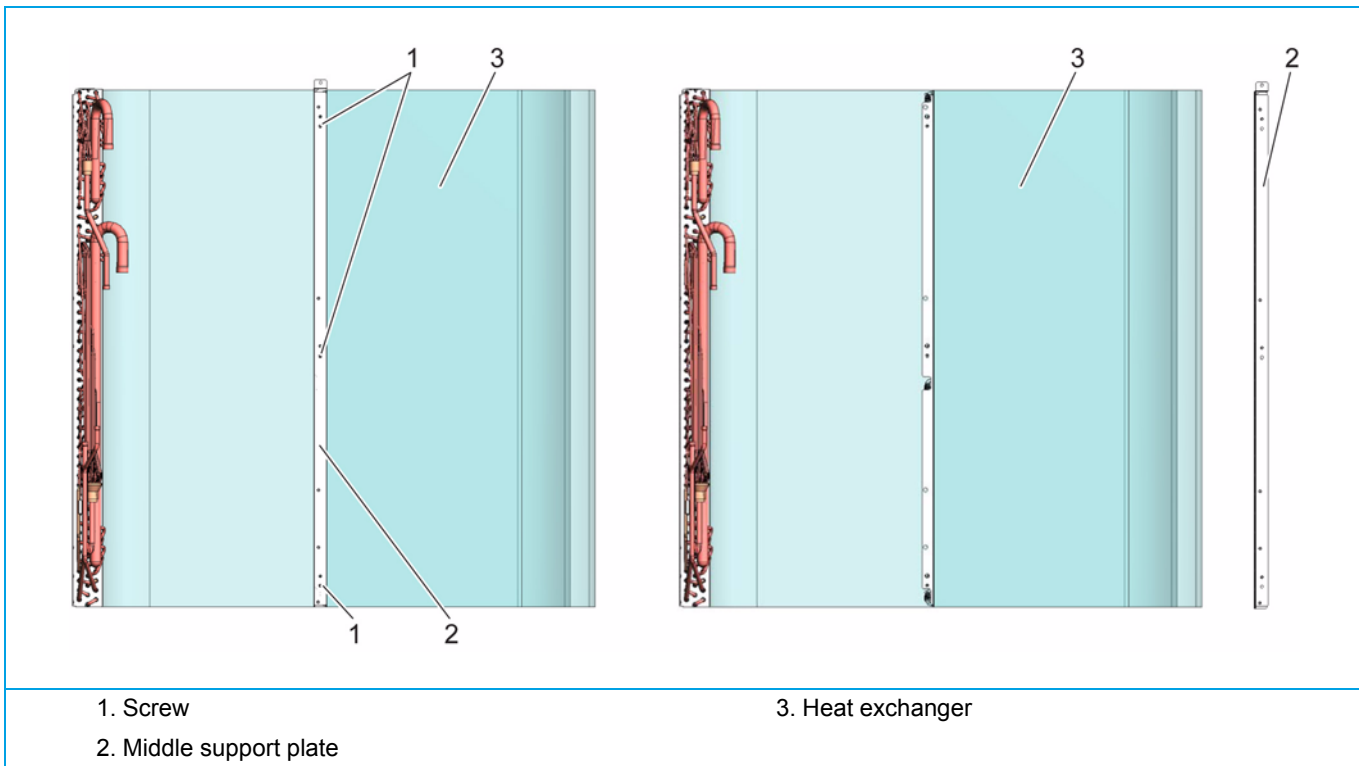

Installation

Proceed in reverse order.

3.21. Replacing a control board in the BS unit

Preliminary actions

1. Remove the BS unit cover, refer to "Removing the BS unit cover" on page 116.

Procedure

The position of the control board is illustrated "Displacing a bracket" on page 124.

1. Unplug all connectors from the BS unit control board (1).
2. Carefully pull the BS unit control board (1) at the side and unlatch the 6 pcb supports (2) one by one using a small pliers, see §2.8.

Figure 92 - Replacement of the BS unit control board

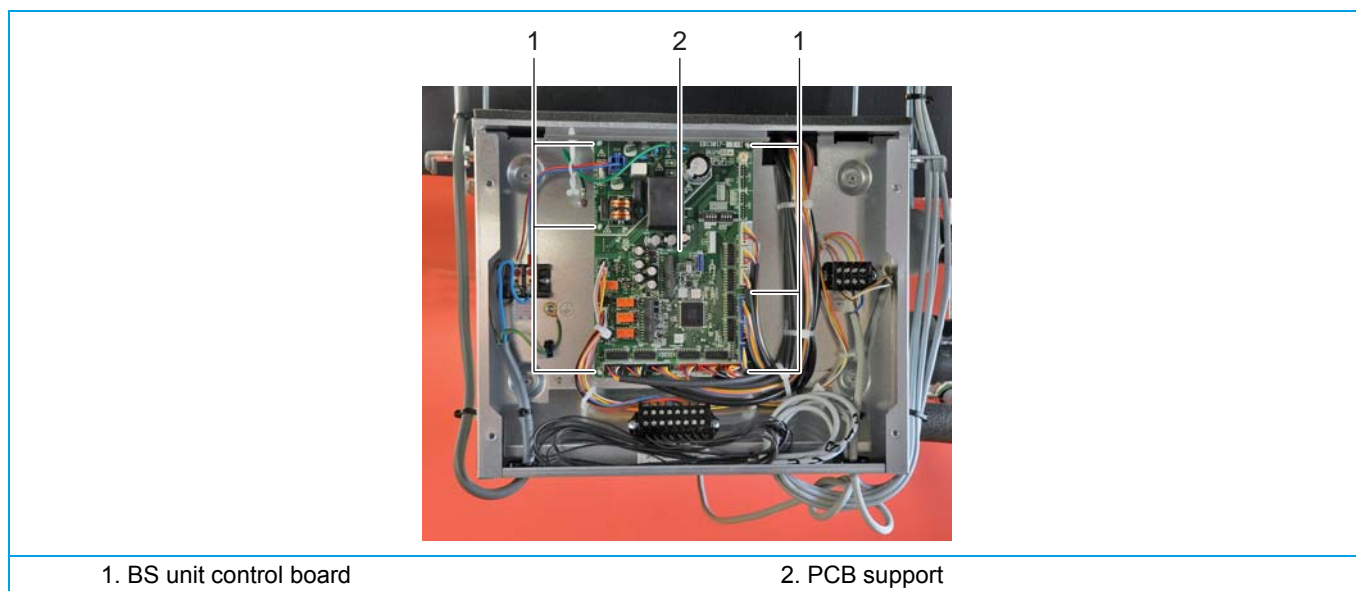

Installation



INFORMATION

Replace all tie wraps that were cut during removal.

1. Proceed in reverse order.

Part 4. Maintenance

1. VRV indoor unit

1.1 Safety



WARNING

Before performing any maintenance, power off the unit.

Before carrying out any maintenance or repair activity, always switch off the circuit breaker on the supply panel, remove the fuses or open the protection devices of the unit.

Make sure that before starting any maintenance or repair activity, also the power supply to the outdoor unit is switched off.

Before carrying out any maintenance or repair activity, always switch off the multi tenant power supply.

Do not touch live parts for 10 minutes after the power supply is turned off because of high voltage risk.

Additionally, measure the points as shown in the figure below with a tester and confirm that the voltage of the capacitor in the main circuit is no more than 50 V DC.

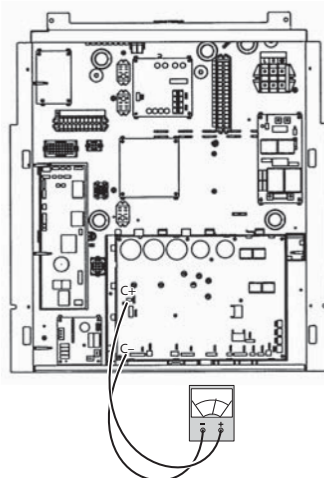

Switch box
HXHD125A7V1

Please note that some sections of the electric component box are hot.

Make sure you do not touch a conductive section.

Do not rinse the indoor unit. This may cause electric shocks or fire.



CAUTION

Play it safe!

Touch a metal part by hand (such as the stop valve) in order to eliminate static electricity and to protect the PCB before performing service.



IMPORTANT INFORMATION REGARDING THE REFRIGERANT USED

This product contains fluorinated greenhouse gases covered by the Kyoto Protocol. Do not vent gases into the atmosphere.

Refrigerant type:

R134a (water circuit), GWP(1) value: 1300

R410A (outdoor), GWP(1) value: 1975

(1) GWP = global warming potential



IMPORTANT INFORMATION REGARDING THE REFRIGERANT USED

National implementation of EU regulation on certain fluorinated greenhouse gases may require to provide the appropriate official national language on the unit.

Therefore, an additional multilingual fluorinated greenhouse gases label is supplied with the unit.

Sticking instructions are illustrated on the backside of that label.

1.2. Maintenance procedures

In order to ensure optimal availability of the unit, a number of checks and inspections on the unit and the field wiring have to be carried out at regular intervals.

This maintenance should be carried out by your local installer. To execute the maintenance activities as mentioned below, it is only required to remove the front decoration panel.

To take away the front decoration panel, remove the 2 bottom screws and then unhitch the panel.

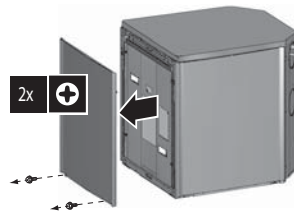

Following items should be checked on the product at least once a year:

The described checks must be executed at least once a year by qualified personnel.

1. Pressure relief valve hose
Check that the pressure relief valve hose is positioned appropriately to drain the water.
2. Water pressure relief valve
Check for correct operation of the pressure relief valve by turning the red knob on the valve counter-clockwise:
 - If you do not hear a clacking sound, contact your local dealer.
 - In case the water keeps running out of the unit, close both the water inlet and outlet shut-off valves first and then contact your local dealer.
3. Indoor unit switch box
Carry out a thorough visual inspection of the switch box and look for obvious defects such as loose connections or defective wiring.
4. Water pressure
Check if the water pressure is above 1 bar.
If necessary add water.
5. Water filter
Clean the water filter.

2. HXY080+125A7V1B VRV IV System indoor unit

2.1 Safety



IMPORTANT INFORMATION REGARDING THE REFRIGERANT USED

This product contains fluorinated greenhouse gases covered by the Kyoto Protocol. Do not vent gases into the atmosphere.

Refrigerant type: R410A

GWP(1) value: 1975

(1) GWP = global warming potential

Periodical inspections for refrigerant leaks may be required depending on the applicable legislation. Please contact your local dealer for more information.

2.2. Maintenance

In order to ensure optimal readiness of the unit, a number of checks and inspections on the unit and the field wiring have to be carried out

at regular intervals, preferably yearly. This maintenance should be carried out by your local Daikin technician (see installation manual).

The only maintenance which may be required by the operator is:

- Keeping the user interface clean by means of a soft damp cloth.
- Checking if the water pressure indicated on the manometer is above 1 bar.



WARNING

If the supply cord is damaged, it must be replaced by the manufacturer, its agent or similar qualified persons in order to avoid hazards.

3. REYQ8~20+REMQ5T7Y1B VRV IV system air conditioner

3.1. Safety



WARNING

RISK OF ELECTROCUTION.

When performing service to inverter equipment:

1. Do not open the electrical component box cover for 10 minutes after the power supply is turned off.
2. Measure the voltage between terminals on the terminal block for power supply with a tester and confirm that the power supply is shut off. In addition, check that the voltage of the capacitor in the main circuit is less than 50 V DC, "[Checking the rectifier voltage](#)" on page 117.
3. Pull out junction connectors X1A, X2A (X3A, X4A) for the fan motors in the outdoor unit before starting service operation on the inverter equipment. Be careful not to touch the live parts. (If a fan rotates due to strong wind, it may store electricity in the capacitor or in the main circuit and cause electric shock.)
4. After the service is finished, plug the junction connector back in. Otherwise the malfunction code *E7* will be displayed on the user interface or on the outdoor unit 7segment display and normal operation will not be performed.



WARNING

The refrigerant in the air conditioner is safe and normally does not leak. If the refrigerant leaks in the room, contact with a fire of a burner, a heater or a cooker may result in a harmful gas.

Turn off any combustible heating devices, ventilate the room and contact the dealer where you purchased the unit.

Do not use the air conditioner until a service person confirms that the portion where the refrigerant leaks is repaired.



WARNING

- Do not modify, disassemble, remove, reinstall or repair the unit yourself as incorrect dismantling or installation may cause an electric shock or fire. Contact your dealer.
- In case of accidental refrigerant leaks, make sure there are no naked flames. The refrigerant itself is entirely safe, nontoxic and noncombustible, but it will generate toxic gas when it accidentally leaks into a room where combustible air from fan heaters, gas cookers, etc. is present. Always have qualified service personnel confirm that the point of leakage has been repaired or corrected before resuming operation



WARNING

RISK OF BURNING.



WARNING

Pay attention to the fan. It is dangerous to inspect the unit while the fan is running. Make sure to turn off the main switch and to remove the fuses from the control circuit located in the outdoor unit.



WARNING

After a long use, check the unit stand and fitting for damage. If damaged, the unit may fall and result in injury.



CAUTION

Do not insert fingers, rods or other objects into the air inlet or outlet. Do not remove the fan guard. When the fan is rotating at high speed, it will cause injury.

**CAUTION**

Pay attention to the fan.
It is dangerous to inspect the unit while the fan is running. Be sure to turn off the main switch before executing any maintenance task.

**CAUTION**

Do not wipe the controller operation panel with benzine, thinner, chemical dust cloth, etc. The panel may get discoloured or the coating peeled off. If it is heavily dirty, soak a cloth in waterdiluted neutral detergent, squeeze it well and wipe the panel clean. Wipe it with another dry cloth.

**INFORMATION**

Maintenance should preferably be carried out yearly by an installer or service agent.

**IMPORTANT INFORMATION REGARDING THE REFRIGERANT USED**

This product contains fluorinated greenhouse gases covered by the Kyoto Protocol. Do not vent gases into the atmosphere.

Refrigerant type: R410A

GWP(1) value: 1975

(1) GWP = global warming potential

Periodical inspections for refrigerant leaks may be required depending on the applicable legislation. Please contact your installer for more information.

3.2. Maintenance

3.2.1. About service mode operation

Refrigerant recovery operation/vacuuming operation is possible by applying setting [2-21]. Refer to the Installer and User reference guide for details how to set mode 2.

When vacuuming/recovery mode is used, check very carefully what should be vacuumed/recovered before starting. See installation manual of the indoor unit for more information about vacuuming and recovery.

3.2.1.1 To use vacuum mode

1. When the unit is at standstill, set the unit in [2-21]=1.

Result: When confirmed, the indoor and outdoor unit expansion valves will fully open. At that moment the 7-segment display indication= $t \overline{0} 1$ and the user interface of all indoor units indicate TEST (test operation) and (external control)  and the operation will be prohibited.

2. Evacuate the system with a vacuum pump.
3. Press BS3 to stop vacuuming mode.

3.2.1.2 To recover refrigerant

This should be done by a refrigerant reclaimer. Follow the same procedure as for vacuuming method.

3.3. Maintenance after a long stop period

E.g., at the beginning of the season.

- Check and remove everything that might be blocking inlet and outlet vents of indoor units and outdoor units.
- Clean air filters and casings of indoor units. Contact your installer or maintenance person to clean air filters and casings of the indoor unit. Maintenance tips and procedures for cleaning are provided in the installation/operation manuals of dedicated indoor units. Make sure to install cleaned air filters back in the same position.

- Turn on the power at least 6 hours before operating the unit in order to ensure smoother operation. As soon as the power is turned on, the user interface display appears.

3.4. Maintenance before a long stop period

E.g., at the end of the season.

- Let the indoor units run in fan only operation for about half a day in order to dry the interior of the units. Refer to "16.2.2 About cooling, heating, fan only, and automatic operation" in the Installer and user reference guide for details on fan only operation.
- Turn off the power. The user interface display disappears.
- Clean air filters and casings of indoor units. Contact your installer or maintenance person to clean air filters and casings of the indoor unit. Maintenance tips and procedures for cleaning are provided in the installation/operation manuals of dedicated indoor units. Make sure to install cleaned air filters back in the same position.

3.5. After sales service and warranty

- If repairs to the air conditioner are necessary within the warranty period, contact your dealer.

3.5.1. Recommended maintenance and inspection

Since dust collects when using the unit for several years, performance of the unit will deteriorate to some extent. As taking

apart and cleaning interiors of units requires technical expertise and in order to ensure the best possible maintenance of your units, we recommend to enter into a maintenance and inspection contract on top of normal maintenance activities. Our network of dealers has access to a permanent stock of essential components in order to keep your air conditioner in operation as long as possible. Contact your dealer for more information.

When asking your dealer for an intervention, always state:

- The complete model name of the air conditioner.
- The manufacturing number (stated on the nameplate of the unit).
- The installation date.
- The symptoms or malfunction, and details of the defect.

3.5.2. Recommended maintenance and inspection cycles

Be aware that the mentioned maintenance and replacement cycles do not relate to the warranty period of the components.

Component	Inspection cycle	Maintenance cycle (replacements and/or repairs)
Electric motor	1 year	20,000 hours
PCB		25,000 hours
Heat exchanger		5 years
Sensor (thermistor, etc.)		5 years
User interface and switches		25,000 hours
Drain pan		8 years
Expansion valve		20,000 hours
Solenoid valve		20,000 hours

The table assumes the following conditions of use:

- Normal use without frequent starting and stopping of the unit. Depending on the model, we recommend not starting and stopping the machine more than 6 times/hour.
- Operation of the unit is assumed to be 10 hours/day and 2,500 hours/year.



NOTE

- The table indicates main components. Refer to your maintenance and inspection contract for more details.
- The table indicates recommended intervals of maintenance cycles. However, in order to keep the unit operational as long as possible, maintenance work may be required sooner. Recommended intervals can be used for appropriate maintenance design in terms of budgeting maintenance and inspection fees. Depending on the content of the maintenance and inspection contract, inspection and maintenance cycles may in reality be shorter than listed.

3.5.3. Shortened maintenance and replacement cycles

Shortening of "maintenance cycle" and "replacement cycle" needs to be considered in following situations:

The unit is used in locations where:

- Heat and humidity fluctuate out of the ordinary.
- Power fluctuation is high (voltage, frequency, wave distortion, etc.) (the unit cannot be used if power fluctuation is outside the allowable range).
- Bumps and vibrations are frequent.
- Dust, salt, harmful gas or oil mist such as sulphurous acid and hydrogen sulfide may be present in the air.
- The machine is started and stopped frequently or operation time is long (sites with 24 hour air-conditioning).

Recommended replacement cycle of wear parts

Component	Inspection cycle	Maintenance cycle (replacements and/or repairs)
Air filter	1 year	5 years
High efficiency filter		1 year
Fuse		10 year
Crankcase heater		8 years
Pressure containing parts		In case of corrosion, contact your dealer

**NOTE**

- The table indicates main components. Refer to your maintenance and inspection contract for more details.
- The table indicates recommended intervals of maintenance cycles. However, in order to keep the unit operational as long as possible, maintenance work may be required sooner. Recommended intervals can be used for appropriate maintenance design in terms of budgeting maintenance and inspection fees. Contact your dealer for details.

**NOTE**

Damage due to taking apart or cleaning interiors of units by anyone other than our authorised dealers may not be included in the warranty.

4. FXSQ20~125P7VEB VRV system air conditioners (as reference)



CAUTION

- Only a qualified service person is allowed to perform maintenance.
- Before obtaining access to terminal devices, all power supply circuits must be interrupted.
- Do not use water or air warmer than 50°C for cleaning air filters and outside panels.
- When cleaning the heat exchanger, be sure to remove the switchbox, fan motor, auxiliary electric heater and drain pump. Water or detergent may deteriorate the insulation of electronic components and result in burn-out of these components.
- If the main power supply is turned off during operation, operation will restart automatically after the power turns back on again.

4.1. How to clean the air filter

Clean the air filter when the display shows  (TIME TO CLEAN AIR FILTER).

Increase the frequency of cleaning if the unit is installed in a room where the air is extremely contaminated.

If the dirt becomes impossible to clean, change the air filter. (Air filter for exchange is optional.)

1. Open the suction grille. (Only for bottom suction.) Slide both knobs simultaneously as shown and then pull them downward.

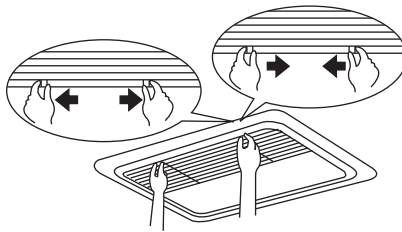

2. If chains are present, unhook the chains.

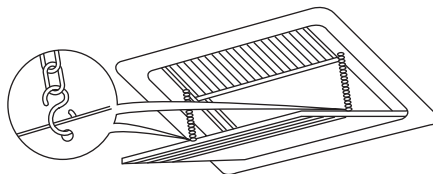

3. Remove the air filters.
Remove the air filters by pulling their cloth upward (rear suction) or backward (bottom suction).

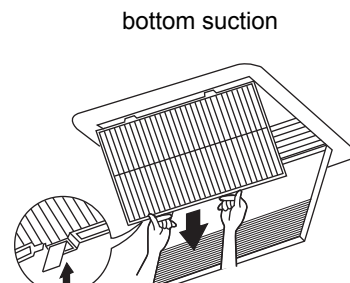
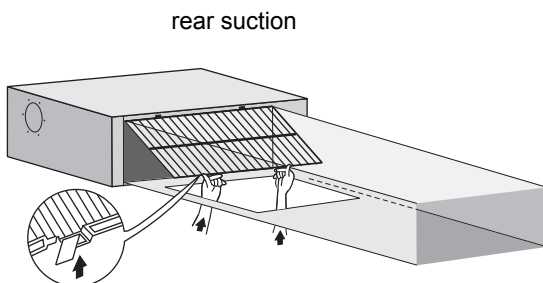

4. Clean the air filter.
Use vacuum cleaner (A) or wash the air filter with water (B).
When the air filter is very dirty, use soft brush and neutral detergent.
Remove water and dry in the shade.

(A) Using a vacuum cleaner

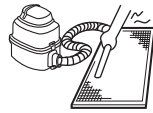

(B) Washing water



5. Fix the air filter.
Align the two hanger brackets and push the two clips in their place (pull the cloth if necessary).
Confirm that four hangers are fixed

rear suction

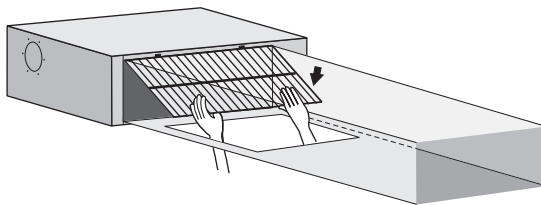

bottom suction

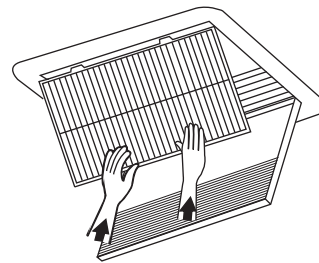

6. Shut the air inlet grille. (Only for bottom suction.) Refer to step 1.
7. After turning on the power, press FILTER SIGN RESET button.
The "TIME TO CLEAN AIR FILTER" display is turned off.

4.2. How to clean air outlet and outside panels

1. Clean with soft cloth.
2. When it is difficult to remove stains, use water of neutral detergent.
3. Clean the air inlet grille when it is shut.



NOTE

Do not use gasoline, benzene, thinner, polishing powder, liquid insecticide. It may cause discolouring or warping.
Do not let the indoor unit get wet. It may cause an electric shock or a fire.

4.3. Start up after a long stop

1. Confirm the following:
 - Check that the air inlet and outlet are not blocked. Remove any obstacle.
 - Check if the earth is connected.
2. Clean the air filter and outside panels.
 - After cleaning the air filter, make sure to attach it.
3. Turn on the main power supply switch.
 - The control panel display lights when the power is turned on.
 - To protect the unit, turn on the main power switch at least 6 hours before operation.

4.4. What to do when stopping the system for a long period

1. Turn on FAN OPERATION for half a day and dry the unit.
 - Refer to the operation manual of the outdoor unit.
2. Cut off the power supply.
 - When the main power switch is turned on, some wattage is being consumed even if the system is not operating.
 - The remote controller display is turned off when the main power switch is turned off.

Part 5. Appendix

1. Field settings

1.1 Field settings outdoor unit

Nr	Description setting	Setting contents								Default
		0	1	2	3	4	5	6	7	
0	Cooling and heating selection	Individual	Main cool / heat	Sub cool / heat						0
1	Cooling and heating simultaneously address	0~31								0
2	Low noise and demand address	0~31								0
3	Commissioning setting 2	OFF	1: ON							0
4	Leak detection operation after heating setting	OFF	1: ON							0
5	Indoor forced fan operation indoor (cross wiring check)	OFF	1: ON							0
6	Indoor forced thermostat operation (operation mode controller)	OFF	1: ON							0
7	Defrost sequential addresses	0~15								0
8	Te set cooling mode	Auto	3°C	6°C	7°C	8°C	9°C	10°C	11°C	0
9	Tc setting heating & heat recovery	Auto	41°C	42°C	43°C	44°C	46°C	47°C	48°C	0
10	Defrost switch setting	Short	Medium	Long						1
12	Low noise / demand set by DTA104	OFF	ON							0
13	Airnet address	0~63								0
14	Added automatic refrigerant filling INPUT	0~21								0
15	E3 alarm mask setting high pressure wait	OFF	ON							1
16	Hot water heater with / without setting	OFF	ON							0
18	High static pressure setting	OFF	ON							0
19	Drain pan heater setting	No output	Enekatto behaviour	Drain pan heater behaviour (a long time setting OFF)	Drain pan heater operations (long setting 1 ON)	Drain pan heater operations (long setting 2 ON)				0
20	Additional refrigerant charging operation setting	OFF	ON							0
21	Refrigerant recovery mode setting	OFF	ON							0

		Setting contents										
Nr	Description setting	0	1	2	3	4	5	6	7	8	9	Default
22	Nighttime low noise setting	OFF	Level 1	Level 2	Level 3							0
25	Low noise setting (level) input DTA104		Level 2	Level 2	Level 3							2
26	LNO auto start time		20:00	22:00	0:00							3
27	LNO auto end time		6:00	7:00	8:00							0
28	Power transistor check	OFF	ON									0
29	Ability priority setting	OFF	ON									0
30	Demand 1 setting upper limit		0.60	0.65	0.70	0.75	0.80	0.85	0.90	0.95		3
31	Demand 2 setting upper limit		0.30	0.40	0.50							2
32	Always demand setting	OFF	level 1 (2-29)	level 2 (2-30)								0
34	Indoor air volume lower limit setting	Cool / heat / C+H	Heat / C+H	Disabled								0
35	40 - 90 m (outdoor below indoor)	max. 90 m	max. 40 m									1
38	Emergency main unit	Normal	INV1 disabled	INV2 disabled	Full module							0
39	Emergency sub 1 unit	Normal	INV1 disabled	INV2 disabled	Full module							0
40	Emergency sub 2 unit	Normal	INV1 disabled	INV2 disabled	Full module							0
45	Technical cooling	Disabled	Enabled									0
47	Te set except cooling mode	Auto	3°C	6°C	7°C	8°C	9°C	10°C	11°C			0
48	Snow sensor	OFF	ON									0
49	50 - 90 m (outdoor above indoor)	max. 50 m	max. 90 m									0
50	Alternating defrost during the indoor unit setting	Indoor heating	Defrost priority									0
51	Outdoor set main - sub 1 - sub 2	Automatic	Main	Sub 1	Sub 2							0
54	BS evaporating pressure adjustment level setting	3~9°C	0~6°C	1~7°C	2~8°C	4~10°C	5~11°C	6~12°C	7~13°C	8~14°C	9~15°C	0

		Setting contents							
Nr	Description setting	0	1	2	3	4	5	6	Default
63	Cooling indoor unit lower opening change	200 pls	160 pls	140 pls	120 pls				1
66	Heating indoor unit lower opening change	200 pls	160 pls	140 pls	120 pls				0
70	Capacity less heating	OFF	Operation off	Thermostat - OFF	Operation off + thermostat - OFF				0
71	Pressure equalization time BS unit mode change over	5 minutes	3 minutes	7 minutes	4 minutes				0
81	Cooling comfort setting	ECO	MILD	Quick	Powerful				1
82	Heating comfort setting	ECO	MILD	Quick	Powerful				1
84	Heating start indoor EV instruction setting	500 pls	400 pls	600 pls	300 pls				1
85	Timer - refrigerant leak detection operation settings (day)	365	180	90	60	30	7	61	0
86	Timer - refrigerant leak detection operation performed setting	OFF	Single	Permanent					0
88	Leakage data acquisition settings for automatic filling not been implemented at the time	OFF	ON						0
90	Soft multi tenant	Disabled	Enabled						0
93	Oil return, BS bypass def during	Enabled	Disabled						0
95	EVH bypass setting heat recovery cooling BS	No bypass	Bypass						1

1.2. Field settings as per type indoor unit

Field set	Code																		
Indoor	BRC...	FXKQ-M	FXFQ-P	FXCQ-A	FXSQ-P	FXDQ-M	FXUQ-A	FXFQ-A	FXMQ-P	FXHQ-A	FXDQ-A	FXZQ-A	FXAQ-P	FXLQ	FXNQ	VKM	Biddle	EKEQM	
20	0	01	01	01	01	02	01	01	01	01	01	01	01	01	01	01	01	01	01
	1	na	01	01	na	na	01	01	na	01	04	01	01	na	na	03	01	01	
	2	02	02	02	02	02	02	02	02	02	01	02	03	02	03	na	03	02	
	3	03	02	01	02	02	01	01	01	01	01	01	01	01	01	02	02	02	01
	4	spare																	
	5	na	02	01	02	01	01	01	01	02	01	01	01	02	02	02	na	01	02
	6	na	02	01	02	01	01	01	01	02	01	01	01	02	02	02	na	01	01
	7	na	na	01	na	na	01	01	na	na	01	01	na	na	na	na	na	na	na
	8	na	02	01	na	na	01	01	na	02	01	02	na	na	na	na	na	na	01
	9	spare																	
		FXKQ-M	FXFQ-P	FXCQ-A	FXSQ-P	FXDQ-M	FXUQ-A	FXFQ-A	FXMQ-P	FXHQ-A	FXDQ-A	FXZQ-A	FXAQ-P	FXLQ	FXNQ	VKM	Biddle	EKEQM	
21	0	spare																	
	1	spare																	
	2	spare																	
	3	na	01	01	na	na	01	01	na	01	01	01	na	na	na	na	na	na	na
	4	spare																	
	5	spare																	
	6	na	na	03	na	na	03	04	na	na	04	03	na	na	na	na	na	na	na
	7	na	na	na	02	na	na	na	na	01	na	na	na	na	na	na	na	na	na
	8	na	na	03	na	na	03	01	na	na	01	03	na	na	na	na	na	na	na
	9	na	na	03	na	na	03	03	na	na	03	03	na	na	na	na	na	na	na
		FXKQ-M	FXFQ-P	FXCQ-A	FXSQ-P	FXDQ-M	FXUQ-A	FXFQ-A	FXMQ-P	FXHQ-A	FXDQ-A	FXZQ-A	FXAQ-P	FXLQ	FXNQ	VKM	Biddle	EKEQM	
22	0	02	01	01	01	02	01	01	01	01	01	01	01	01	01	01	01	01	
	1	02	01	01	01	01	01	01	02	01	01	01	01	04	01	01	02	04	
	2	02	02	01	02	01	01	02	02	01	02	01	02	02	02	01	01	02	
	3	01	01	03	01	01	01	01	02	01	01	01	01	01	01	02	na	01	01
	4	01	03	01	02	03	03	03	03	01	01	01	01	01	01	03	01	01	03
	5	02	02	02	02	02	02	02	02	02	02	02	02	02	02	02	02	02	02
	6	na	02	02	01	02	02	02	02	02	02	02	02	na	02	na	na	02	02
	7	na	01	01	01	01	01	01	01	01	01	01	01	na	01	na	na	01	01
	8	na	01	01	01	01	01	01	01	01	01	01	01	na	01	na	na	01	01
	9	01	01	01	01	01	01	01	01	01	01	01	01	01	01	01	01	01	01
		FXKQ-M	FXFQ-P	FXCQ-A	FXSQ-P	FXDQ-M	FXUQ-A	FXFQ-A	FXMQ-P	FXHQ-A	FXDQ-A	FXZQ-A	FXAQ-P	FXLQ	FXNQ	VKM	Biddle	EKEQM	
23	0	na	01	01	01	na	01	01	01	01	01	01	01	na	na	na	na	na	
	1	na	01	na	na	na	01	01	na	na	na	01	01	na	na	na	na	na	
	2	na	na	01	na	na	03	01	na	na	na	01	na	na	na	na	na	na	
	3	01	na	na	na	na	na	na	na	na	na	01	01	na	na	na	na	na	
	4	02	01	01	na	na	03	03	na	03	02	01	02	na	na	na	na	na	
	5	na	01	01	01	na	01	01	01	01	01	01	01	01	na	na	na	na	na
	6	na	na	na	15	na	na	na	na	02	na	na	na	na	na	na	na	na	na
	7	na	01	01	na	na	01	01	na	01	01	01	01	01	na	na	na	na	na
	8	na	na	na	na	na	na	na	na	na	na	na	na	na	na	na	01	02	01
	9	na	01	01	01	09	01	01	01	01	01	01	01	na	01	na	na	01	01

		FXKQ-M	FXFQ-P	FXCQ-A	FXSQ-P	FXDQ-M	FXUQ-A	FXFQ-A	FXMQ-P	FXHQ-A	FXDQ-A	FXZQ-A	FXAQ-P	FXLQ	FXNQ	VKM	Biddle	EKEQM
24	0	spare																
	1	na	01	01	01	na	01	01	02	01	01	01	na	na	na	13	na	na
	2	na	01	na	na	na	na	02	na	02	na	na	na	na	na	na	na	na
	3	na	01	na	na	na	na	01	na	01	na	na	na	na	na	01	na	na
	4	na	01	na	na	na	na	01	na	01	na	na	na	na	na	09	na	na
	5	na	01	na	na	na	na	01	na	01	na	na	na	na	na	na	na	na
	6	na	na	na	na	na	na	na	na	na	na	na	na	na	na	05	na	na
	7	01	01	01	01	01	01	01	01	01	01	01	01	01	02	01	01	01
	8	na	02	na	na	na	na	na	02	na	02	na	na	na	na	na	na	na
9	na	01	na	na	na	na	na	01	na	01	na	na	na	na	na	na	04	04
		FXKQ-M	FXFQ-P	FXCQ-A	FXSQ-P	FXDQ-M	FXUQ-A	FXFQ-A	FXMQ-P	FXHQ-A	FXDQ-A	FXZQ-A	FXAQ-P	FXLQ	FXNQ	VKM	Biddle	EKEQM
25	0	na	02	02	02	na	02	02	01	02	02	02	na	na	na	na	na	na
	1	01	01	01	01	01	01	01	02	01	01	01	01	01	02	01	01	02
	2	na	01	01	na	na	01	01	na	01	01	01	01	na	na	na	na	na
	3	01	01	01	01	01	01	01	01	01	01	01	01	01	01	02	01	02
	4	na	01	01	01	na	01	01	01	01	01	01	01	na	na	na	na	na
	5	01	01	01	01	01	01	01	01	01	01	01	01	01	01	01	01	01
	6	01	01	01	01	01	01	01	01	01	01	01	01	01	01	01	01	01
	7	spare																
	8	spare																
9	01	01	01	na	01	na	01	01	01	01	01	01	01	01	01	01	01	02

1.3. Field settings full overview



INFORMATION

The full overview lists all possible settings for the indoor unit (not all combinations are possible for all types, see "Field settings as per type indoor unit" on page 209).

Mode	1st code	Description function	2nd code	Description selection
10(20)	0	Filter contamination heavy / light	01	Filter contamination: light LL 2500 hr / flat 200 hr
			02	Filter contamination: heavy LL 1250 hr / flat 100 hr
	1	Long life filter type	01	Long life filter
			02	Super long life filter
			04	Oil guard filter
	2	Air thermistor selection	01	Combined control
			02	Only the return air thermistor
			03	Only the remote controller thermistor
	3	Display filter sign	01	Display
			02	No display
	4	Spare	--	--
	5	Air thermistor selection in group wiring P1P2	01	Return air thermistor (individual units)
			02	Thermistor designated by field set 20-2 (see above)
6	Remote controller thermistor visible by central control device in group wiring P1P2	01	No	
		02	Yes	
7	Absence delay detecting time (presence sensor)	01	30 minutes	
		02	60 minutes	
8	Compensation air sensor heating	01	Add 2.0°C to measurement air sensor	
		02	Measurement air sensor	
9	Spare	--	--	
11(21)	3	Fan setting of heating	01	Standard
			02	Slight increase
			03	Increase
	6	Sensitivity presence sensor	01	High sensitive
			02	Low sensitive
			03	Standard
			04	Disable presence sensor
	7	Airflow adjustment	01	Manual setting (see mode 23-6 below)
			02	ESP auto judgment completed
			03	Start ESP auto judgment (if control set to fan only + ON)
	8	Compensation by floor sensor	01	Floor sensor disabled
			02	Air suction temperature priority
			03	Standard
			04	Floor temperature priority
	9	Compensation of floor temperature	01	-4°C
			02	-2°C
03			No correction	
04			+2°C	

Mode	1st code	Description function	2nd code	Description selection
12(22)	0	Optional board KRP1A... output X1X2	01	Indoor unit turned ON by thermostat
			02	--
			03	Operation output
			04	Malfunction output
			05	--
	1	T1T2 input signal	01	Forced OFF
			02	ON/OFF control
			03	External protection device input
			04	Forced OFF - multi tenant
	2	Thermostat differential to set point	01	1.0°C (FXFQ, FXZQ, FXCQ, FXKQ, FXUQ, FXHQ, VKM, "Biddle")
			02	0.5°C (FXSQ, FXMQ, FXAQ, FXLQ, FXNQ, FXDQ, EKEQM)
	3	OFF by thermostat fan speed	01	LL
			02	Set fan speed
			03	OFF
	4	Automatic mode differential	01	0°C
			02	1°C
			03	2°C
			04	3°C
			05	4°C
			06	5°C
			07	6°C
			08	7°C
	5	Auto restart after power failure	01	Disabled
			02	Enabled
	6	Fan speed in cooling thermo off	01	LL
			02	Set speed
			03	OFF
	9	Forced C/H master	01	Disabled (select by cool / heat selection button controller)
			02	ON (not possible by cool / heat selection button controller)

Mode	1st code	Description function	2nd code	Description selection
13(23)	0	Air flow amount setting (ceiling height)	01	Standard
			02	High
			03	Extra high
	1	Number of air outlet 4-blow panel	01	4-blow directions
			02	3-blow directions
			03	2-blow directions
	2	Swing pattern setting if 4 swing motors	01	All direction simultaneously swing
			02	--
			03	Opposite sides synchronization swing
	3	Output to flap motor	01	Enabled
			02	Disabled
			03	--
	4	Air flow position setting	01	Draft prevention
			02	Standard
			03	Ceiling soiling prevention
	5	ESP setting phase control motor	01	Standard
			02	Increase step 1
			03	Increase step 2
			04	--
	6	External static pressure manual set	01	--
			02	50 Pa
			03	60 Pa
			04	70 Pa
			05	80 Pa
			06	90 Pa
			07	100 Pa
			08	110 Pa
			09	120 Pa
			10	130 Pa
			11	140 Pa
			12	150 Pa
			13	160 Pa
			14	180 Pa
15			200 Pa	
7	Thermostat swing	01	Equipped	
		02	Not equipped	
8	Auto cleaning program	01	Choice between auto and schedule	
		02	Only schedule (auto not in menu)	
9	Dust amount setting	01	Standard	
		02	Dust amount big	

Mode	1st code	Description function	2nd code	Description selection
15(25)	0	Air cleaner	01	Not equipped
			02	Equipped
	1	Thermostat OFF excess humidity	01	Not equipped
			02	Equipped
	2	Direct duct connection	01	Not equipped
			02	Equipped
	3	Drain pump operation heating operation (if humidifier is used)	01	Not equipped
			02	Equipped
	4	Filter sign	01	By timer
			02	By external input
	5	Independent ventilation	01	Not equipped
			02	Equipped
	6	Independent unit	01	No
			02	Yes
	9	Demand control	01	Not equipped
			02	Equipped

2. Wiring diagrams

2.1 Wiring diagram REMQ5T7Y1B-REYQ8T7Y1B

Figure 93 - Wiring diagram REMQ5T7Y1B-REYQ8T7Y1B

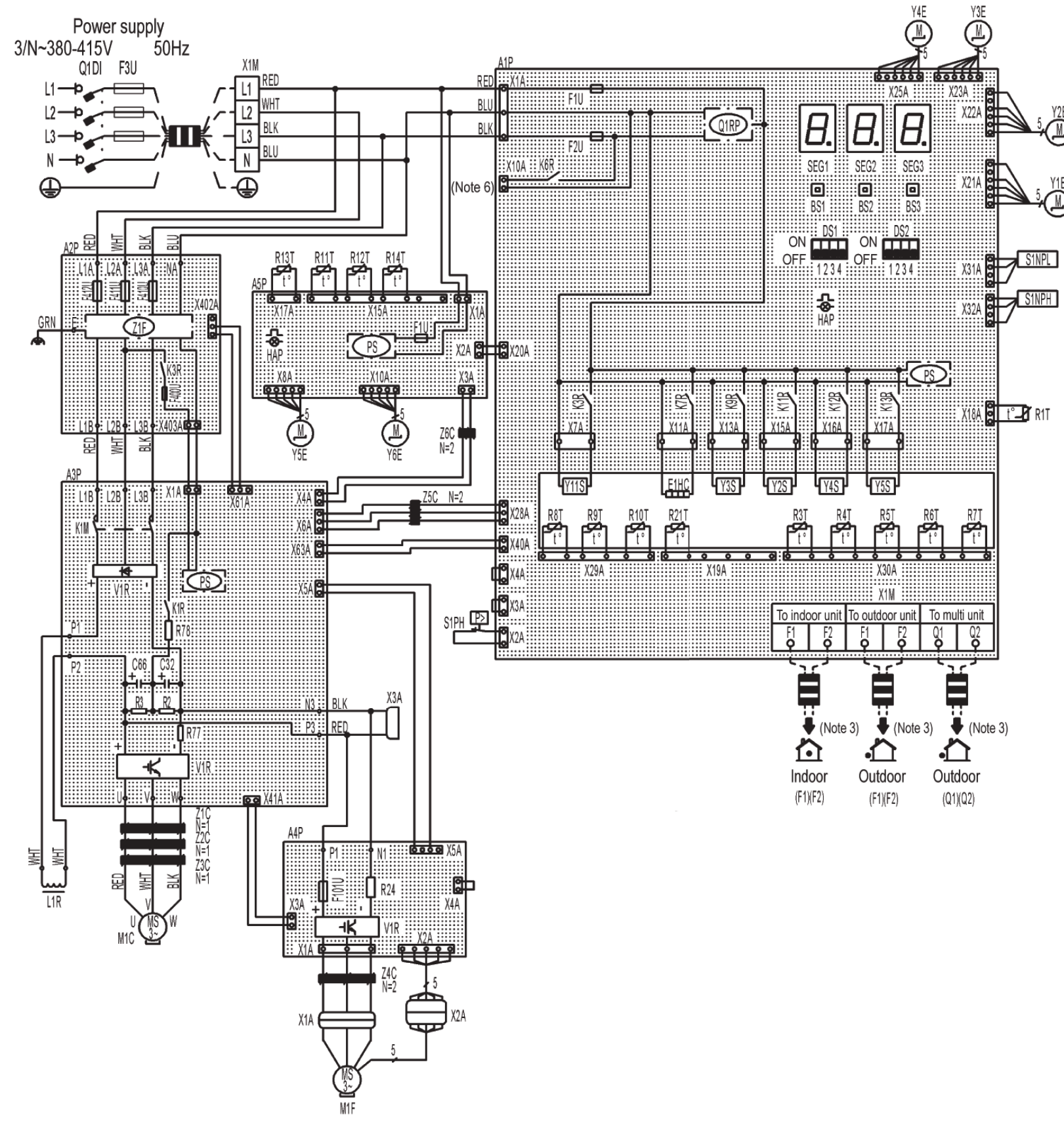

2.2 Wiring diagram REMQ5T7Y1B-REYQ8T7Y1B (switchbox layout)

Figure 94 - Wiring diagram REMQ5T7Y1B-REYQ8T7Y1B (switchbox layout)

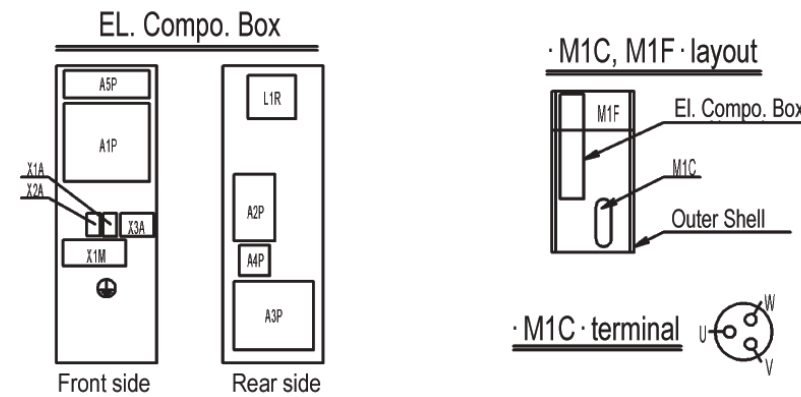

A1P	Printed Circuit Board (main)	K13R	Magnetic Relay (Y5S) (A1P)	SEG1~SEG3	7-Segment Display (A1P)
A2P	Printed Circuit Board (noise filter)	L1R	Reactor	V1R	Power Module (A3P) (A4P)
A3P	Printed Circuit Board (inv)	M1C	Motor (Compressor)	X1A, X2A	Connector (M1F)
A4P	Printed Circuit Board (fan)	M1F	Motor (Fan)	X3A	Connector (check the residual charge)
A5P	Printed Circuit Board (sub)	PS	Switching Power Supply (A1P) (A3P) (A5P)	X1M	Terminal Block (Power Supply)
BS1~3	Push Button Switch (A1P) (Mode, Set, Return)	Q1DI	Field Earth Leakage Breaker	X1M	Terminal Block (Control) (A1P)
		Q1RP	Phase Reversal Detect Circuit (A1P)	Y1E	Electronic Expansion Valve (Heat Exc. Upper)
C66, C32	Capacitor (A3P)	R1T	Thermistor (Air) (A1P)	Y2E	Electronic Expansion Valve (Subcool Heat Exc.)
DS1, DS2	DIP Switch (A1P)	R21T	Thermistor (M1C Discharge) (A1P)	Y3E	Electronic Expansion Valve (Heat Exc. Lower)
E1HC	Crankcase Heater	R3T	Thermistor (Liq. Main) (A1P)	Y4E	Electronic Expansion Valve (Receiver Gas)
F1U, F2U	Fuse (T, 3,15A, 250V) (A1P)	R4T	Thermistor (Heat Exc. Liq. Upper) (A1P)	Y5E	Electronic Expansion Valve (Inverter Cooling)
F1U	Fuse (T, 3,15A, 250V) (A5P)	R5T	Thermistor (Heat Exc. Liq. Lower) (A1P)	Y6E	Electronic Expansion Valve (Auto Charge)
F101U	Fuse (A4P)	R6T	Thermistor (Subcool Heat Exc. Gas) (A1P)	Y11S	Solenoid Valve (M1C Oil Return)
F3U	Field Fuse	R7T	Thermistor (Subcool Heat Exc. Liq) (A1P)	Y2S	Solenoid Valve (Liq. Pipe)
F410U~F412U	Fuse (A2P)	R8T	Thermistor (Heat Exc. Gas Upper) (A1P)	Y3S	Solenoid Valve (HP/LP Gas Pipe)
F400U	Fuse (A2P)	R9T	Thermistor (Heat Exc. Gas Lower) (A1P)	Y4S	Solenoid Valve (Heat Exc. Lower)
HAP	Pilotlamp (A1P) (A5P) (Service monitor-green)	R10T	Thermistor (Suction) (A1P)	Y5S	Solenoid Valve (Heat Exc. Upper)
		R11T	Thermistor (Heat Exc. Deicer) (A5P)	Z1C~Z6C	Noise Filter (Ferrite Core)
K1M	Magnetic Contactor (A3P)	R12T	Thermistor (Suction Compressor) (A5P)	Z1F	Noise Filter (A2P) (With Surge Absorber)
K1R	Magnetic Relay (A3P)	R13T	Thermistor (Receiver Gas) (A5P)		
K3R	Magnetic Relay (A2P)	R14T	Thermistor (Auto Charge) (A5P)		
K3R	Magnetic Relay (Y11S) (A1P)	R78	Resistor (Current Limiting) (A3P)		Connector for Optional Accessories
K6R	Magnetic Relay (Optional Bottomplate Heater) (A1P)	R24	Resistor (Current Sensor) (A4P)	X10A	Connector (Bottom plate Heater)
		R77	Resistor (Current Sensor) (A3P)		
K7R	Magnetic Relay (E1HC) (A1P)	R3, R2	Resistor (A3P)		
K9R	Magnetic Relay (Y3S) (A1P)	S1NPH	Pressure Sensor (High)		
K11R	Magnetic Relay (Y2S) (A1P)	S1NPL	Pressure Sensor (Low)		
K12R	Magnetic Relay (Y4S) (A1P)	S1PH	Pressure Switch (High)		

NOTES

1. This wiring diagram applies only to the outdoor unit.
2. : field wiring, : terminal block, : connector, : terminal, : Protective Earth (Screw).
3. For connection wiring to indoor-outdoor transmission F1-F2, outdoor-outdoor transmission F1-F2, outdoor-multi transmission Q1-Q2, refer to the installation manual.
4. When operating, don't shortcircuit the protection device (S1PH)
5. Colors BLK:BLACK; RED: RED; BLU; BLUE; WHT: WHITE; GRN: GREEN.
6. When using the optional accessory, refer to the installation manual of the optional accessory.

2.3 Wiring diagram REYQ10~12T7Y1B

Figure 95 - Wiring diagram REYQ10~12T7Y1B

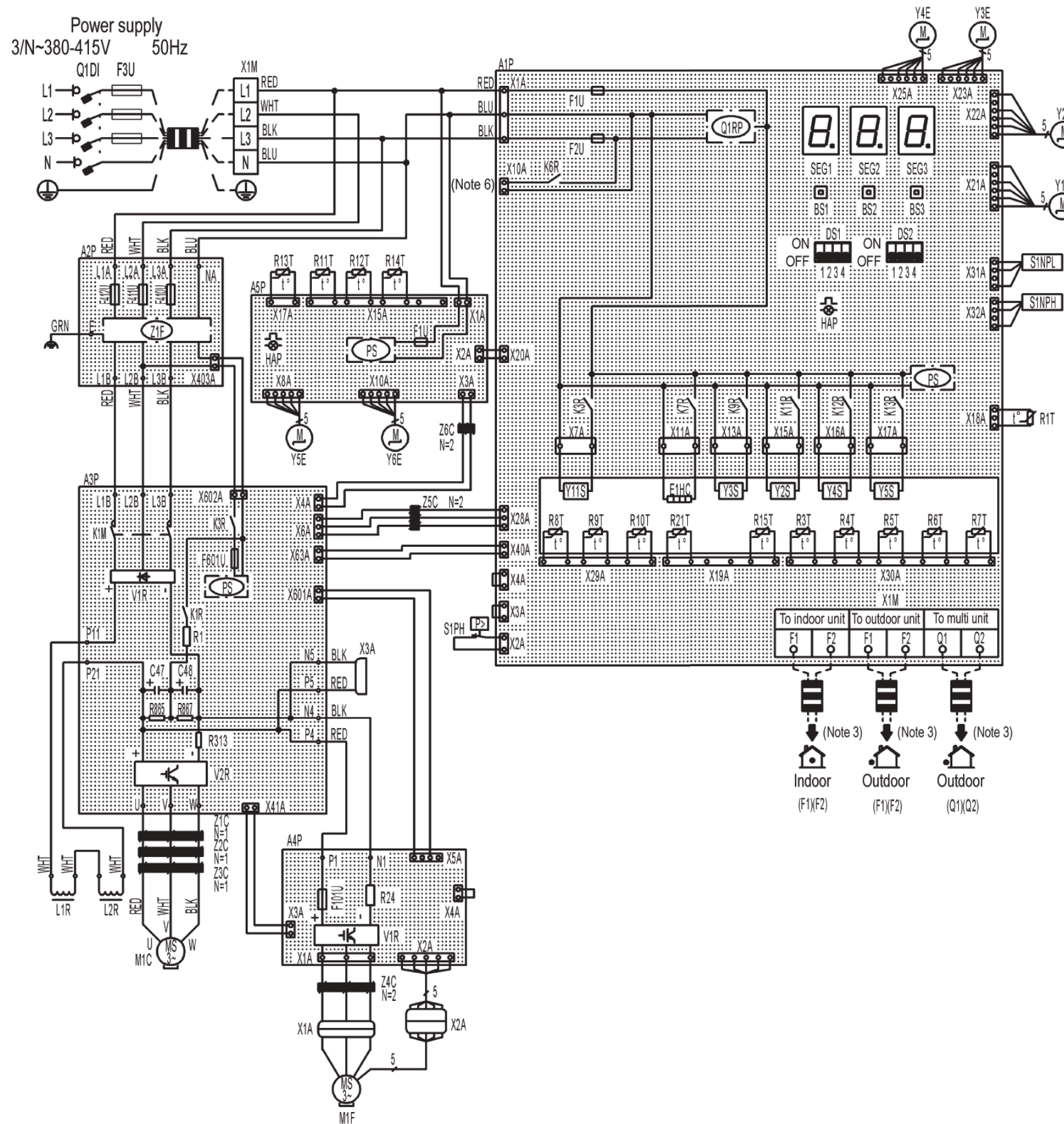

2.4 Wiring diagram REYQ10~12T7Y1B (switchbox layout)

Figure 96 - Wiring diagram REYQ10~12T7Y1B (switchbox layout)

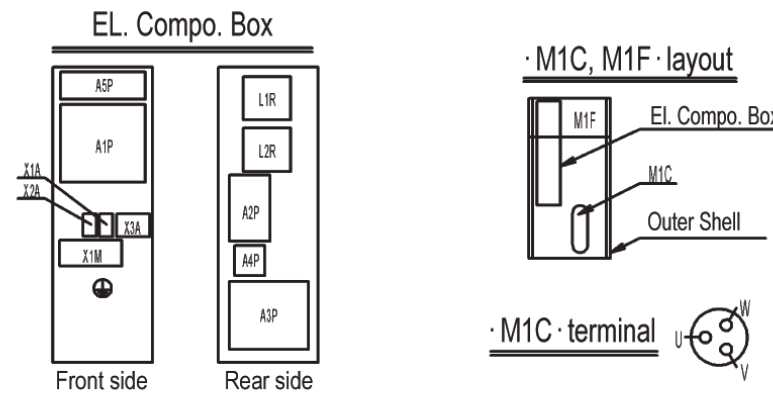

A1P	Printed Circuit Board (main)	K13R	Magnetic Relay (Y5S) (A1P)	S1PH	Pressure Switch (High)
A2P	Printed Circuit Board (noise filter)	L1R, L2R	Reactor	SEG1~SEG3	7-Segment Display (A1P)
A3P	Printed Circuit Board (inv)	M1C	Motor (Compressor)	V1R	Power Module (A3P) (A4P)
A4P	Printed Circuit Board (fan)	M1F	Motor (Fan)	V2R	Power Module (A3P)
A5P	Printed Circuit Board (sub)	PS	Switching Power Supply (A1P) (A3P) (A5P)	X1A, X2A	Connector (M1F)
BS1~3	Push Button Switch (A1P) (Mode, Set, Return)	Q1DI	Field Earth Leakage Breaker	X3A	Connector (check the residual charge)
		Q1RP	Phase Reversal Detect Circuit (A1P)	X1M	Terminal Block (Power Supply)
C47, C48	Capacitor (A3P)	R1T	Thermistor (Air) (A1P)	X1M	Terminal Block (Control) (A1P)
DS1, DS2	DIP Switch (A1P)	R21T	Thermistor (M1C Discharge) (A1P)	Y1E	Electronic Expansion Valve (Heat Exc. Upper)
E1HC	Crankcase Heater	R3T	Thermistor (Liq. Main) (A1P)	Y2E	Electronic Expansion Valve (Subcool Heat Exc.)
F1U, F2U	Fuse (T, 3,15A, 250V) (A1P)	R4T	Thermistor (Heat Exc. Liq. Upper) (A1P)	Y3E	Electronic Expansion Valve (Heat Exc. Lower)
F1U	Fuse (T, 3,15A, 250V) (A5P)	R5T	Thermistor (Heat Exc. Liq. Lower) (A1P)	Y4E	Electronic Expansion Valve (Receiver Gas)
F101U	Fuse (A4P)	R6T	Thermistor (Subcool Heat Exc. Gas) (A1P)	Y5E	Electronic Expansion Valve (Inverter Cooling)
F3U	Field Fuse	R7T	Thermistor (Subcool Heat Exc. Liq) (A1P)	Y6E	Electronic Expansion Valve (Auto Charge)
F410U~F412U	Fuse (A2P)	R8T	Thermistor (Heat Exc. Gas Upper) (A1P)	Y11S	Solenoid Valve (M1C Oil Return)
F601U	Fuse (A3P)	R9T	Thermistor (Heat Exc. Gas Lower) (A1P)	Y2S	Solenoid Valve (Liq. Pipe)
HAP	Pilotlamp (A1P) (A5P) (Service monitor-green)	R10T	Thermistor (Suction) (A1P)	Y3S	Solenoid Valve (HP/LP Gas Pipe)
		R11T	Thermistor (Heat Exc. Deicer) (A5P)	Y4S	Solenoid Valve (Heat Exc. Lower)
K1M	Magnetic Contactor (A3P)	R12T	Thermistor (Suction Compressor) (A5P)	Y5S	Solenoid Valve (Heat Exc. Upper)
K1R	Magnetic Relay (A3P)	R13T	Thermistor (Receiver Gas) (A5P)	Z1C~Z6C	Noise Filter (Ferrite Core)
K3R	Magnetic Relay (A3P)	R14T	Thermistor (Auto Charge) (A5P)	Z1F	Noise Filter (A2P) (With Surge Absorber)
K3R	Magnetic Relay (Y11S) (A1P)	R15T	Thermistor (Compressor Body) (A1P)		
K6R	Magnetic Relay (Optional Bottomplate Heater) (A1P)	R1	Resistor (Current Limiting) (A3P)		
		R24	Resistor (Current Sensor) (A4P)		
K7R	Magnetic Relay (E1HC) (A1P)	R313	Resistor (Current Sensor) (A3P)		Connector for Optional Accessories
K9R	Magnetic Relay (Y3S) (A1P)	R865, R867	Resistor (A3P)	X10A	Connector (Bottomplate Heater)
K11R	Magnetic Relay (Y2S) (A1P)	S1NPH	Pressure Sensor (High)		
K12R	Magnetic Relay (Y4S) (A1P)	S1NPL	Pressure Sensor (Low)		

NOTES

1. This wiring diagram applies only to the outdoor unit.
2. : field wiring, : terminal block, : connector, : terminal, : Protective Earth (Screw).
3. For connection wiring to indoor-outdoor transmission F1-F2, outdoor-outdoor transmission F1-F2, outdoor-multi transmission Q1-Q2, refer to the installation manual.
4. When operating, don't shortcircuit the protection device (S1PH)
5. Colors BLK:BLACK; RED: RED; BLU: BLUE; WHT: WHITE; GRN: GREEN.
6. When using the optional accessory, refer to the installation manual of the optional accessory.

2.5 Wiring diagram REYQ14~16T7Y1B

Figure 97 - Wiring diagram REYQ14~16T7Y1B

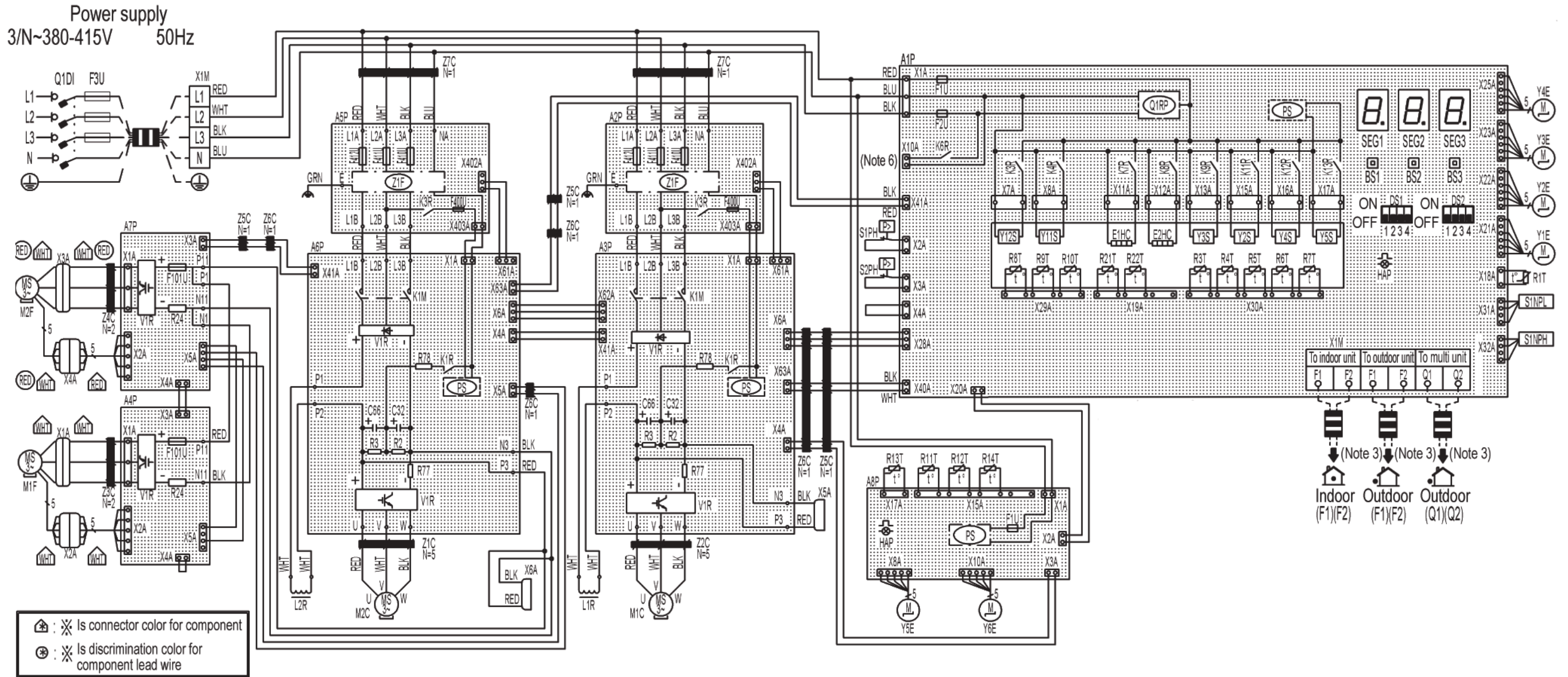

2.6 Wiring diagram REYQ14~16T7Y1B (switchbox layout)

Figure 98 - Wiring diagram REYQ14~16T7Y1B (switchbox layout)

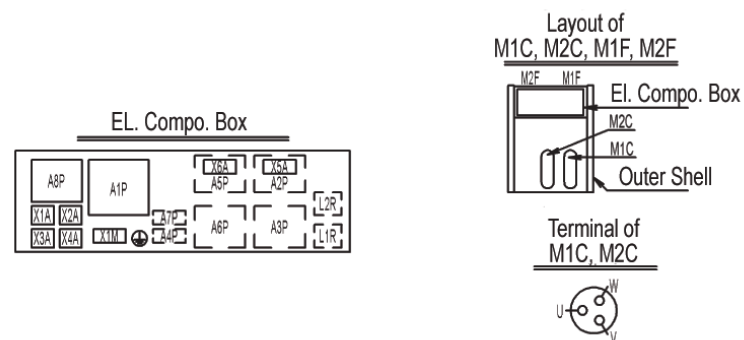

A1P	Printed Circuit Board (main)	K13R	Magnetic Relay (Y5S) (A1P)	V1R	Power Module (A3P) (A6P)
A2P, A5P	Printed Circuit Board (noise filter)	L1R~L2R	Reactor	V1R	Power Module (A4P) (A7P)
A3P, A6P	Printed Circuit Board (inv)	M1C, M2C	Motor (Compressor)	X1A~4A	Connector (M1F, M2F)
A4P, A7P	Printed Circuit Board (fan)	M1F, M2F	Motor (Fan)	X5A, X6A	Connector (Residual Charge Check)
A8P	Printed Circuit Board (sub)	PS	Switching Power Supply (A1P) (A3P) (A6P) (A8P)	X1M	Terminal Block (Power Supply)
BS1~3	Push Button Switch (A1P) (Mode, Set, Return)	Q1DI	Field Earth Leakage Breaker	X1M	Terminal Block (Control) (A1P)
C32, C66	Capacitor (A3P) (A6P)	Q1RP	Phase Reversal Detect Circuit (A1P)	Y1E	Electronic Expansion Valve (Heat Exc. Upper)
DS1, DS2	DIP Switch (A1P)	R2, R3	Resistor (A3P) (A6P)	Y2E	Electronic Expansion Valve (Subcool Heat Exc.)
E1HC, E2HC	Crankcase Heater	R24	Resistor (Current Sensor) (A4P) (A7P)	Y3E	Electronic Expansion Valve (Heat Exc. Lower)
F1U, F2U	Fuse (T, 3,15A, 250V) (A1P)	R77	Resistor (Current Sensor) (A3P) (A6P)	Y4E	Electronic Expansion Valve (Receiver Gas)
F1U	Fuse (T, 3,15A, 250V) (A8P)	R78	Resistor (Current Limiting) (A3P) (A6P)	Y5E	Electronic Expansion Valve (Inverter Cooling)
F3U	Field Fuse	R1T	Thermistor (Air) (A1P)	Y6E	Electronic Expansion Valve (Auto Charge)
F101U	Fuse (A4P) (A7P)	R21T, R22T	Thermistor (M1C, M2C Discharge) (A1P)	Y11S	Solenoid Valve (Oil Return M1C)
F400U	Fuse (A2P) (A5P)	R3T	Thermistor (Liq. Main) (A1P)	Y12S	Solenoid Valve (Oil Return M2C)
F410U~F412U	Fuse (A2P) (A5P)	R4T	Thermistor (Heat Exc. Liq. Upper) (A1P)	Y2S	Solenoid Valve (Liq. Pipe)
HAP	Pilotlamp (A1P) (A8P) (Service monitor-green)	R5T	Thermistor (Heat Exc. Liq. Lower) (A1P)	Y3S	Solenoid Valve (HP/LP Gas Pipe)
K1M	Magnetic Contactor (A3P) (A6P)	R6T	Thermistor (Subcool Heat Exc. Gas) (A1P)	Y4S	Solenoid Valve (Heat Exc. Lower)
K1R	Magnetic Relay (A3P) (A6P)	R7T	Thermistor (Subcool Heat Exc. Liq) (A1P)	Y5S	Solenoid Valve (Heat Exc. Upper)
K3R	Magnetic Relay (A2P) (A5P)	R8T	Thermistor (Heat Exc. Gas Upper) (A1P)	Z1C~Z7C	Noise Filter (Ferrite Core)
K3R	Magnetic Relay (Y11S) (A1P)	R9T	Thermistor (Heat Exc. Gas Lower) (A1P)	Z1F	Noise Filter (A2P) (A5P) (with surge absorber)
K4R	Magnetic Relay (Y12S) (A1P)	R10T	Thermistor (Suction) (A1P)		
K6R	Magnetic Relay (A1P) (Optional Bottomplate Heater)	R11T	Thermistor (Heat Exc. Deicer) (A8P)		
K7R	Magnetic Relay (E1HC) (A1P)	R12T	Thermistor (Suction compressor) (A8P)		Connector for Optional Accessories
K8R	Magnetic Relay (E2HC) (A1P)	R13T	Thermistor (Receiver Gas) (A8P)	X10A	Connector (Bottom Plate Heater)
K9R	Magnetic Relay (Y3S) (A1P)	R14T	Thermistor (Auto Charge) (A8P)		
K11R	Magnetic Relay (Y2S) (A1P)	S1NPH	Pressure Sensor (High)		
K12R	Magnetic Relay (Y4S) (A1P)	S1NPL	Pressure Sensor (Low)		
		S1PH, S2PH	Pressure Switch (High)		
		SEG1~SEG3	7-Segment Display (A1P)		

NOTES

1. This wiring diagram applies only to the outdoor unit.
2. $\text{---} \square \square \square \text{---}$:field wiring, $\square \square \square$: terminal block, $\square \square$: connector, $\text{---} \circ \text{---}$: terminal, \oplus : Protective Earth (Screw).
3. For connection wiring to indoor-outdoor transmission F1-F2, outdoor-outdoor transmission F1-F2, outdoor-multi transmission Q1-Q2, refer to the installation manual.
4. When operating, don't shortcircuit the protection devices (S1PH,S2PH)
5. Colours BLK:BLACK; RED: RED; BLU; BLUE; WHT: WHITE; GRN: GREEN.
6. When using the optional accessory, refer to the installation manual of the optional accessory.

2.7 Wiring diagram REYQ18~20T7Y1B

Figure 99 - Wiring diagram REYQ18~20T7Y1B

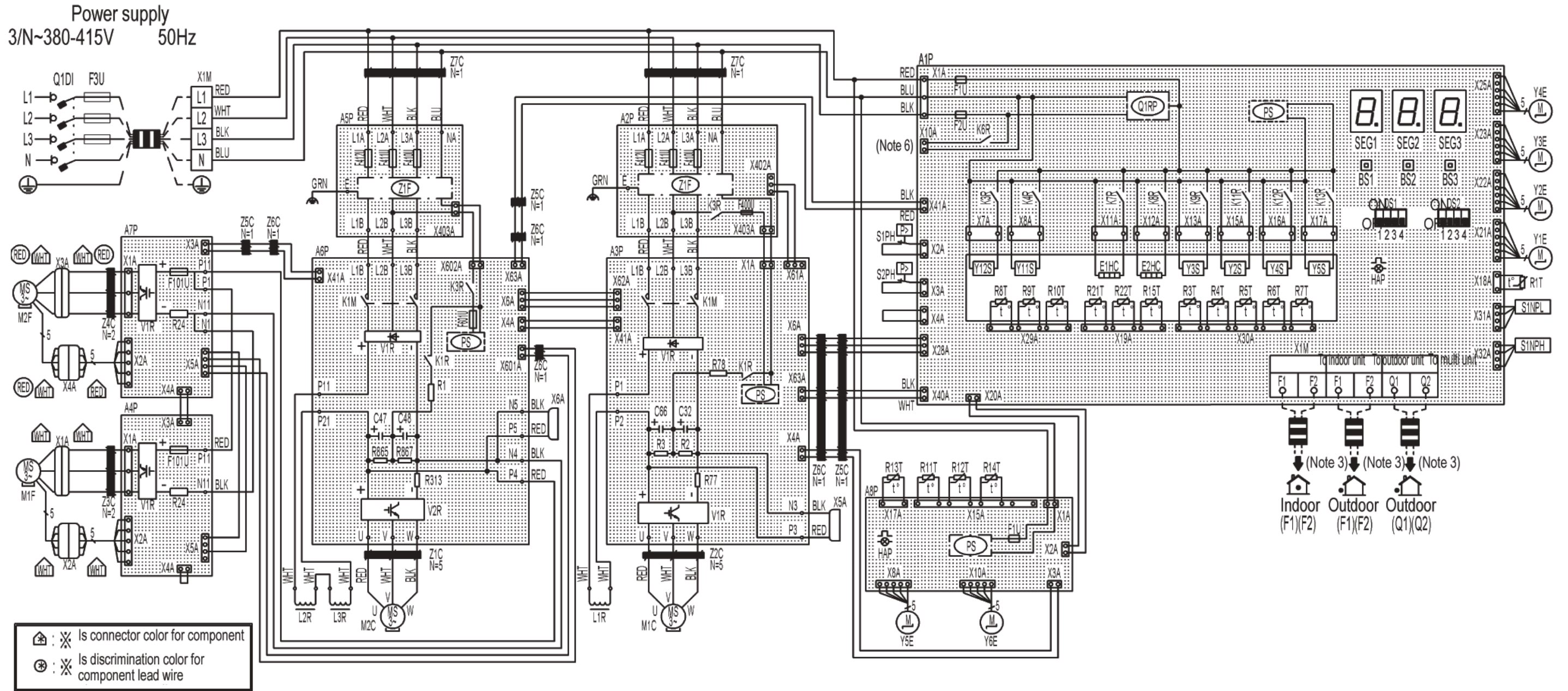

2.8 Wiring diagram REYQ18~20T7Y1B (switchbox layout)

Figure 100 - Wiring diagram REYQ18~20T7Y1B (switchbox layout)

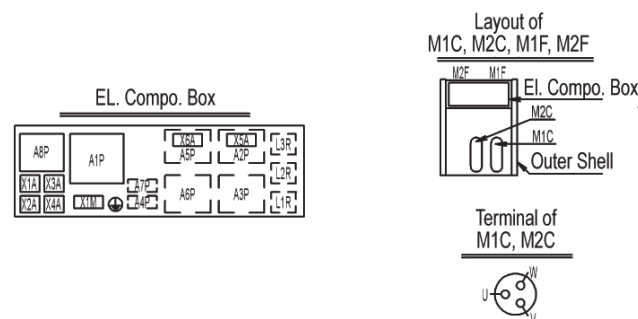

A1P	Printed Circuit Board (main)	PS	Switching Power Supply (A1P) (A3P) (A6P) (A8P)	X1M	Terminal Block (Power Supply)
A2P, A5P	Printed Circuit Board (noise filter)			X1M	Terminal Block (Control) (A1P)
A3P, A6P	Printed Circuit Board (inv)	Q1DI	Field Earth Leakage Breaker	Y1E	Electronic Expansion Valve (Heat Exc. Upper)
A4P, A7P	Printed Circuit Board (fan)	Q1RP	Phase Reversal Detect Circuit (A1P)	Y2E	Electronic Expansion Valve (Subcool Heat Exc.)
A8P	Printed Circuit Board (sub)	R1	Resistor (Current Limiting) (A6P)		
BS1~3	Push Button Switch (A1P) (Mode, Set, Return)	R2, R3	Resistor (A3P)	Y3E	Electronic Expansion Valve (Heat Exc. Lower)
		R24	Resistor (Current Sensor) (A4P) (A7P)	Y4E	Electronic Expansion Valve (Receiver Gas)
C32, C66	Capacitor (A3P)	R77	Resistor (Current Sensor) (A3P)		
C47, C48	Capacitor (A6P)	R78	Resistor (Current Limiting) (A3P)	Y5E	Electronic Expansion Valve (Inverter Cooling)
DS1, DS2	DIP Switch (A1P)	R313	Resistor (Current Sensor) (A6P)	Y6E	Electronic Expansion Valve (Auto Charge)
E1HC, E2HC	Crankcase Heater	R865, R867	Resistor (A6P)	Y11S	Solenoid Valve (Oil Return M1C)
F1U, F2U	Fuse (T, 3, 15A, 250V) (A1P) (A8P)	R1T	Thermistor (Air) (A1P)	Y12S	Solenoid Valve (Oil Return M2C)
F3U	Field Fuse	R21T, R22T	Thermistor (M1C, M2C Discharge) (A1P)	Y2S	Solenoid Valve (Liq. Pipe)
F101U	Fuse (A4P) (A7P)	R3T	Thermistor (Liq. Main) (A1P)	Y3S	Solenoid Valve (HP/LP Gas Pipe)
F400U	Fuse (A2P)	R4T	Thermistor (Heat Exc. Liq. Upper) (A1P)	Y4S	Solenoid Valve (Heat Exc. Lower)
F410U~F412U	Fuse (A2P) (A5P)	R5T	Thermistor (Heat Exc. Liq. Lower) (A1P)	Y5S	Solenoid Valve (Heat Exc. Upper)
F601U	Fuse (A6P)	R6T	Thermistor (Subcool Heat Exc. Gas) (A1P)	Z1C~Z7C	Noise Filter (Ferrite Core)
HAP	Pilotlamp (A1P) (A8P) (Service monitor-green)	R7T	Thermistor (Subcool Heat Exc. Liq) (A1P)	Z1F	Noise Filter (A2P) (A5P) (with surge absorb)
		R8T	Thermistor (Heat Exc. Gas Upper) (A1P)		
		R9T	Thermistor (Heat Exc. Gas Lower) (A1P)		
K1M	Magnetic Contactor (A3P) (A6P)	R10T	Thermistor (Suction) (A1P)		Connector for Optional Accessories
K1R	Magnetic Relay (A3P) (A6P)	R11T	Thermistor (Heat Exc. Deicer) (A8P)	X10A	Connector (Bottomplate Heater)
K3R	Magnetic Relay (A2P) (A6P)	R12T	Thermistor (Suction Compressor) (A8P)		
K4R	Magnetic Relay (Y11S) (A1P)	R13T	Thermistor (Receiver Gas) (A8P)		
K6R	Magnetic Relay (A1P) (Optional Bottomplate Heater)	R14T	Thermistor (Auto Charge) (A8P)		
		R15T	Thermistor (Compressor Body) (A1P)		
K7R	Magnetic Relay (E1HC) (A1P)	S1NPH	Pressure Sensor (High)		
K8R	Magnetic Relay (E2HC) (A1P)	S1NPL	Pressure Sensor (Low)		
K9R	Magnetic Relay (Y3S) (A1P)	S1PH, S2PH	Pressure Switch (High)		
K11R	Magnetic Relay (Y2S) (A1P)	SEG1~SEG3	7-Segment Display (A1P)		
K12R	Magnetic Relay (Y4S) (A1P)	V1R	Power Module (A3P) (A6P)		
K13R	Magnetic Relay (Y5S) (A1P)	V1R	Power Module (A4P) (A7P)		
L1R~L3R	Reactor	V2R	Power Module (A6P)		
M1C, M2C	Motor (Compressor)	X1A~4A	Connector (M1F, M2F)		
M1F, M2F	Motor (Fan)	X5A, X6A	Connector (Residual Charge Check)		

NOTES

1. This wiring diagram applies only to the outdoor unit.
2. : field wiring, : terminal block, : connector, : terminal, : Protective Earth (Screw).
3. For connection wiring to indoor-outdoor transmission F1-F2, outdoor-outdoor transmission F1-F2, outdoor-multi transmission Q1-Q2, refer to the installation manual.
4. When operating, don't shortcircuit the protection devices (S1PH, S2PH)
5. Colours BLK:BLACK; RED: RED; BLU; BLUE; WHT: WHITE; GRN: GREEN.
6. When using the optional accessory, refer to the installation manual of the optional accessory.

3. Safety device setting value

Name part	Description	Wiring symbol	REM-Q-T		REY-Q-T					
			5	8	10	12	14	16	18	20
Compressor 1	Model	M1C	JT1GCVDKYR		JT15J-VDKYR		JT1GCVDKYR			
	Overcurrent (A)			16,1	22,5		16,1			
Compressor 2	Model	M2C					JT1GCVDKYR		JT15J-VDKYR	
	Overcurrent (A)						16,1		22,5	
Fan motor 1	Overcurrent (A)	MF1	7,7							
Fan motor 2	Overcurrent (A)	MF2	7,7							
Expansion valve	Upper heat exchanger	Y1E	Fully closed 0 pulses, opening 160~3000 pulses - 4 pole, coil 150 ohm							
	Sub-cool heat exchanger	Y2E	Fully closed 0 pulses, opening 20~480 pulses, coil 46 ohm							
	Lower heat exchanger	Y3E	Fully closed 0 pulses, opening 160~3000 pulses - 4 pole, coil 150 ohm							
	Purge liquid receiver	Y4E	Fully closed 0 pulses, opening 160~3000 pulses - 4 pole, coil 150 ohm							
	Inverter cooling	Y5E	Fully closed 0 pulses, opening 20~480 pulses, coil 46 ohm							
	Auto-charge	Y6E	Fully closed 0 pulses, opening 20~480 pulses, coil 46 ohm							
High pressure switch	Compressor 1	S1PH	Off (open) 4,0 MPa, on (close) below 3,0 MPa							
	Compressor 2	S2PH	Off (open) 4,0 MPa, on (close) below 3,0 MPa							
Discharge temperature (°C)	Compressor 1	R21T	Off > 135°C 2 times in 100 minutes							
	Compressor 2	R22T	Off > 135°C 2 times in 100 minutes							
Compressor body temperature	Compressor 2	R8T	Off > 120°C 2 times in 100 minutes				Off > 120°C 2 times in 100 minutes			
Inverter fin temperature (°C)	Compressor 1		99		84		99			
	Compressor 2						99		84	
Fuse control	Control board	F1U (A)	3,15							
		F2U (A)	3,15							
Fuse noise filter compressor 1	Control circuit inverter	F400U	6,3		84		6,3			
	Main power inverter	F410~412U	40		63		40			
Fuse noise filter compressor 2	Control circuit inverter	F400U					6,3			
	Main power inverter	F410~412U					40		63	
Fuse inverter board control circuit		F601U			3,15				3,15	

4. Piping diagram

Figure 101 - Piping diagram REMQ5T7Y1B, REYQ8-REYQ12T7Y1B

REMQ5
REYQ8-12T

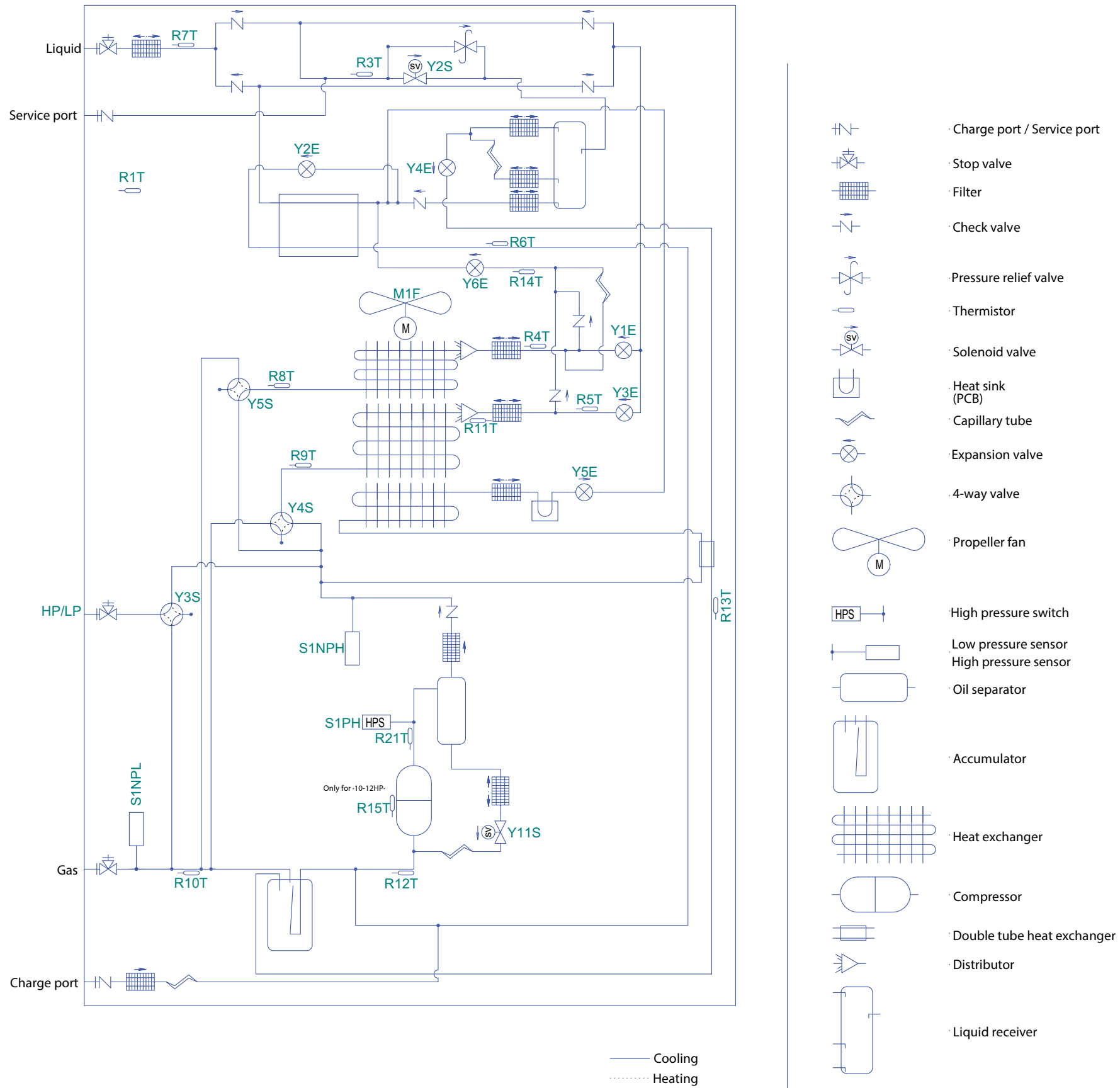

3D088100A

Figure 102 - Piping diagram REYQ14~REYQ20T7Y1B

REYQ14-20T

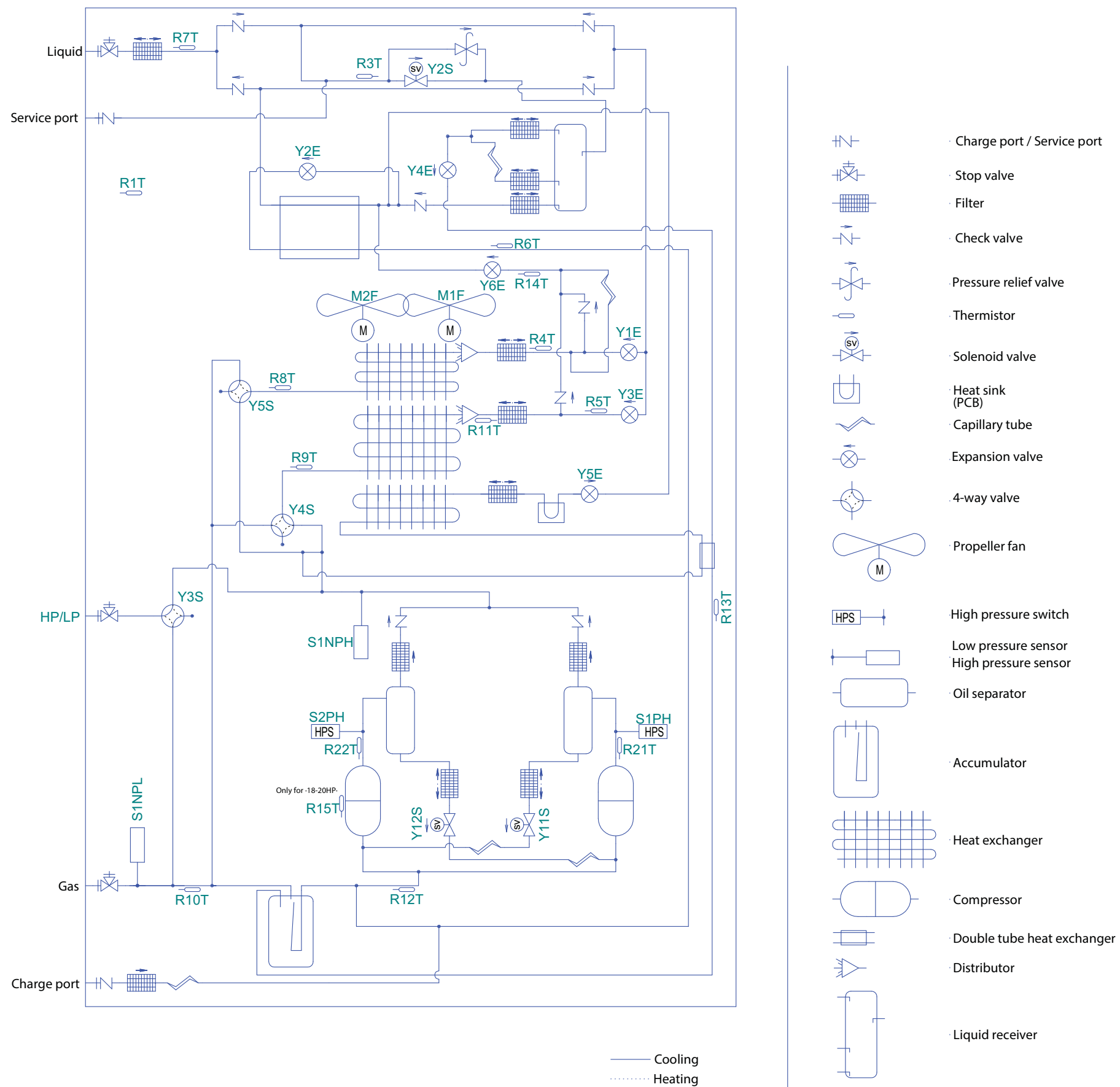

3D088099A

5. Piping overview

Figure 103 - Piping overview REMQ5T7Y1B, REYQ8~REYQ12T7Y1B

REMQ5T7Y1B and REYQ8~12T7Y1B

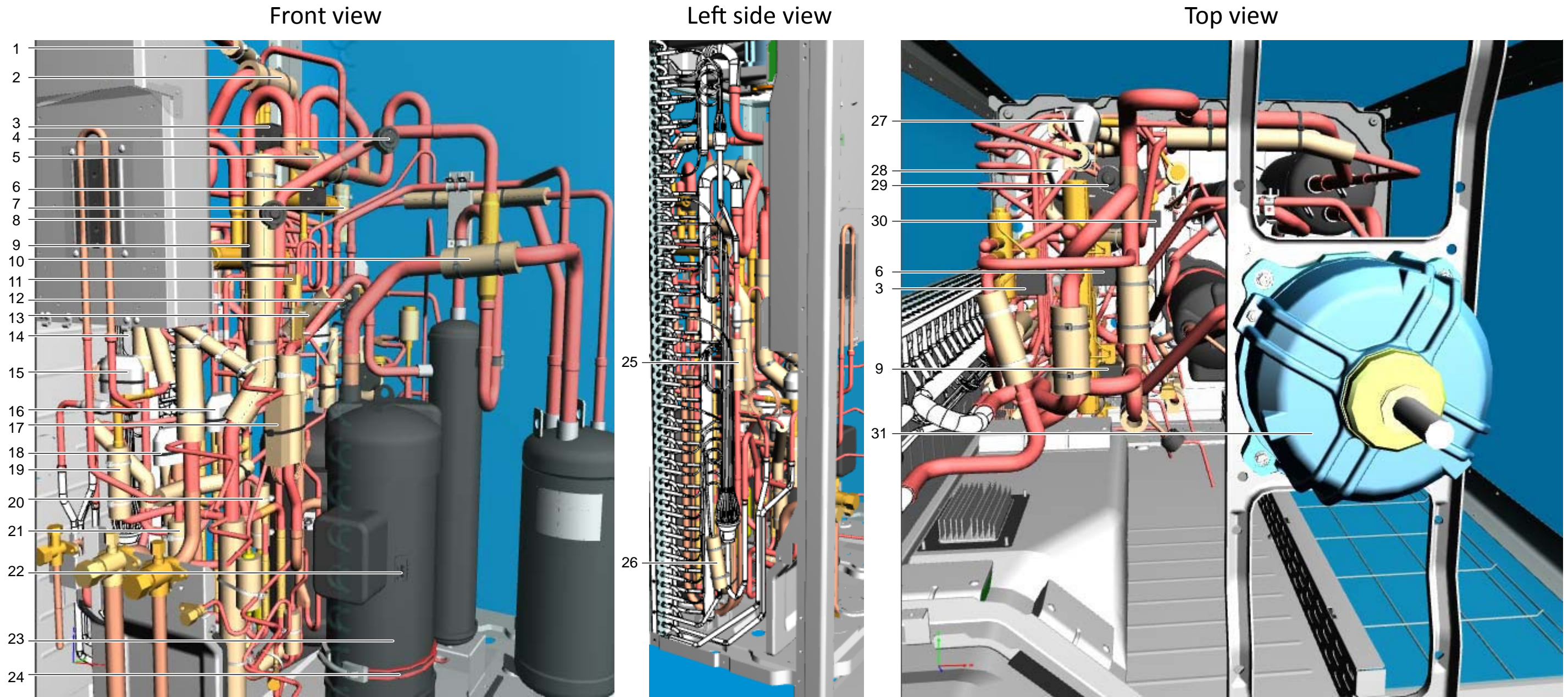

- | | | | |
|------------------------------------------|-------------------------------------------------|---------------------------------------------------|----------------|
| 1 Thermistor (Heat Exc. Gas Upper) (A1P) | 11 Pressure Switch (High) | 21 Thermistor (Heat Exc. Liq. Lower) (A1P) | 31 Motor (Fan) |
| 2 Thermistor (Heat Exc. Gas Lower) (A1P) | 12 Thermistor (Receiver Gas) (A8P) | 22 Thermistor (Compressor Body) (A1P) | |
| 3 Solenoid Valve (Heat Exc. Upper) | 13 Thermistor (Subcool Heat Exc. Gas) (A1P) | 23 Motor (Compressor) | |
| 4 Pressure Sensor (High) | 14 Thermistor (Air) (A1P) | 24 Crankcase Heater | |
| 5 Thermistor (Suction) (A1P) | 15 Electronic Expansion Valve (Auto Charge) | 25 Thermistor (Heat Exc. Liq. Upper) (A1P) | |
| 6 Solenoid Valve (Heat Exc. Lower) | 16 Electronic Expansion Valve (Heat Exc. Lower) | 26 Thermistor (Heat Exc. Deicer) (A8P) | |
| 7 Thermistor (Liq. Main) (A1P) | 17 Thermistor (M1C, M2C Discharge) (A1P) | 27 Electronic Expansion Valve (Receiver Gas) | |
| 8 Pressure Sensor (Low) | 18 Electronic Expansion Valve (Heat Exc. Upper) | 28 Electronic Expansion Valve (Inverter Cooling) | |
| 9 Solenoid Valve (HP/LP Gas Pipe) | 19 Thermistor (Auto Charge) (A8P) | 29 Electronic Expansion Valve (Subcool Heat Exc.) | |
| 10 Thermistor (Suction Compressor) (A8P) | 20 Thermistor (Subcool Heat Exc. Liq) (A1P) | 30 Solenoid Valve (Liq. Pipe) | |

Figure 104 - Piping overview REYQ14~REYQ20T7Y1B - part 1

REYQ14 ~20 T7Y1B

Top view including all panels

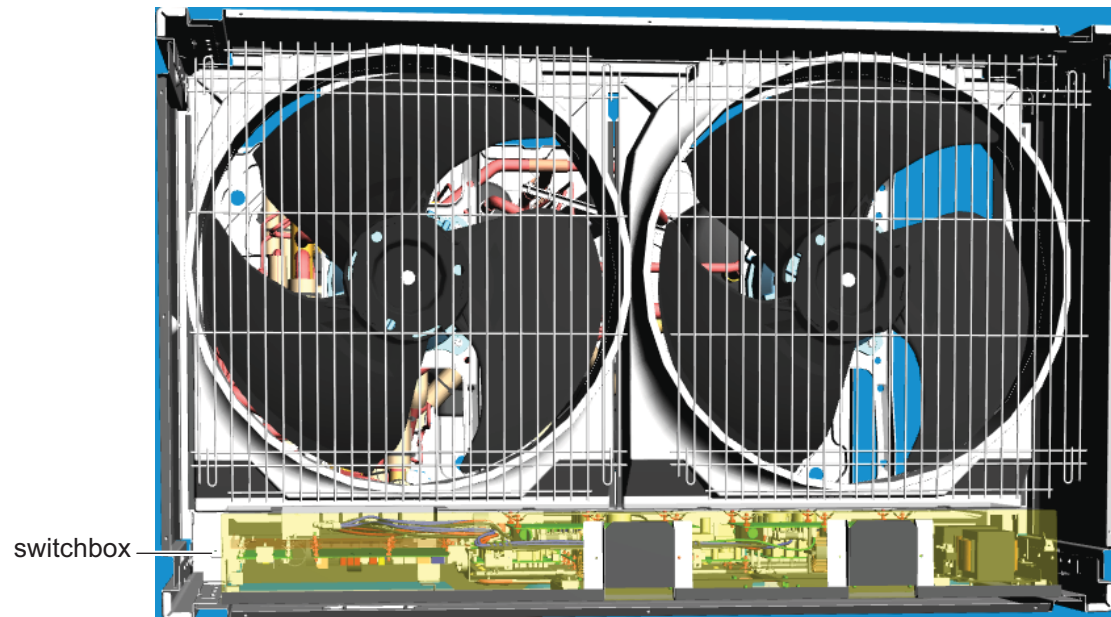

Top view after removing top panels, grills and propellers

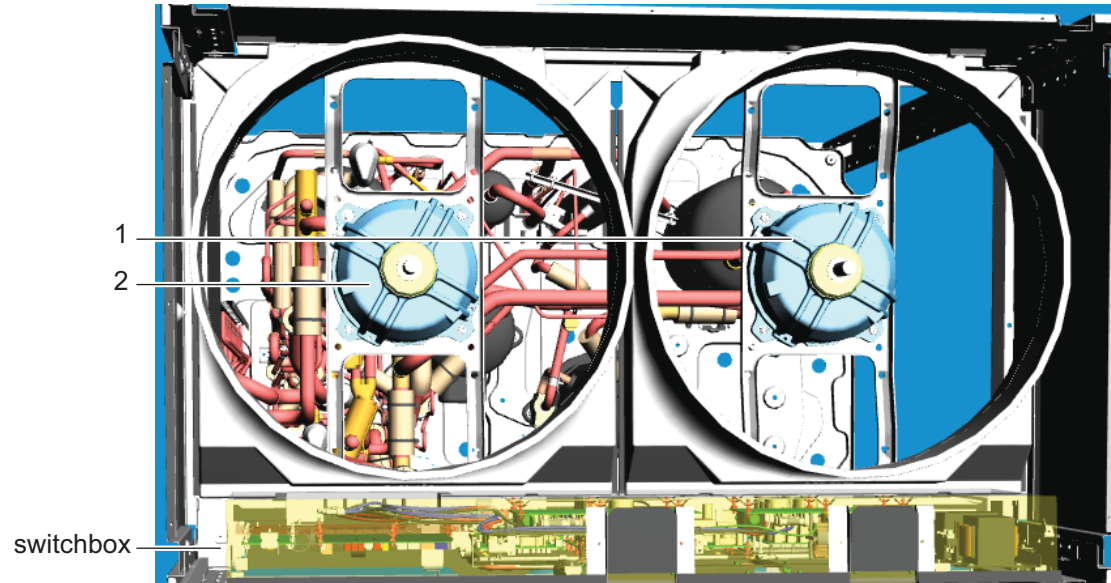

Left top view propeller and plate removed

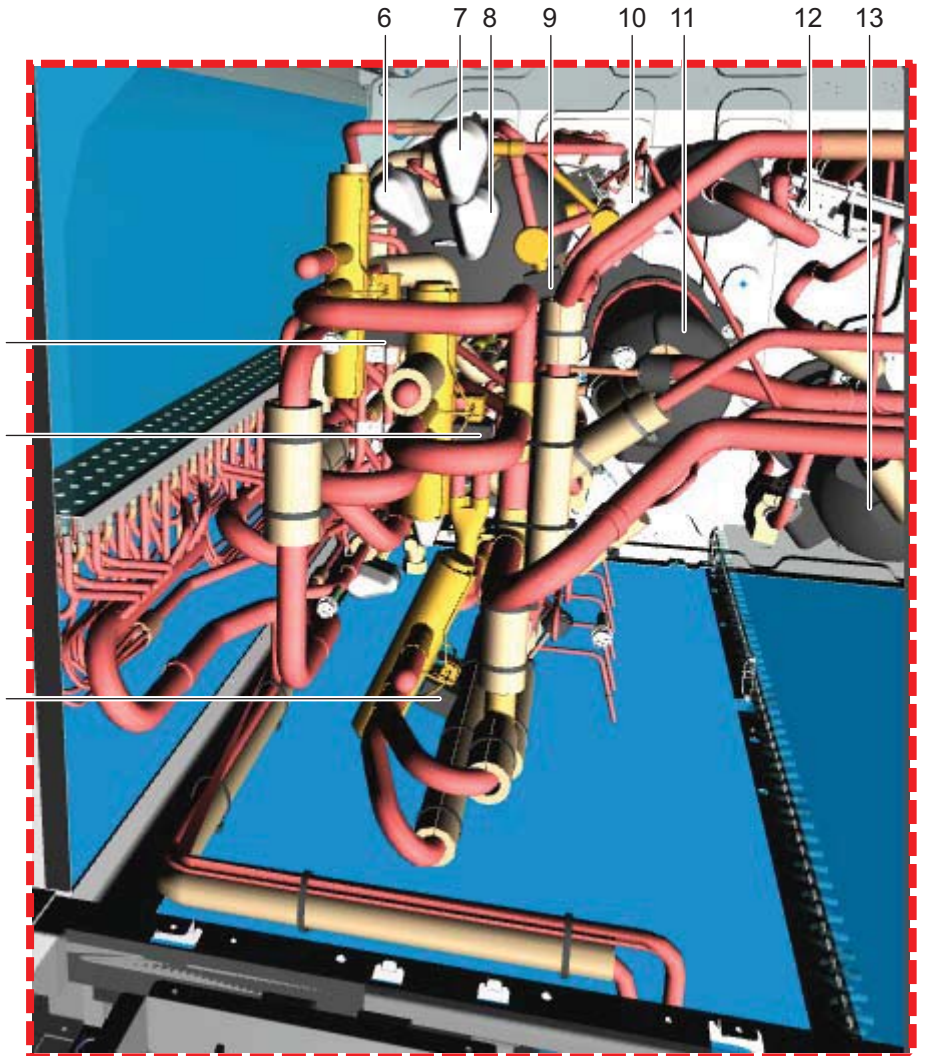
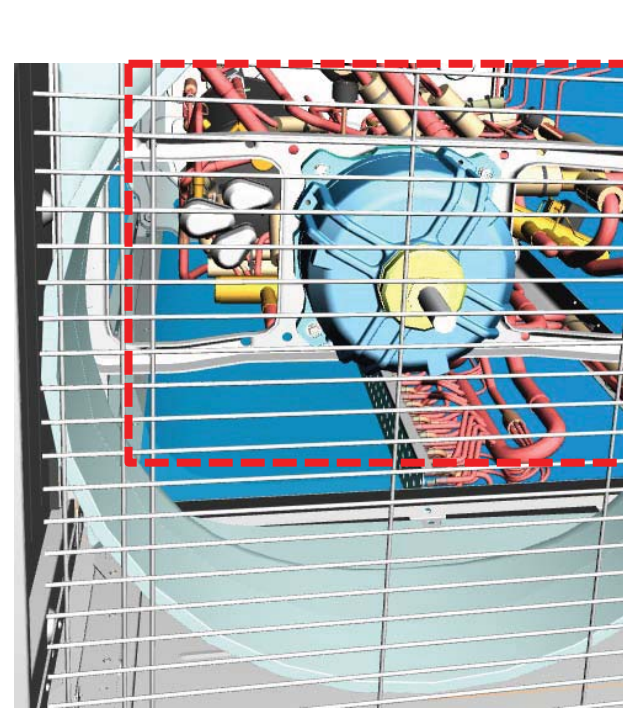

- | | |
|--------------------------------------------------|------------------------------------|
| 1 Motor (Fan) | 11 Motor (Compressor) |
| 2 Motor (Fan) | 12 Solenoid Valve (Oil Return M1C) |
| 3 Solenoid Valve (Heat Exc. Upper) | 13 Motor (Compressor) |
| 4 Solenoid Valve (Heat Exc. Lower) | |
| 5 Solenoid Valve (HP/LP Gas Pipe) | |
| 6 Electronic Expansion Valve (Receiver Gas) | |
| 7 Electronic Expansion Valve (Inverter Cooling) | |
| 8 Electronic Expansion Valve (Subcool Heat Exc.) | |
| 9 Solenoid Valve (Liq. Pipe) | |
| 10 Solenoid Valve (Oil Return M2C) | |

Figure 105 - Piping overview REYQ14~REYQ20T7Y1B - part 2

REYQ14 ~20 T7Y1B

Front view

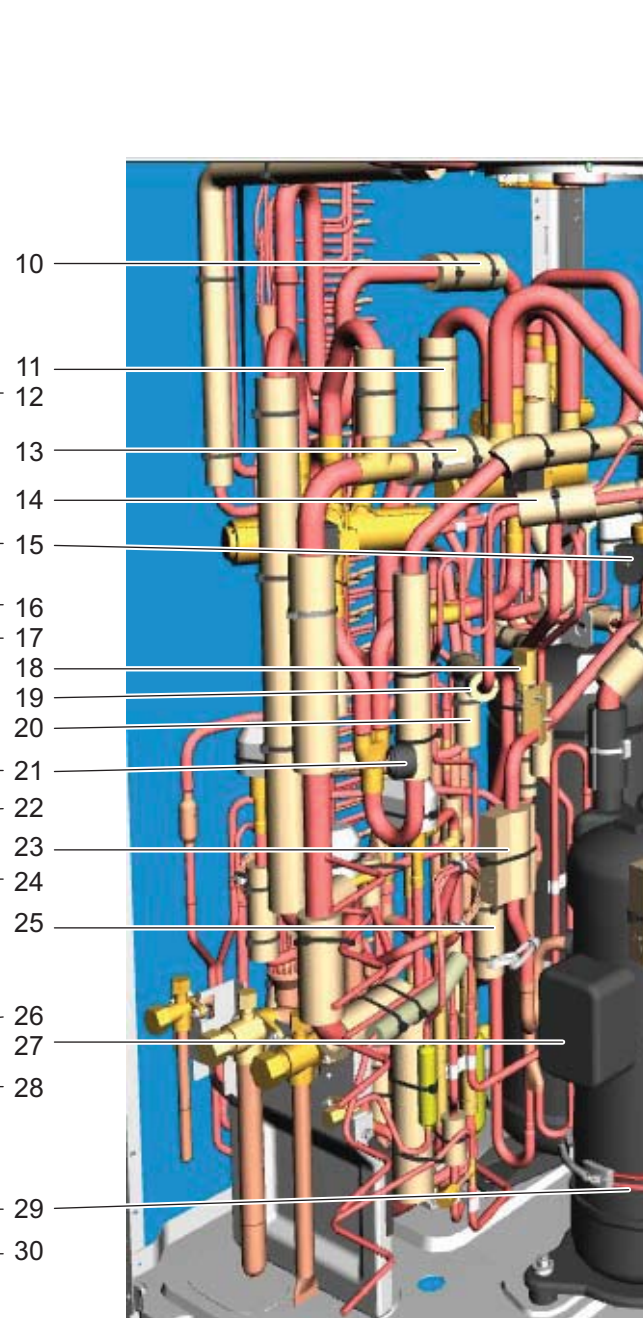
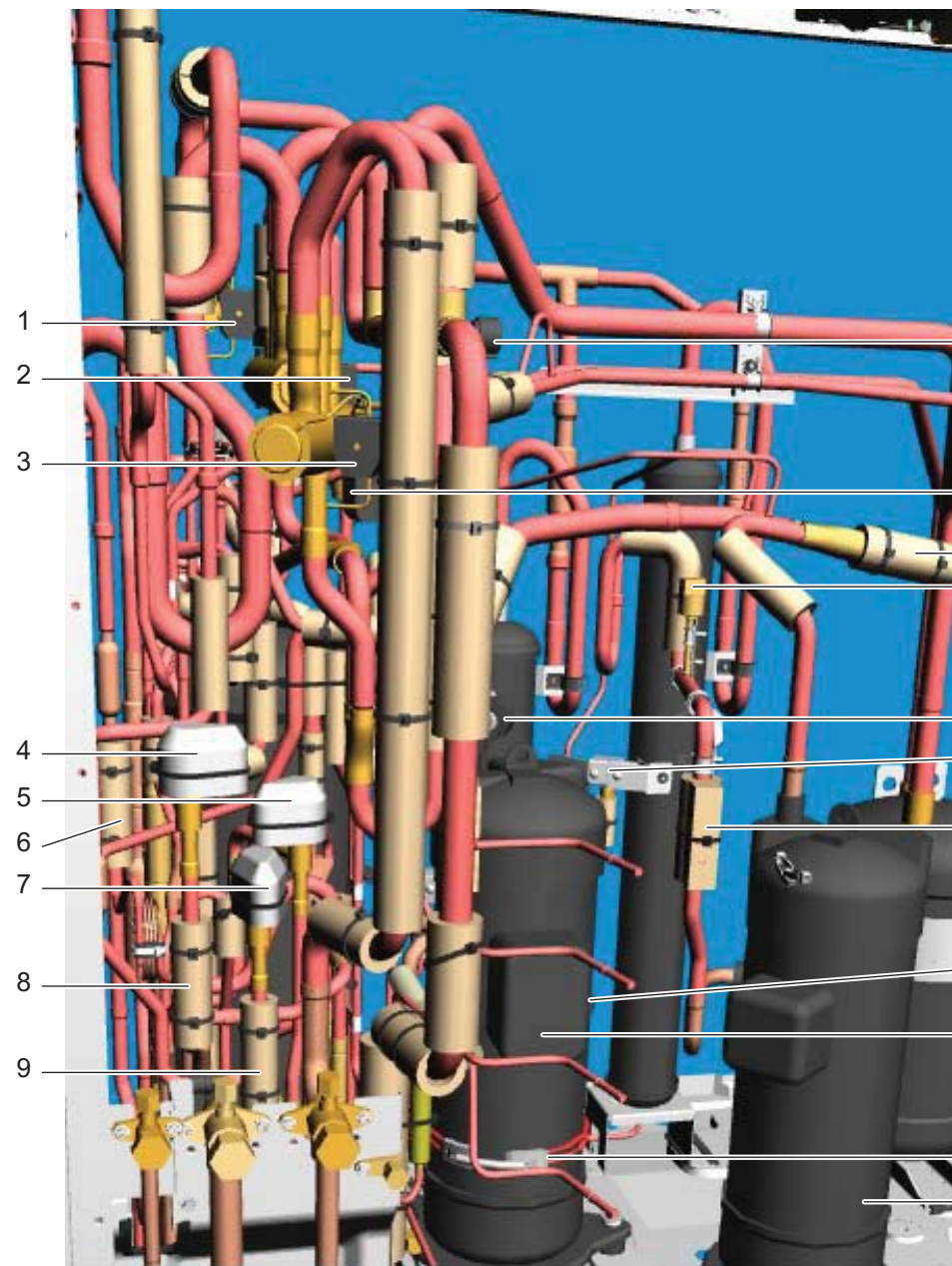

Left side view

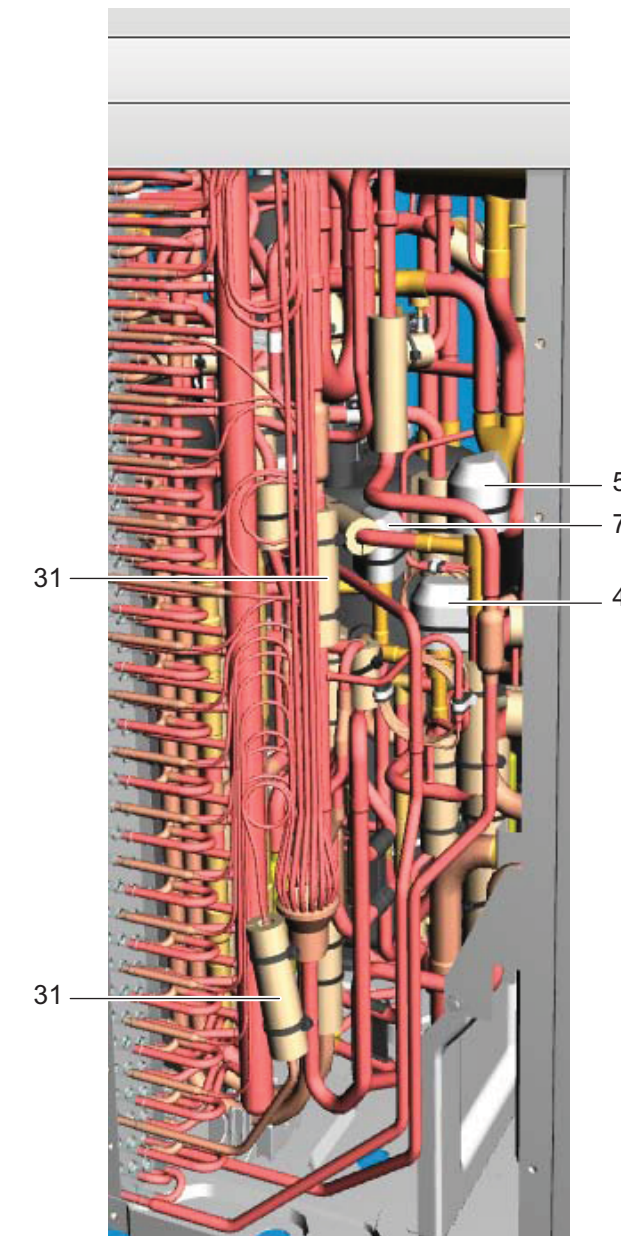

- | | | | |
|------------------------------------------------|---------------------------------------------|---------------------------------------------|----------------------------------------|
| 1 Solenoid Valve (Heat Exc. Lower) | 11 Thermistor (Heat Exc. Gas Lower) (A1P) | 21 Pressure Sensor (Low) | 31 Thermistor (Heat Exc. Deicer) (A8P) |
| 2 Solenoid Valve (Heat Exc. Upper) | 12 Pressure Sensor (High) | 22 Solenoid Valve (Oil Return M1C) | |
| 3 Solenoid Valve (HP/LP Gas Pipe) | 13 Thermistor (Suction) (A1P) | 23 Thermistor (M1C, M2C Discharge) (A1P) | |
| 4 Electronic Expansion Valve (Auto Charge) | 14 Thermistor (Receiver Gas) (A8P) | 24 Thermistor (M1C, M2C Discharge) (A1P) | |
| 5 Electronic Expansion Valve (Heat Exc. Upper) | 15 Solenoid Valve (Liq. Pipe) | 25 Thermistor (Subcool Heat Exc. Liq) (A1P) | |
| 6 Thermistor (Heat Exc. Liq. Upper) (A1P) | 16 Thermistor (Suction Compressor) (A8P) | 26 Thermistor (Compressor Body) (A1P) | |
| 7 Electronic Expansion Valve (Heat Exc. Lower) | 17 Pressure Switch (High) | 27 Motor (Compressor) | |
| 8 Thermistor (Auto Charge) (A8P) | 18 Pressure Switch (High) | 28 Motor (Compressor) | |
| 9 Thermistor (Heat Exc. Liq. Lower) (A1P) | 19 Thermistor (Subcool Heat Exc. Gas) (A1P) | 29 Crankcase Heater | |
| 10 Thermistor (Heat Exc. Gas Upper) (A1P) | 20 Thermistor (Liq. Main) (A1P) | 30 Crankcase Heater | |

In case a problem occurred on the unit which could not be resolved by using the content of this service manual or in case you have a problem which could be resolved but of which the manufacturer should be notified, we advise you to contact your distributor.

To facilitate the investigation, additional information is required. Please fill out the following form before contacting your distributor.

 FIELD INFORMATION REPORT

Key person info	
Name:	Company name:
Your contact details	
Phone number:	E-mail address:
Site address:	
Your reference:	Date of visit:

Claim info	
Title:	
Problem description:	
Error code:	Trouble date:
Problem frequency:	
Investigation steps done:	
Current situation (solved, not solved, ...):	
Countermeasures taken:	
Comments and proposals:	
Part available for return (if applicable):	

Application info

Application (house, apartment, office, ...):

New project or refurbishment:

Heat emitters (radiators / under floor heating / fan coils / ...):

Hydraulic layout (simple schematic):

Unit / Installation info

Model name:

Serial number:

Installation / commissioning date:

Software version hydro PCB:

Software version user interface:

Software version outdoor PCB:

Minimum water volume:

Maximum water volume:

Brine composition and mixture:

Brine freeze up temperature:

Space heating control (leaving water temperature, room thermostat, ext. room thermostat):

Space heating setpoint:

Domestic hot water control (reheat only, schedule only, reheat + schedule):

Domestic hot water setpoint:

Provide pictures of the field settings overview (viewable on the user interface).