

**DAIKIN**

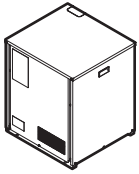

# Installation and operation manual

## VRV IV compressor unit for indoor installation



**RKXYQ5T8Y1B**  
**RKXYQ8T7Y1B**

Installation and operation manual  
VRV IV compressor unit for indoor installation

**English**









## Table of Contents

<b>1</b>	<b>About the documentation</b>	<b>6</b>	6.1.2	To access the field setting components	20
1.1	About this document	6	6.1.3	Field setting components	20
<b>For the installer</b>			6.1.4	To access mode 1 or 2	21
<b>2</b>	<b>About the box</b>	<b>6</b>	6.1.5	To use mode 1 (and default situation)	21
2.1	Compressor unit	6	6.1.6	To use mode 2	22
2.1.1	To remove the accessories from the compressor unit	6	6.1.7	Mode 1 (and default situation): Monitoring settings	22
2.1.2	To remove the transportation stay	7	6.1.8	Mode 2: Field settings	24
2.1.3	To remove the transportation EPS	7	6.1.9	To connect the PC configurator to the compressor unit	27
<b>3</b>	<b>About the units and options</b>	<b>7</b>	<b>7</b>	<b>Commissioning</b>	<b>27</b>
3.1	About the compressor unit and heat exchanger unit	7	7.1	Precautions when commissioning	27
3.2	System layout	7	7.2	Checklist before commissioning	27
3.3	Combining units and options	7	7.3	Checklist during commissioning	28
3.3.1	Possible options for the compressor unit and heat exchanger unit	7	7.3.1	About test run	28
<b>4</b>	<b>Preparation</b>	<b>8</b>	7.3.2	To perform a test run (7-LEDs display)	28
4.1	Preparing the installation site	8	7.3.3	To perform a test run (7-segments display)	28
4.1.1	Installation site requirements of the compressor unit	8	7.3.4	Correcting after abnormal completion of the test run	29
4.2	Preparing refrigerant piping	8	7.3.5	Operating the unit	29
4.2.1	Refrigerant piping requirements	8	<b>8</b>	<b>Troubleshooting</b>	<b>29</b>
4.2.2	Refrigerant piping material	8	8.1	Solving problems based on error codes	29
4.2.3	To select the piping size	9	8.1.1	Error codes: Overview	29
4.2.4	To select refrigerant branch kits	9	<b>9</b>	<b>Technical data</b>	<b>33</b>
4.2.5	Refrigerant piping length and height difference	10	9.1	Piping diagram: Compressor unit and heat exchanger unit	33
4.3	Preparing electrical wiring	10	9.2	Wiring diagram: Compressor unit	34
4.3.1	About electrical compliance	10	<b>For the user</b>		
4.3.2	Safety device requirements	10	<b>10</b>	<b>About the system</b>	<b>35</b>
<b>5</b>	<b>Installation</b>	<b>11</b>	10.1	System layout	35
5.1	Opening the units	11	<b>11</b>	<b>User interface</b>	<b>35</b>
5.1.1	To open the compressor unit	11	<b>12</b>	<b>Operation</b>	<b>35</b>
5.2	Mounting the compressor unit	11	12.1	Operation range	35
5.2.1	Guidelines when installing the compressor unit	11	12.2	Operating the system	35
5.3	Connecting the refrigerant piping	11	12.2.1	About operating the system	35
5.3.1	Using the stop valve and service port	11	12.2.2	About cooling, heating, fan only, and automatic operation	36
5.3.2	To remove the pinched pipes	12	12.2.3	About the heating operation	36
5.3.3	To connect the refrigerant piping to the compressor unit	13	12.2.4	To operate the system (WITHOUT cool/heat changeover remote control switch)	36
5.4	Checking the refrigerant piping	14	12.2.5	To operate the system (WITH cool/heat changeover remote control switch)	36
5.4.1	About checking the refrigerant piping	14	12.3	Using the dry program	36
5.4.2	Checking refrigerant piping: General guidelines	14	12.3.1	About the dry program	36
5.4.3	Checking refrigerant piping: Setup	14	12.3.2	To use the dry program (WITHOUT cool/heat changeover remote control switch)	37
5.4.4	To perform a leak test	15	12.3.3	To use the dry program (WITH cool/heat changeover remote control switch)	37
5.4.5	To perform vacuum drying	15	12.4	Adjusting the air flow direction	37
5.5	To insulate the refrigerant piping	15	12.4.1	About the air flow flap	37
5.6	Charging refrigerant	16	12.5	Setting the master user interface	37
5.6.1	Precautions when charging refrigerant	16	12.5.1	About setting the master user interface	37
5.6.2	To determine the additional refrigerant amount	16	12.5.2	To designate the master user interface (VRV DX)	38
5.6.3	To charge refrigerant	16	<b>13</b>	<b>Maintenance and service</b>	<b>38</b>
5.6.4	Error codes when charging refrigerant	17	13.1	About the refrigerant	38
5.6.5	To fix the fluorinated greenhouse gases label	17	13.2	After-sales service and warranty	38
5.7	Connecting the electrical wiring	18	13.2.1	Warranty period	38
5.7.1	Field wiring: Overview	18	13.2.2	Recommended maintenance and inspection	38
5.7.2	Guidelines when connecting the electrical wiring	18	<b>14</b>	<b>Troubleshooting</b>	<b>39</b>
5.7.3	To connect the electrical wiring on the compressor unit	18	14.1	Error codes: Overview	39
5.8	Finishing the compressor unit installation	19	14.2	Symptoms that are NOT system malfunctions	40
5.8.1	To finish the transmission wiring	19	14.2.1	Symptom: The system does not operate	40
<b>6</b>	<b>Configuration</b>	<b>19</b>	14.2.2	Symptom: Cool/Heat cannot be changed over	40
6.1	Making field settings	19	14.2.3	Symptom: Fan operation is possible, but cooling and heating do not work	40
6.1.1	About making field settings	19			

# 1 About the documentation

14.2.4	Symptom: The fan strength does not correspond to the setting .....	40
14.2.5	Symptom: The fan direction does not correspond to the setting .....	40
14.2.6	Symptom: White mist comes out of a unit (Indoor unit) .....	40
14.2.7	Symptom: White mist comes out of a unit (Indoor unit, heat exchanger unit) .....	41
14.2.8	Symptom: The user interface display reads "U4" or "U5" and stops, but then restarts after a few minutes. ....	41
14.2.9	Symptom: Noise of air conditioners (Indoor unit, heat exchanger unit) .....	41
14.2.10	Symptom: Noise of air conditioners (Indoor unit, compressor unit, heat exchanger unit).....	41
14.2.11	Symptom: Noise of air conditioners (compressor unit, heat exchanger unit) .....	41
14.2.12	Symptom: Dust comes out of the heat exchanger unit .....	41
14.2.13	Symptom: The units can give off odours.....	41
14.2.14	Symptom: The heat exchanger unit fan does not spin .....	41
14.2.15	Symptom: The display shows "88".....	41
14.2.16	Symptom: The compressor in the compressor unit does not stop after a short heating operation .....	41
14.2.17	Symptom: The inside of a compressor unit is warm even when the unit has stopped .....	41
14.2.18	Symptom: Hot air can be felt when the indoor unit is stopped .....	41

**15 Relocation** **41**

**16 Disposal** **41**

## 1 About the documentation

### 1.1 About this document

#### Target audience

Authorised installers + end users

#### **i** INFORMATION

This appliance is intended to be used by expert or trained users in shops, in light industry and on farms, or for commercial use by lay persons.

#### Documentation set

This document is part of a documentation set. The complete set consists of:

- **General safety precautions:**
  - Safety instructions that you must read before installing
  - Format: Paper (in the accessory bag of the compressor unit)
- **Compressor unit installation and operation manual:**
  - Installation and operation instructions
  - Format: Paper (in the accessory bag of the compressor unit)
- **Heat exchanger unit installation manual:**
  - Installation instructions
  - Format: Paper (in the accessory bag of the heat exchanger unit)
- **Installer and user reference guide:**
  - Preparation of the installation, reference data,...
  - Detailed step-by-step instructions and background information for basic and advanced usage
  - Format: Digital files on <http://www.daikineurope.com/support-and-manuals/product-information/>

Latest revisions of the supplied documentation may be available on the regional Daikin website or via your dealer.

The original documentation is written in English. All other languages are translations.

#### Technical engineering data

- A **subset** of the latest technical data is available on the regional Daikin website (publicly accessible).
- The **full set** of latest technical data is available on the Daikin extranet (authentication required).

## For the installer

## 2 About the box

### 2.1 Compressor unit

#### 2.1.1 To remove the accessories from the compressor unit

1 Remove the accessories (part 1).

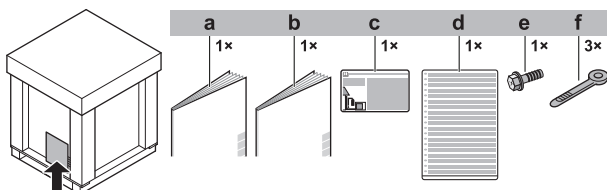

- a General safety precautions
- b Compressor unit installation and operation manual
- c Fluorinated greenhouse gases label
- d Multilingual fluorinated greenhouse gases label
- e Screw (only needed in case 5 HP for shield of transmission wiring) (see "5.7.3 To connect the electrical wiring on the compressor unit" on page 18)
- f Cable tie

- 2 Remove the service cover. See "5.1.1 To open the compressor unit" on page 11.
- 3 Remove the accessories (part 2).

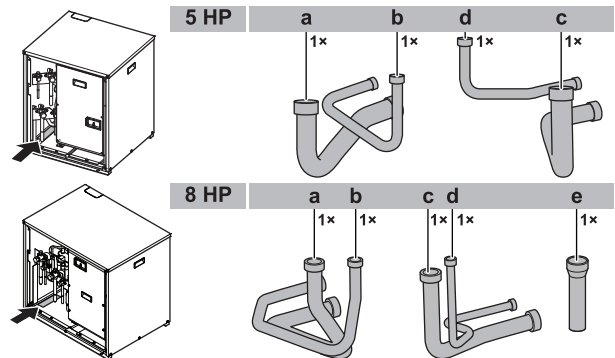

a+b Piping accessories for circuit 1 (to the heat exchanger unit)

		5 HP	8 HP
a	Gas	Ø19.1 mm	Ø22.2 mm
b	Liquid	Ø12.7 mm	Ø12.7 mm

c+d Piping accessories for circuit 2 (to the indoor units)

### 3 About the units and options

		5 HP	8 HP
c	Gas	Ø15.9 mm	Ø19.1 mm
d	Liquid	Ø9.5 mm	Ø9.5 mm

- e Piping adapter (Ø19.1→22.2 mm) that you need when connecting piping to the heat exchanger unit (only for 8 HP)

#### 2.1.2 To remove the transportation stay

Only for RKXYQ5.



#### NOTICE

If the unit is operated with the transportation stay attached, abnormal vibration or noise may be generated.

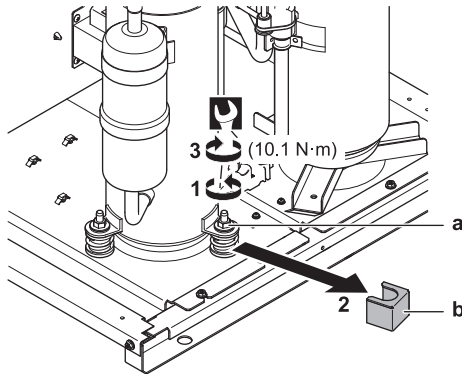

#### 2.1.3 To remove the transportation EPS

Only for RKXYQ8.

Remove the EPS. The EPS protects the unit during transport.

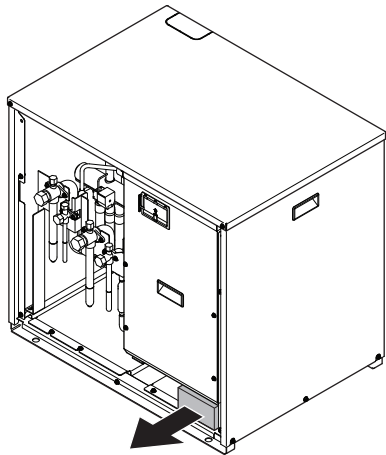

## 3 About the units and options

### 3.1 About the compressor unit and heat exchanger unit

The compressor unit and heat exchanger unit are intended for indoor installation and aimed for air to air heat pump applications.

Specification		5 HP	8 HP
Maximum capacity	Heating	16.0 kW	25.0 kW
	Cooling	14.0 kW	22.4 kW
Outside ambient design temperature	Heating	-20~15.5°C WB	
	Cooling	-5~46°C DB	

Specification		5 HP	8 HP
Ambient design temperature of compressor unit and heat exchanger unit		5~35°C DB	
Maximum relative humidity around the compressor unit and heat exchanger unit	Heating	50% <sup>(a)</sup>	
	Cooling	80% <sup>(a)</sup>	

- (a) To avoid condensation and water dripping out of the unit. If the temperature or the humidity is beyond these conditions, safety devices may be put in action and the air conditioner may not operate.

### 3.2 System layout



#### NOTICE

Design of the system must not be done at temperatures below -15°C.

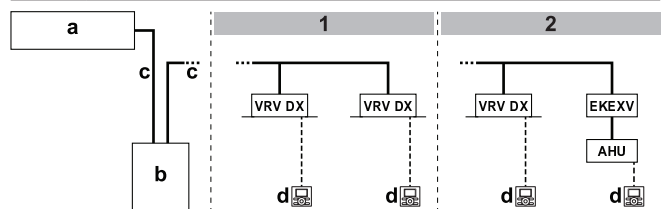

- 1 In case of VRV DX indoor units  
 2 In case of VRV DX indoor units combined with an air handling unit  
 a Heat exchanger unit  
 b Compressor unit  
 c Refrigerant piping  
 d User interface (dedicated depending on indoor unit type)  
 VRV DX VRV direct expansion (DX) indoor unit  
 EKEXV Expansion valve kit  
 AHU Air handling unit

### 3.3 Combining units and options

#### 3.3.1 Possible options for the compressor unit and heat exchanger unit

For more possible options, see the installer and user reference guide.

#### Cool/heat selector

In order to control the cooling or heating operation from a central location, the following option can be connected:

Description	5 HP	8 HP
Cool/heat selector switch	KRC19-26A	
Cool/heat selector cable	EKCHSC	—
Cool/heat selector PCB	—	BRP2A81 <sup>(a)</sup>
With optional fixing box for the switch	KJB111A	

- (a) To install BRP2A81, proceed as follows:

- 1 Check the components of BRP2A81. You do NOT need all of them.

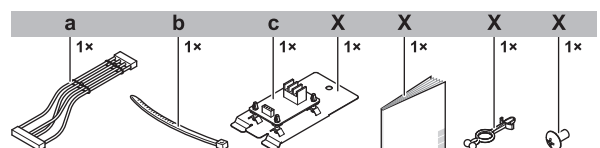

- a Cable  
 b Cable tie  
 c PCB  
 X Not needed

- 2 Remove the mounting plate from the PCB.



## 4 Preparation

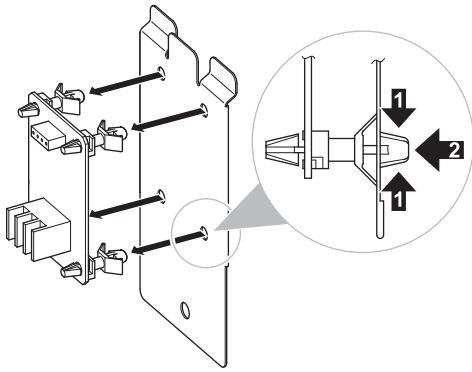

3 Mount the PCB.

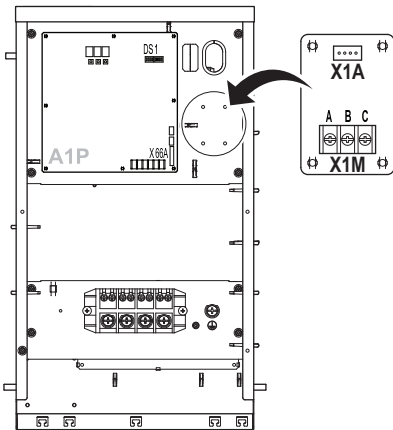

4 Connect the cable.

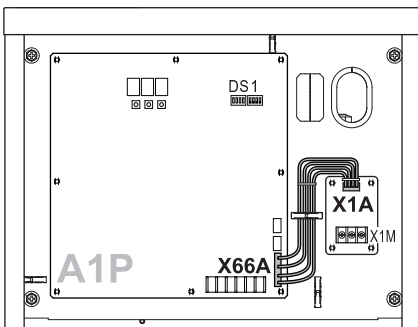

5 Connect the cool/heat selector switch. Tightening torque X1M (A/B/C): 0.53~0.63 N•m

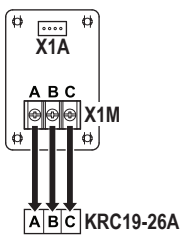

6 Fix the cables with cable ties.

7 Turn ON the DIP switch (DS1-1).

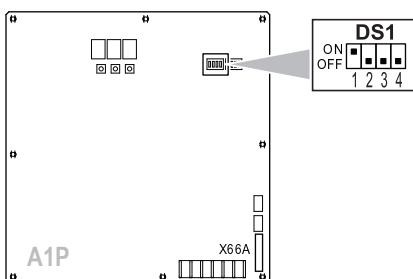

8 Perform a test run. See the "Commissioning" chapter.

## 4 Preparation

### 4.1 Preparing the installation site

#### 4.1.1 Installation site requirements of the compressor unit

• **Service space.** Mind the following requirements:

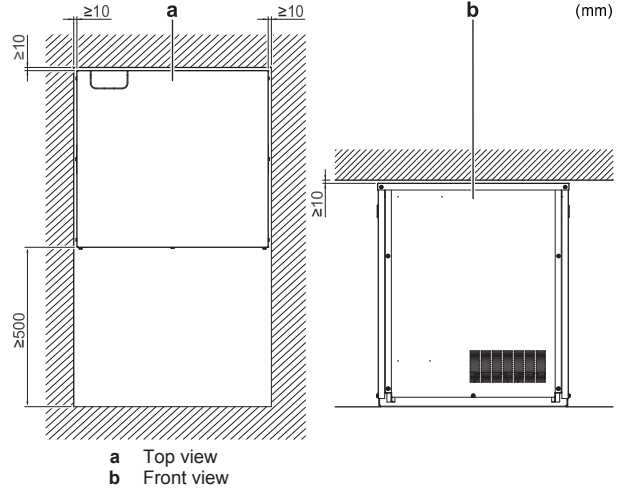

#### CAUTION

Appliance not accessible to the general public, install it in a secured area, protected from easy access.

These units (compressor unit, heat exchanger unit and indoor units) are suitable for installation in a commercial and light industrial environment.



#### NOTICE

This is a class A product. In a domestic environment this product may cause radio interference in which case the user may be required to take adequate measures.

### 4.2 Preparing refrigerant piping

#### 4.2.1 Refrigerant piping requirements



#### NOTICE

Refrigerant R410A requires strict cautions for keeping the system clean and dry. Foreign materials (including mineral oils or moisture) should be prevented from getting mixed into the system.



#### NOTICE

The piping and other pressure-containing parts shall be suitable for refrigerant. Use phosphoric acid deoxidised seamless copper for refrigerant.

• Foreign materials inside pipes (including oils for fabrication) must be  $\leq 30$  mg/10 m.

#### 4.2.2 Refrigerant piping material

- **Piping material:** Phosphoric acid deoxidised seamless copper.
- **Piping temper grade and thickness:**



Outer diameter (Ø)	Temper grade	Thickness (t) <sup>(a)</sup>	
6.4 mm (1/4")	Annealed (O)	≥0.80 mm	
9.5 mm (3/8")			
12.7 mm (1/2")			
15.9 mm (5/8")	Annealed (O)	≥0.99 mm	
19.1 mm (3/4")	Half hard (1/2H)	≥0.80 mm	
22.2 mm (7/8")			

(a) Depending on the applicable legislation and the unit's maximum working pressure (see "PS High" on the unit name plate), larger piping thickness might be required.

### 4.2.3 To select the piping size

Determine the proper size using the following tables and reference figure (only for indication).

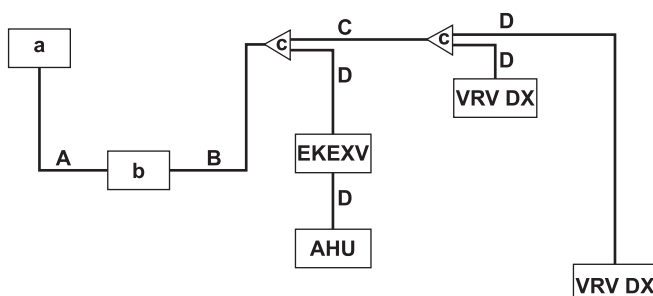

- a Heat exchanger unit
- b Compressor unit
- c Refrigerant branch kit
- VRV DX VRV DX indoor unit
- EKEXV Expansion valve kit
- AHU Air handling unit
- A Piping between heat exchanger unit and compressor unit
- B Piping between compressor unit and (first) refrigerant branch kit (= main pipe)
- C Piping between refrigerant branch kits
- D Piping between refrigerant branch kit and indoor unit

In case the required pipe sizes (inch sizes) are not available, it is also allowed to use other diameters (mm sizes), taken the following into account:

- Select the pipe size nearest to the required size.
- Use the suitable adapters for the change-over from inch to mm pipes (field supply).
- The additional refrigerant calculation has to be adjusted as mentioned in "5.6.2 To determine the additional refrigerant amount" on page 16.

#### A: Piping between heat exchanger unit and compressor unit

Use the following diameters:

Compressor unit capacity type	Piping outer diameter size (mm)	
	Gas pipe	Liquid pipe
5 HP	19.1	12.7
8 HP	22.2	

#### B: Piping between compressor unit and first refrigerant branch kit

Use the following diameters:

Compressor unit capacity type	Piping outer diameter size (mm)			
	Gas pipe		Liquid pipe	
	Standard	Size-up	Standard	Size-up
5 HP	15.9	19.1	9.5	—
8 HP	19.1	22.2	9.5	12.7

Standard ↔ Size-up:

If	Then
The equivalent pipe length between the heat exchanger unit and the furthest indoor unit is 90 m or more	<p>5 HP It is <b>recommended to increase</b> the size (size-up) of the <b>main gas pipe</b> (between compressor unit and first refrigerant branch kit). If the recommended gas pipe (size-up) is not available, you must use the standard size (which might result in a small capacity decrease).</p> <p>8 HP</p> <ul style="list-style-type: none"> <li>▪ You <b>must increase</b> the size (size-up) of the <b>main liquid pipe</b> (between compressor unit and first refrigerant branch kit).</li> <li>▪ It is <b>recommended to increase</b> the size (size-up) of the <b>main gas pipe</b> (between compressor unit and first refrigerant branch kit). If the recommended gas pipe (size-up) is not available, you must use the standard size (which might result in a small capacity decrease).</li> </ul>

#### C: Piping between refrigerant branch kits

Use the following diameters:

Indoor unit capacity index	Piping outer diameter size (mm)	
	Gas pipe	Liquid pipe
<150	15.9	9.5
150 ≤ x < 200	19.1	
200 ≤ x < 260	22.2	

#### D: Piping between refrigerant branch kit and indoor unit

Use the same diameters as the connections (liquid, gas) on the indoor units. The diameters of the indoor units are as follows:

Indoor unit capacity index	Piping outer diameter size (mm)	
	Gas pipe	Liquid pipe
15~50	12.7	6.4
63~140	15.9	9.5
200	19.1	
250	22.2	

### 4.2.4 To select refrigerant branch kits

For piping example, refer to "4.2.3 To select the piping size" on page 9.

#### Refnet joint at first branch (counting from the compressor unit)

When using refnet joints at the first branch counted from the compressor unit side, choose from the following table in accordance with the capacity of the compressor unit. **Example:** Refnet joint c (B→C/D).

Compressor unit capacity type	Refrigerant branch kit
5 HP	KHRQ22M20T
8 HP	KHRQ22M29T9

#### Refnet joints at other branches

For refnet joints other than the first branch, select the proper branch kit model based on the total capacity index of all indoor units connected after the refrigerant branch. **Example:** Refnet joint c (C→D/D).

## 4 Preparation

Indoor unit capacity index	Refrigerant branch kit
<200	KHRQ22M20T
200≤x<260	KHRQ22M29T9

### Refnet headers

Concerning refnet headers, choose from the following table in accordance with the total capacity of all the indoor units connected below the refnet header.

Indoor unit capacity index	Refrigerant branch kit
<260	KHRQ22M29H



### INFORMATION

Maximum 8 branches can be connected to a header.

### 4.2.5 Refrigerant piping length and height difference

The piping lengths and height differences must comply with the following requirements.

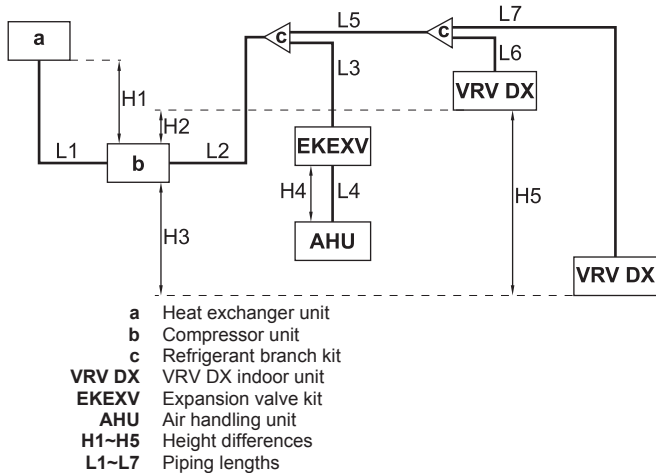

Minimum and maximum piping lengths																							
1	Heat exchanger unit → Compressor unit	L1≤30 m																					
2	Actual piping length (equivalent piping length) <sup>(a)</sup>	L2+L3+L4≤70 m (90 m) L2+L5+L6≤70 m (90 m) L2+L5+L7≤70 m (90 m)																					
3	Total piping length (x=L1+L2+L3+L4+L5+L6+L7)	<table border="1"> <tr> <td>Minimum</td> <td colspan="2">10 m≤x</td> </tr> <tr> <td>Maximum in case of 8 HP</td> <td colspan="2">x≤300 m</td> </tr> <tr> <td rowspan="6">Maximum in case of 5 HP</td> <td><b>If</b></td> <td><b>Then</b></td> </tr> <tr> <td>L1≤30 m</td> <td>x≤115 m</td> </tr> <tr> <td>L1≤25 m</td> <td>x≤120 m</td> </tr> <tr> <td>L1≤20 m</td> <td>x≤125 m</td> </tr> <tr> <td>L1≤15 m</td> <td>x≤130 m</td> </tr> <tr> <td>L1≤10 m</td> <td>x≤135 m</td> </tr> <tr> <td>L1≤5 m</td> <td>x≤140 m</td> </tr> </table>	Minimum	10 m≤x		Maximum in case of 8 HP	x≤300 m		Maximum in case of 5 HP	<b>If</b>	<b>Then</b>	L1≤30 m	x≤115 m	L1≤25 m	x≤120 m	L1≤20 m	x≤125 m	L1≤15 m	x≤130 m	L1≤10 m	x≤135 m	L1≤5 m	x≤140 m
Minimum	10 m≤x																						
Maximum in case of 8 HP	x≤300 m																						
Maximum in case of 5 HP	<b>If</b>	<b>Then</b>																					
	L1≤30 m	x≤115 m																					
	L1≤25 m	x≤120 m																					
	L1≤20 m	x≤125 m																					
	L1≤15 m	x≤130 m																					
	L1≤10 m	x≤135 m																					
L1≤5 m	x≤140 m																						
4	EKEXV → AHU	L4≤5 m																					
5	First branch kit → Indoor unit/AHU	L3+L4≤40 m L5+L6≤40 m L5+L7≤40 m																					
Maximum height differences <sup>(b)</sup>																							
1	Heat exchanger unit ↔ Compressor unit	H1≤10 m																					

2	Compressor unit ↔ Indoor unit	H2≤30 m H3≤30 m
3	EKEXV ↔ AHU	H4≤5 m
4	Indoor unit ↔ Indoor unit	H5≤15 m

- (a) Assume equivalent piping length of refnet joint=0.5 m and refnet header=1 m (for calculation purposes of equivalent piping length, not for refrigerant charge calculations).  
 (b) Either unit can be the highest unit.

## 4.3 Preparing electrical wiring

### 4.3.1 About electrical compliance

#### Only for RKXYQ8

This equipment complies with:

- EN/IEC 61000-3-12 provided that the short-circuit power  $S_{sc}$  is greater than or equal to the minimum  $S_{sc}$  value at the interface point between the user's supply and the public system.
- EN/IEC 61000-3-12 = European/International Technical Standard setting the limits for harmonic currents produced by equipment connected to public low-voltage systems with input current >16 A and ≤75 A per phase.
- It is the responsibility of the installer or user of the equipment to ensure, by consultation with the distribution network operator if necessary, that the equipment is connected only to a supply with a short-circuit power  $S_{sc}$  greater than or equal to the minimum  $S_{sc}$  value.

Model	Minimum $S_{sc}$ value
RKXYQ8	3329 kVA

### 4.3.2 Safety device requirements



#### NOTICE

When using residual current operated circuit breakers, be sure to use a high-speed type 300 mA rated residual operating current.

#### Power supply: Compressor unit

The power supply must be protected with the required safety devices, i.e. a main switch, a slow blow fuse on each phase and an earth leakage protector in accordance with the applicable legislation.

Selection and sizing of the wiring should be done in accordance with the applicable legislation based on the information mentioned in the table below.

Model	Minimum circuit ampacity	Recommended fuses
RKXYQ5	13.5 A	16 A
RKXYQ8	17.4 A	20 A

- Phase and frequency: 3N~ 50 Hz
- Voltage: 380-415 V

#### Transmission wiring

Transmission line section:

Transmission wiring	Sheathed + shielded cable (2 wires) Vinyl cords 0.75~1.25 mm <sup>2</sup> (using shielded cable for the transmission wiring is mandatory for 5 HP, and optional for 8 HP)
---------------------	--

Maximum wiring length (= distance between compressor unit and furthest indoor unit)	300 m
Total wiring length (= distance between compressor unit and all indoor units, and between compressor unit and heat exchanger unit)	600 m

If the total transmission wiring exceeds these limits, it may result in communication error.

## 5 Installation

### 5.1 Opening the units

#### 5.1.1 To open the compressor unit



**DANGER: RISK OF BURNING**



**DANGER: RISK OF ELECTROCUTION**

- 1 Remove the service cover of the compressor unit.

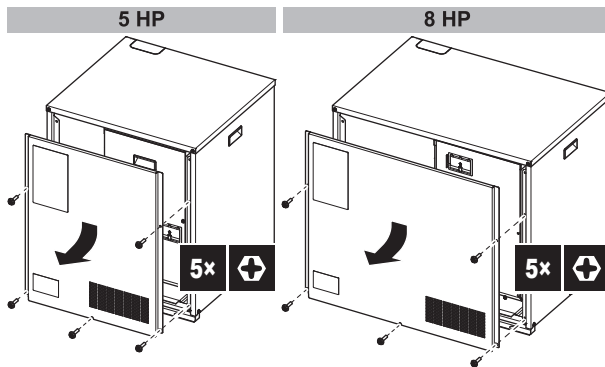

- 2 If you want to make **field settings**, remove the inspection cover.

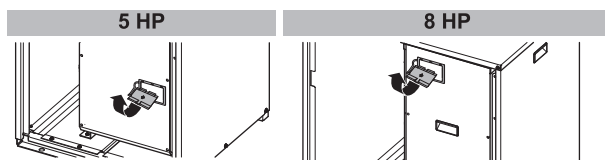

- 3 If you want to connect **electrical wiring**, remove the switch box cover.

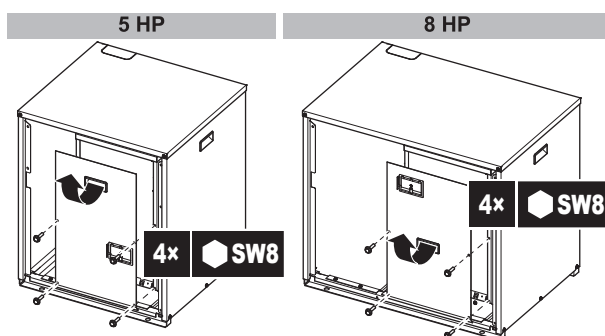

### 5.2 Mounting the compressor unit

#### 5.2.1 Guidelines when installing the compressor unit

Check the strength and level of the installation ground so that the unit will not cause any operating vibration or noise. If the vibration might be transmitted to the building, use a vibration-proof rubber (field supply).

You can install the compressor unit directly on the floor or on a structure.

- **On the floor.** You do NOT have to fix the unit with anchor bolts.
- **On a structure.** Fix the unit securely with anchor bolts, nuts and washers (field supply) to the structure. The foundation (steel beam frame or concrete) must be larger than the grey marked area.

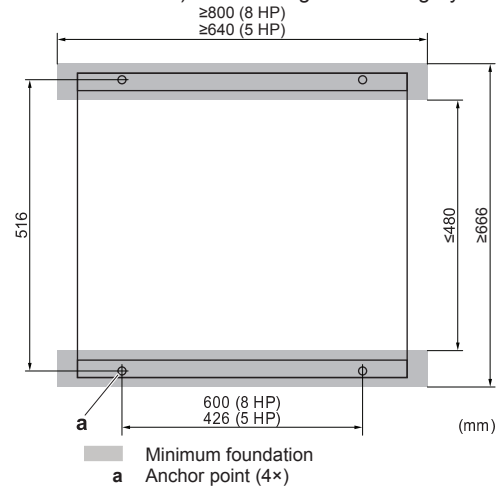

#### INFORMATION

The recommended height of the upper protruding part of the bolts is 20 mm.

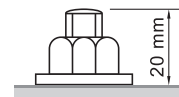

### 5.3 Connecting the refrigerant piping



**DANGER: RISK OF BURNING**

#### 5.3.1 Using the stop valve and service port

##### To handle the stop valve

- Make sure to keep all stop valves open during operation.
- The stop valve is factory closed.

##### To open the stop valve

- 1 Remove the stop valve cover.
- 2 Insert a hexagon wrench into the stop valve and turn the stop valve counterclockwise.
- 3 When the stop valve cannot be turned any further, stop turning.

**Result:** The valve is now open.

To fully open the  $\varnothing 19.1$  mm stop valve, turn the hexagonal wrench until a torque between 27 and 33 N·m is achieved.

Inadequate torque may cause leakage of refrigerant and breakage of the stop valve cap.

## 5 Installation

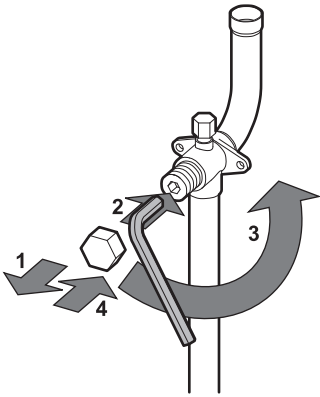

### NOTICE

Pay attention that mentioned torque range is applicable for opening  $\varnothing 19.1$  mm stop valves only.

### To close the stop valve

- 1 Remove the stop valve cover.
- 2 Insert a hexagon wrench into the stop valve and turn the stop valve clockwise.
- 3 When the stop valve cannot be turned any further, stop turning.

**Result:** The valve is now closed.

Closing direction:

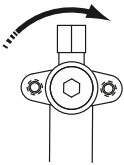

### To handle the stop valve cover

- The stop valve cover is sealed where indicated by the arrow. Do NOT damage it.
- After handling the stop valve, tighten the stop valve cover securely, and check for refrigerant leaks. For the tightening torque, refer to the table below.

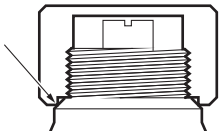

### To handle the service port

- Always use a charge hose equipped with a valve depressor pin, since the service port is a Schrader type valve.
- After handling the service port, make sure to tighten the service port cover securely. For the tightening torque, refer to the table below.
- Check for refrigerant leaks after tightening the service port cover.

### Tightening torques

Stop valve size (mm)	Tightening torque N·m (turn clockwise to close)			
	Shaft			
	Valve body	Hexagonal wrench	Cap (valve lid)	Service port
$\varnothing 9.5$	5.4~6.6	4 mm	13.5~16.5	11.5~13.9
$\varnothing 12.7$	8.1~9.9		18.0~22.0	
$\varnothing 19.1$	27.0~33.0	8 mm	22.5~27.5	

### 5.3.2 To remove the pinched pipes



#### WARNING

Any gas or oil remaining inside the stop valve may blow off the pinched piping.

Failure to observe the instructions in procedure below properly may result in property damage or personal injury, which may be serious depending on the circumstances.

Use the following procedure to remove the pinched piping:

- 1 Remove the valve cover and make sure that the stop valves are fully closed.

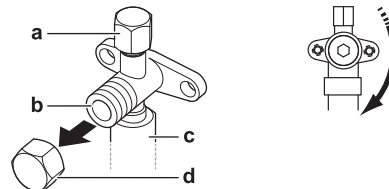

- a Service port and service port cover
- b Stop valve
- c Field piping connection
- d Stop valve cover

- 2 Connect the vacuuming/recovery unit through a manifold to the service port of all stop valves.

You have to recover gas and oil from all 4 pinched pipes. Depending on your available tools, use method 1 (manifold with refrigerant line splitters required) or method 2.

Manifold	Connections	Compressor unit
	<b>Method 1:</b> Connect to all service ports at once. 	<b>5 HP</b> 
	<b>Method 2:</b> First connect to the first 2 service ports.  Then connect to the last 2 service ports. 	<b>8 HP</b> 

- a, b, c, d Service ports of stop valves
- e Vacuuming/recovery unit
- A, B, C Valves A, B and C
- D Refrigerant line splitter

- 3 Recover gas and oil from the pinched piping by using a recovery unit.



#### CAUTION

Do not vent gases into the atmosphere.

- 4 When all gas and oil is recovered from the pinched piping, disconnect the charge hose and close the service ports
- 5 Cut off the lower part of the gas and liquid stop valve pipes along the black line. Use an appropriate tool (e.g. a pipe cutter, a pair of nippers).



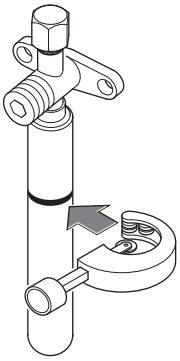

### WARNING



Never remove the pinched piping by brazing.

Any gas or oil remaining inside the stop valve may blow off the pinched piping.

- Wait until all oil is dripped out before continuing with the connection of the field piping in case the recovery was not complete.

### 5.3.3 To connect the refrigerant piping to the compressor unit



### NOTICE

- Be sure to use the supplied accessory pipes when carrying out piping work in the field.
- Be sure that the field installed piping does not touch other pipes, the bottom panel or side panel.

- Remove the service cover. See "5.1.1 To open the compressor unit" on page 11.
- Choose a piping route (a or b).

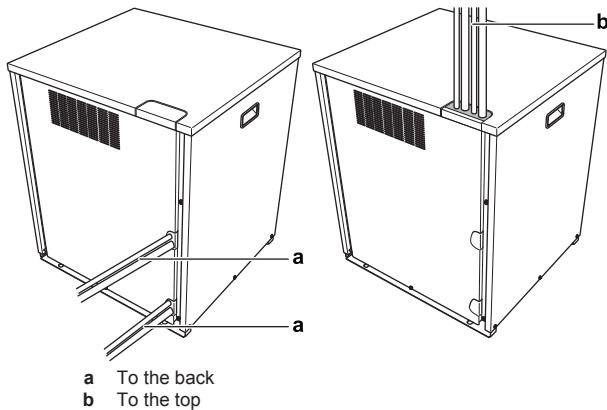

- If you have chosen the piping route to the top:

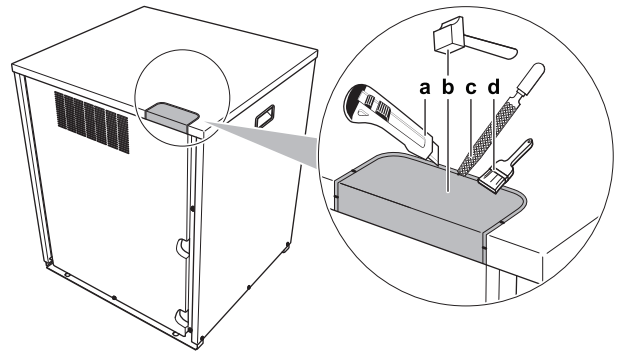

- Cut the insulation (under the knockout hole).
- Hit on the knockout hole, and remove it.
- Remove the burrs.
- Paint the edges and areas around the edges using repair paint to prevent rusting.



### NOTICE

Precautions when making knockout holes:

- Avoid damaging the casing.
- After making the knockout holes, we recommend you remove the burrs and paint the edges and areas around the edges using repair paint to prevent rusting.
- When passing electrical wiring through the knockout holes, wrap the wiring with protective tape to prevent damage.

- Connect piping (by brazing) as follows:

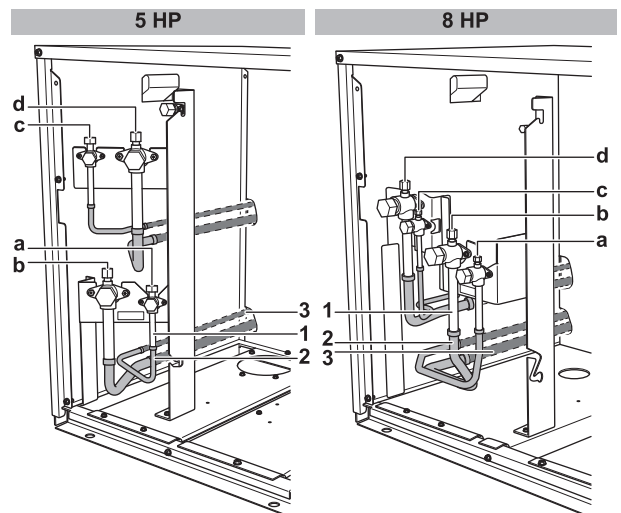

- Liquid line (circuit 1: to heat exchanger unit)
- Gas line (circuit 1: to heat exchanger unit)
- Liquid line (circuit 2: to indoor units)
- Gas line (circuit 2: to indoor units)
- Pinched piping
- Piping accessory
- Field piping

- Reattach the service cover.
- Seal all gaps (example: a) to prevent small animals from entering the system.

## 5 Installation

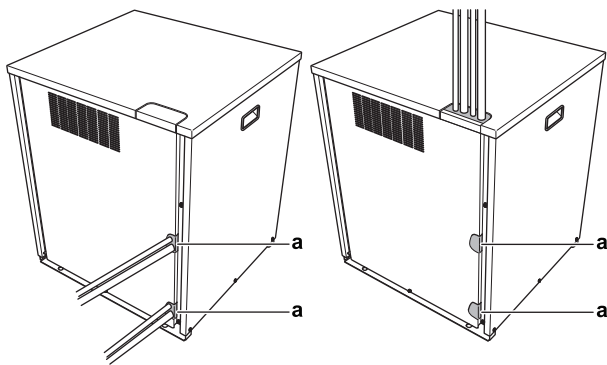

### WARNING

Provide adequate measures to prevent that the unit can be used as a shelter by small animals. Small animals that make contact with electrical parts can cause malfunctions, smoke or fire.

## 5.4 Checking the refrigerant piping

### 5.4.1 About checking the refrigerant piping

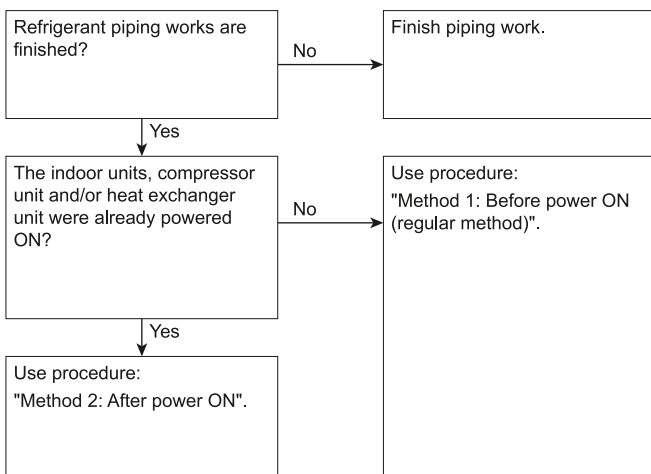

It is very important that all refrigerant piping work is done before the units (compressor unit, heat exchanger unit or indoor units) are powered on.

When the units are powered on, the expansion valves will initialise. This means that they will close. Leak test and vacuum drying of field piping, heat exchanger unit and indoor units is impossible when this happens.

Therefore, there will be explained 2 methods for initial installation, leak test and vacuum drying.

#### Method 1: Before power ON

If the system has not yet been powered on, no special action is required to perform the leak test and the vacuum drying.

#### Method 2: After power ON

If the system has already been powered on, activate setting [2-21] (refer to "6.1.4 To access mode 1 or 2" on page 21). This setting will open field expansion valves to guarantee a R410A piping pathway and make it possible to perform the leak test and the vacuum drying.



### NOTICE

Make sure that the heat exchanger unit and all indoor units connected to the compressor unit are powered on.



### NOTICE

Wait until the compressor unit has finished the initialisation to apply setting [2-21].

### Leak test and vacuum drying

Checking the refrigerant piping involves:

- Checking for any leakages in the refrigerant piping.
- Performing vacuum drying to remove all moisture, air or nitrogen in the refrigerant piping.

If there is a possibility of moisture being present in the refrigerant piping (for example, water may have entered the piping), first carry out the vacuum drying procedure below until all moisture has been removed.

All piping inside the unit has been factory tested for leaks.

Only field installed refrigerant piping needs to be checked. Therefore, make sure that all the compressor unit stop valves are firmly closed before performing leak test or vacuum drying.



### NOTICE

Make sure that all (field supplied) field piping valves are OPEN (not compressor unit stop valves!) before you start leak test and vacuuming.

For more information on the state of the valves, refer to "5.4.3 Checking refrigerant piping: Setup" on page 14.

### 5.4.2 Checking refrigerant piping: General guidelines

Connect the vacuum pump through a manifold to the service port of all stop valves to increase efficiency (refer to "5.4.3 Checking refrigerant piping: Setup" on page 14).



### NOTICE

Use a 2-stage vacuum pump with a non-return valve or a solenoid valve that can evacuate to a gauge pressure of  $-100.7 \text{ kPa}$  ( $-1.007 \text{ bar}$ )(5 Torr absolute).



### NOTICE

Make sure the pump oil does not flow oppositely into the system while the pump is not working.



### NOTICE

Do not purge the air with refrigerants. Use a vacuum pump to evacuate the installation.

### 5.4.3 Checking refrigerant piping: Setup

The system contains 2 refrigerant circuits:

- **Circuit 1:** Compressor unit → Heat exchanger unit
- **Circuit 2:** Compressor unit → Indoor units

You have to check both circuits (leak test, vacuuming drying). How to check depends on your available tools:

If you have a manifold...	Then
With refrigerant line splitters	You can check both circuits at once. To do so, connect the manifold via the splitters to both circuits, and check.
Without refrigerant line splitters (takes twice as long)	You have to check the circuits separately. To do so: <ul style="list-style-type: none"> <li>▪ First connect the manifold to <b>circuit 1</b>, and check.</li> <li>▪ Then connect the manifold to <b>circuit 2</b>, and check.</li> </ul>

Possible connections:

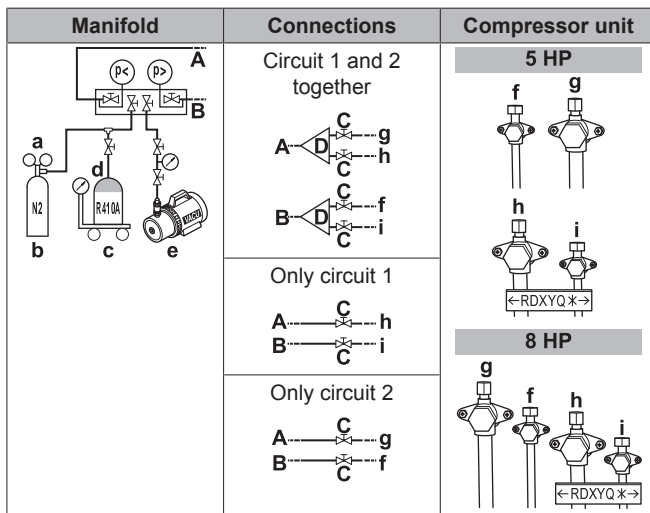

- a Pressure reducing valve
- b Nitrogen
- c Weighing scales
- d Refrigerant R410A tank (siphon system)
- e Vacuum pump
- f Liquid line stop valve (circuit 2: to indoor units)
- g Gas line stop valve (circuit 2: to indoor units)
- h Gas line stop valve (circuit 1: to heat exchanger unit)
- i Liquid line stop valve (circuit 1: to heat exchanger unit)
- A, B, C Valves A, B and C
- D Refrigerant line splitter

Valve	State of valve
Valves A, B and C	Open
Liquid line and gas line stop valves (f, g, h, i)	Close



### NOTICE

The connections to the indoor units and to the heat exchanger unit, and all indoor units and the heat exchanger unit itself should also be leak and vacuum tested. Keep any possible (field supplied) field piping valves open as well.

Refer to the indoor unit installation manual for more details. Leak test and vacuum drying should be done before the power supply is set to the unit. If not, see also the flow chart earlier described in this chapter (see "5.4.1 About checking the refrigerant piping" on page 14).

### 5.4.4 To perform a leak test

The leak test must satisfy the specifications of EN378-2.

#### To check for leaks: Vacuum leak test

- 1 Evacuate the system from the liquid and gas piping to  $-100.7 \text{ kPa}$  ( $-1.007 \text{ bar}$ ) (5 Torr absolute) for more than 2 hours.
- 2 Once reached, turn off the vacuum pump and check that the pressure does not rise for at least 1 minute.
- 3 Should the pressure rise, the system may either contain moisture (see vacuum drying below) or have leaks.

#### To check for leaks: Pressure leak test

- 1 Break the vacuum by pressurising with nitrogen gas to a minimum gauge pressure of  $0.2 \text{ MPa}$  (2 bar). Never set the gauge pressure higher than the maximum operation pressure of the unit, i.e.  $4.0 \text{ MPa}$  (40 bar).
- 2 Test for leaks by applying a bubble test solution to all piping connections.
- 3 Discharge all nitrogen gas.



### NOTICE

Make sure to use a recommended bubble test solution from your wholesaler. Do not use soap water, which may cause cracking of flare nuts (soap water may contain salt, which absorbs moisture that will freeze when the piping gets cold), and/or lead to corrosion of flared joints (soap water may contain ammonia which causes a corrosive effect between the brass flare nut and the copper flare).

### 5.4.5 To perform vacuum drying

To remove all moisture from the system, proceed as follows:

- 1 Evacuate the system for at least 2 hours to a target vacuum of  $-100.7 \text{ kPa}$  ( $-1.007 \text{ bar}$ ) (5 Torr absolute).
- 2 Check that, with the vacuum pump turned off, the target vacuum is maintained for at least 1 hour.
- 3 Should you fail to reach the target vacuum within 2 hours or maintain the vacuum for 1 hour, the system may contain too much moisture. In that case, break the vacuum by pressurising with nitrogen gas to a gauge pressure of  $0.05 \text{ MPa}$  (0.5 bar) and repeat steps 1 to 3 until all moisture has been removed.
- 4 Depending on whether you want to immediately charge refrigerant through the refrigerant charge port or first pre-charge a portion of refrigerant through the liquid line, either open the compressor unit stop valves, or keep them closed. See "5.6.3 To charge refrigerant" on page 16 for more information.

### 5.5 To insulate the refrigerant piping

After finishing the leak test and vacuum drying, the piping must be insulated. Take into account the following points:

- Make sure to insulate the connection piping and refrigerant branch kits entirely.
- Be sure to insulate the liquid and gas piping (for all units).
- Use heat resistant polyethylene foam which can withstand a temperature of  $70^\circ\text{C}$  for liquid piping and polyethylene foam which can withstand a temperature of  $120^\circ\text{C}$  for gas piping.
- Reinforce the insulation on the refrigerant piping according to the installation environment.

Ambient temperature	Humidity	Minimum thickness
$\leq 30^\circ\text{C}$	75% to 80% RH	15 mm
$> 30^\circ\text{C}$	$\geq 80\%$ RH	20 mm

Condensation might form on the surface of the insulation.

- If there is a possibility that condensation on the stop valve might drip down into the indoor unit or into the heat exchanger unit through gaps in the insulation and piping because the compressor unit is located higher than the indoor unit or higher than the heat exchanger unit, this must be prevented by sealing up the connections. See below figure.

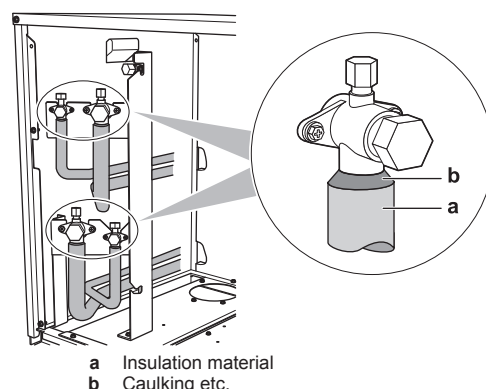

## 5 Installation

### 5.6 Charging refrigerant

#### 5.6.1 Precautions when charging refrigerant



#### WARNING

- Only use R410A as refrigerant. Other substances may cause explosions and accidents.
- R410A contains fluorinated greenhouse gases. Its global warming potential (GWP) value is 2087.5. Do NOT vent these gases into the atmosphere.
- When charging refrigerant, always use protective gloves and safety glasses.



#### NOTICE

If the power of some units is turned off, the charging procedure cannot be finished properly.



#### NOTICE

Be sure to turn on the power 6 hours before operation in order to have power running to the crankcase heater and to protect the compressor.



#### NOTICE

If operation is performed within 12 minutes after the compressor unit, heat exchanger unit and indoor units are turned on, the compressor will not operate before the communication is established in a correct way between the compressor unit, heat exchanger unit and indoor units.



#### NOTICE

Before starting charging procedures:

- In case of 5 HP: Check if the 7-LEDs display is as normal (see "6.1.4 To access mode 1 or 2" on page 21), and there is no malfunction code on the user interface of the indoor unit. If a malfunction code is present, see "8.1 Solving problems based on error codes" on page 29.
- In case of 8 HP: Check if the 7-segment display indication of the compressor unit A1P PCB is as normal (see "6.1.4 To access mode 1 or 2" on page 21). If a malfunction code is present, see "8.1 Solving problems based on error codes" on page 29.



#### NOTICE

Make sure all connected units (heat exchanger unit + indoor units) are recognised (setting [1-5]).

#### 5.6.2 To determine the additional refrigerant amount

##### Formula:

$$R = [(X_1 \times \varnothing 12.7) \times 0.12 + (X_2 \times \varnothing 9.5) \times 0.059 + (X_3 \times \varnothing 6.4) \times 0.022] \times A + B$$

R Additional refrigerant to be charged [in kg and rounded off to 1 decimal place]

$X_{1...3}$  Total length [m] of liquid piping size at  $\varnothing a$

A+B Parameters A and B

##### Parameters A and B:

Model	A	B
RKXYQ5	0.8 kg	3.1 kg
RKXYQ8	1.0 kg	2.6 kg

**Metric piping.** When using metric piping, replace the weight factors in the formula by the ones from the following table:

Inch piping		Metric piping	
Piping	Weight factor	Piping	Weight factor
Ø6.4 mm	0.022	Ø6 mm	0.018
Ø9.5 mm	0.059	Ø10 mm	0.065
Ø12.7 mm	0.12	Ø12 mm	0.097

#### 5.6.3 To charge refrigerant

Charging refrigerant consists of 2 stages:

Stage	Description
Stage 1: Pre-charging	Recommended in case of larger systems. Can be skipped, but charging will take longer then.
Stage 2: Manual charging	Only necessary if the determined additional refrigerant amount is <b>not reached</b> yet by pre-charging.

##### Stage 1: Pre-charging

Summary – Pre-charging:	
<b>Refrigerant bottle</b>	Connected to the service ports of the stop valves. Which stop valves to use depends on the circuits you choose to pre-charge to: <ul style="list-style-type: none"> <li>Circuits 1 and 2 together (manifold with refrigerant line splitters required).</li> <li>First circuit 1, then circuit 2 (or vice versa).</li> <li>Only circuit 1</li> <li>Only circuit 2</li> </ul>
<b>Stop valves</b>	Closed
<b>Compressor</b>	Does NOT operate

- Connect as shown (choose one of the possible connections). Make sure that all compressor unit stop valves, as well as valve A are closed.

Possible connections:

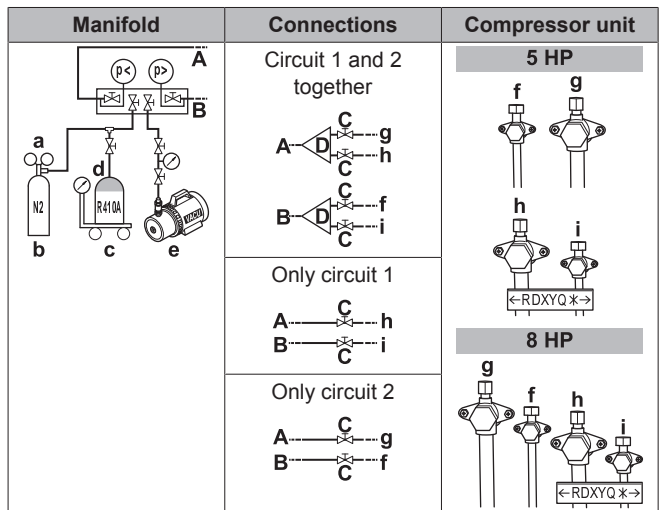

- a Pressure reducing valve
- b Nitrogen
- c Weighing scales
- d Refrigerant R410A tank (siphon system)
- e Vacuum pump
- f Liquid line stop valve (circuit 2: to indoor units)
- g Gas line stop valve (circuit 2: to indoor units)
- h Gas line stop valve (circuit 1: to heat exchanger unit)
- i Liquid line stop valve (circuit 1: to heat exchanger unit)
- A, B, C Valves A, B and C
- D Refrigerant line splitter

- Open valves C (on line of B) and B.



- Pre-charge refrigerant until the determined additional refrigerant amount is reached or pre-charging is not possible anymore, and then close valves C and B.
- Do one of the following:

If	Then
The determined additional refrigerant amount is <b>reached</b>	Disconnect the manifold from the liquid line(s). You do not have to perform the "Stage 2" instructions.
<b>Too much</b> refrigerant is charged	Recover refrigerant until the determined additional refrigerant is reached. Disconnect the manifold from the liquid line(s). You do not have to perform the "Stage 2" instructions.
The determined additional refrigerant amount is <b>not reached</b> yet	Disconnect the manifold from the liquid line(s). Continue with the "Stage 2" instructions.

### Stage 2: Manual charging

(= charging in the "Manual additional refrigerant charge" mode)

Summary – Manual charging:	
<b>Refrigerant bottle</b>	Connected to the service port for refrigerant charge. This charges to both circuits, and to the compressor unit's internal refrigerant piping.
<b>Stop valves</b>	Open
<b>Compressor</b>	Operates

- Connect as shown. Make sure valve A is closed.

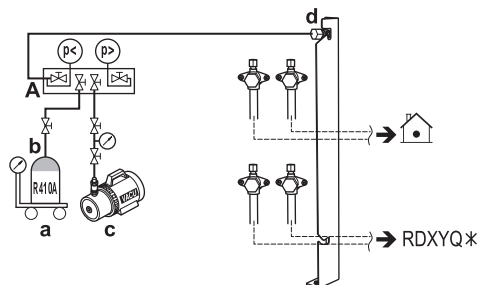

- a Weighing scales
- b Refrigerant R410A tank (siphon system)
- c Vacuum pump
- d Refrigerant charge port
- A Valve A



#### NOTICE

The refrigerant charging port is connected to the piping inside the unit. The unit's internal piping is already factory charged with refrigerant, so be careful when connecting the charge hose.

- Open all compressor unit stop valves. At this point, valve A must remain closed!
- Take all the precautions mentioned in "6 Configuration" on page 19 and "7 Commissioning" on page 27 into account.
- Turn on the power of the indoor units, compressor unit and heat exchanger unit.
- Activate setting [2-20] to start the manual additional refrigerant charge mode. For details, see "6.1.8 Mode 2: Field settings" on page 24.

**Result:** The unit will start operation.



#### INFORMATION

The manual refrigerant charge operation will automatically stop within 30 minutes. If charging is not completed after 30 minutes, perform the additional refrigerant charging operation again.



#### INFORMATION

- When a malfunction is detected during the procedure (e.g., in case of closed stop valve), a malfunction code will be displayed. In that case, refer to "5.6.4 Error codes when charging refrigerant" on page 17 and solve the malfunction accordingly. Resetting the malfunction can be done by pushing BS3. You can restart the "Charging" instructions.
- Aborting the manual refrigerant charge is possible by pushing BS3. The unit will stop and return to idle condition.

- Open valve A.
- Charge refrigerant until the remaining determined additional refrigerant amount is added, and then close valve A.
- Press BS3 to stop the manual additional refrigerant charge mode.



#### NOTICE

Make sure to open all stop valves after (pre-) charging the refrigerant.

Operating with the stop valves closed will damage the compressor.



#### NOTICE

After adding the refrigerant, do not forget to close the lid of the refrigerant charging port. The tightening torque for the lid is 11.5 to 13.9 N·m.

### 5.6.4 Error codes when charging refrigerant



#### INFORMATION

If a malfunction occurs:

- In case of 5 HP: The error code is displayed on the user interface of the indoor unit.
- In case of 8 HP: The error code is displayed on the compressor unit's 7-segments display and on the user interface of the indoor unit.

If a malfunction occurs, close valve A immediately. Confirm the malfunction code and take corresponding action, "8.1 Solving problems based on error codes" on page 29.

### 5.6.5 To fix the fluorinated greenhouse gases label

- Fill in the label as follows:

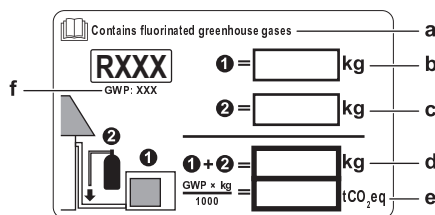

- If a multilingual fluorinated greenhouse gases label is delivered with the unit (see accessories), peel off the applicable language and stick it on top of a.
- Factory refrigerant charge: see unit name plate
- Additional refrigerant amount charged
- Total refrigerant charge
- Greenhouse gas emissions** of the total refrigerant charge expressed as tonnes CO<sub>2</sub>-equivalent

## 5 Installation

f GWP = Global warming potential

### NOTICE

In Europe, the **greenhouse gas emissions** of the total refrigerant charge in the system (expressed as tonnes CO<sub>2</sub>-equivalent) is used to determine the maintenance intervals. Follow the applicable legislation.

**Formula to calculate the greenhouse gas emissions:**  
GWP value of the refrigerant × Total refrigerant charge [in kg] / 1000

- Fix the label on the inside of the compressor unit. There is a dedicated place for it on the wiring diagram label.

## 5.7 Connecting the electrical wiring

### 5.7.1 Field wiring: Overview

Field wiring consists of:

- Power supply (always including earth)
- Communication (= transmission) wiring between the compressor unit, the heat exchanger unit, and the indoor units.

#### Example:

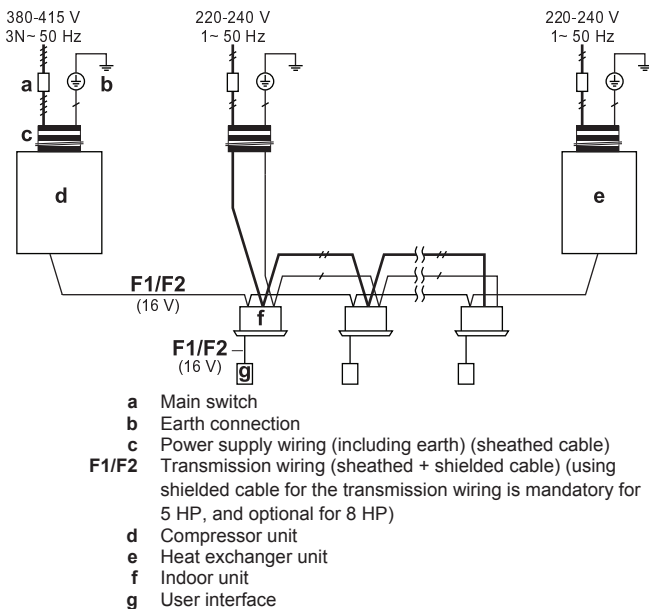

#### Branches

No branching is allowed after branching.

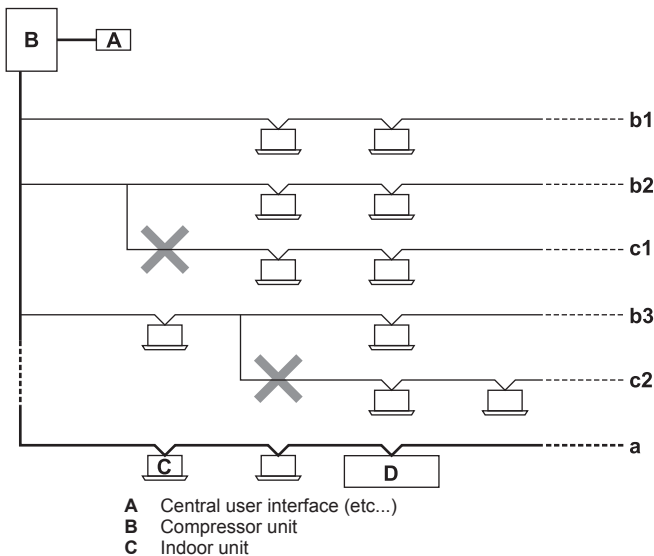

- D Heat exchanger unit  
a Main line. The main line is the line to which the transmission wiring of the heat exchanger unit is connected.  
b1, b2, b3 Branch lines  
c1, c2 No branch is allowed after branch

### 5.7.2 Guidelines when connecting the electrical wiring

#### Tightening torques

Wiring	Screw size	Tightening torque (N·m)
Power supply wiring (power supply + shielded ground)	M5	2.0~3.0
Transmission wiring	M3.5	0.8~0.97

### 5.7.3 To connect the electrical wiring on the compressor unit

#### NOTICE

- Follow the wiring diagram (delivered with the unit, located on the switch box cover).
- Make sure the electrical wiring does NOT obstruct proper reattachment of the service cover.

- Remove the service covers of the compressor unit and the switch box.
- Connect the transmission wiring as follows:

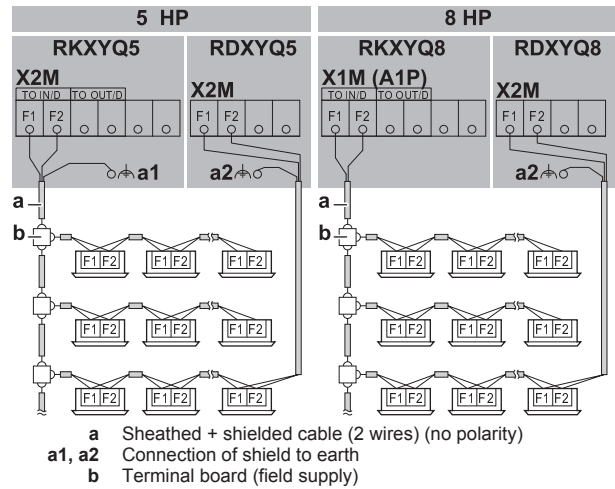

#### WARNING

**Shielded cable.** Using shielded cable for the transmission wiring is mandatory for 5 HP, and optional for 8 HP.

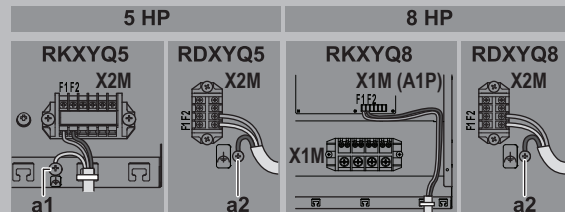

a1, a2 Earth (use the screw delivered as accessory)

When using shielded cable:

- In case of 5 HP (a1 and a2): Connect the shield to the earth of the compressor unit and the heat exchanger unit.
- In case of 8 HP (only a2): Connect the shield only to the earth of the heat exchanger unit.

3 Connect the power supply as follows:

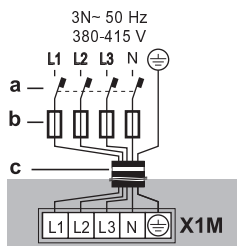

- a Earth leakage circuit breaker
- b Fuse
- c Power supply cable

4 Route the wiring through the frame, and fix the cables (power supply and transmission wiring) with cable ties.

### INFORMATION

To make routing the wiring easier, you can turn the switch box horizontally by loosening the screw on the left side of the switch box.

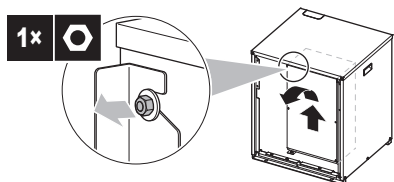

6 Connect an earth leakage circuit breaker and fuse to the power supply line.

## 5.8 Finishing the compressor unit installation

### 5.8.1 To finish the transmission wiring

After installing the transmission wires inside the unit, wrap them along with the on-site refrigerant pipes using finishing tape, as shown in figure below.

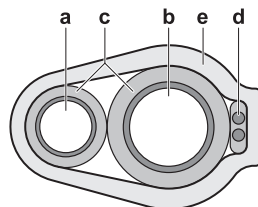

- a Liquid pipe
- b Gas pipe
- c Insulator
- d Transmission wiring (F1/F2)
- e Finishing tape

## 6 Configuration

### INFORMATION

It is important that all information in this chapter is read sequentially by the installer and that the system is configured as applicable.

### DANGER: RISK OF ELECTROCUTION

## 6.1 Making field settings

### 6.1.1 About making field settings

To configure the heat pump system, you must give input to the compressor unit's main PCB (A1P). This involves the following field setting components:

- Push buttons to give input to the PCB
- A display to read feedback from the PCB
- DIP switches (only change the factory settings if you install a cool/heat selector switch).

Field settings are defined by their mode, setting and value. Example: [2-8]=4.

#### PC configurator

You can also make field settings through a personal computer interface (for this, option EKPCCAB is required). The installer can prepare the configuration (off-site) on PC and afterwards upload the configuration to the system.

See also: "6.1.9 To connect the PC configurator to the compressor unit" on page 27.

#### Mode 1 and 2

Mode	Description
Mode 1 (monitoring settings)	Mode 1 can be used to monitor the current situation of the compressor unit. Some field setting contents can be monitored as well.

### 5 HP

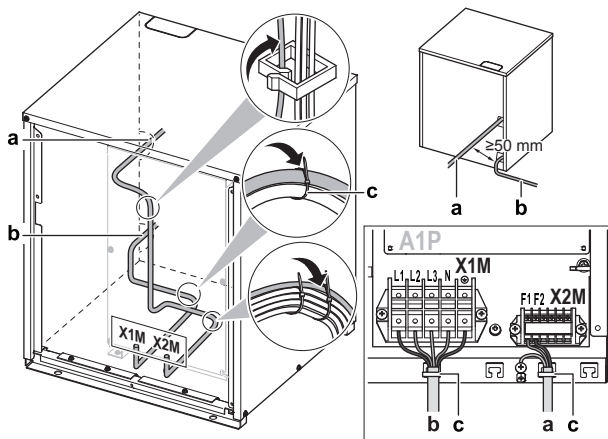

### 8 HP

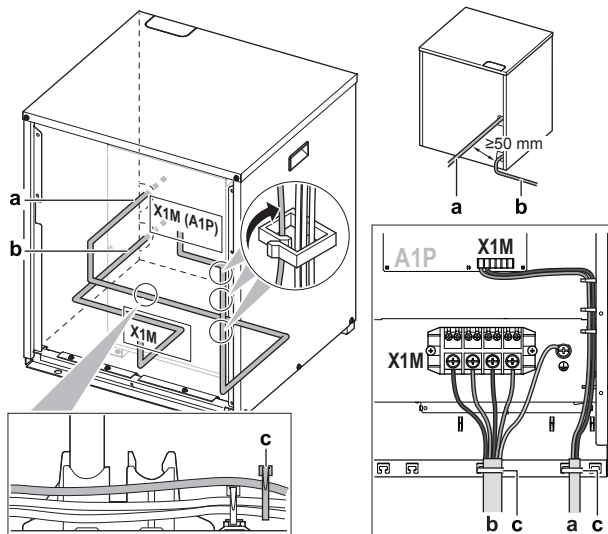

- a Transmission wiring
- b Power supply
- c Cable tie

5 Reattach the service covers.

## 6 Configuration

Mode	Description
Mode 2 (field settings)	<p>Mode 2 is used to change the field settings of the system. Consulting the current field setting value and changing the current field setting value is possible.</p> <p>In general, normal operation can be resumed without special intervention after changing field settings.</p> <p>Some field settings are used for special operation (e.g., 1 time operation, recovery/vacuuuming setting, manual adding refrigerant setting, etc.). In such a case, it is required to abort the special operation before normal operation can restart. It will be indicated in below explanations.</p>

### 6.1.2 To access the field setting components

See "5.1.1 To open the compressor unit" on page 11.

### 6.1.3 Field setting components

The components to make field settings differ depending on the model.

Model	Field setting components
5 HP	<ul style="list-style-type: none"> <li>Push buttons (BS1~BS5)</li> <li>7-LEDs display (H1P~H7P)</li> <li>H8P: LED for indication during initialisation</li> <li>DIP switches (DS1)</li> </ul>
8 HP	<ul style="list-style-type: none"> <li>Push buttons (BS1~BS3)</li> <li>7-segments display (888)</li> <li>DIP switches (DS1 and DS2)</li> </ul>

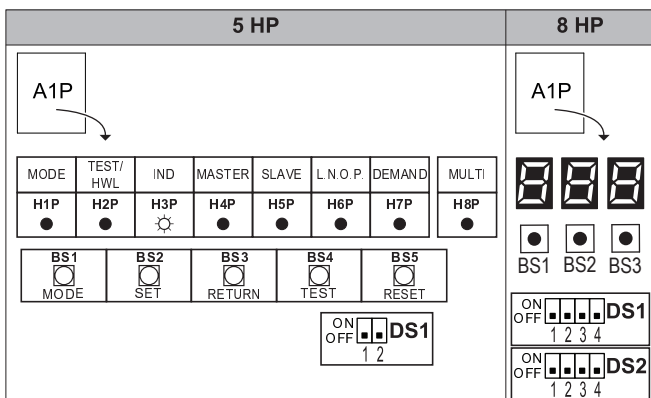

ON (☀) OFF (●) Flashing (⚡)

ON (☑) OFF (☐) Flashing (⚡)

#### DIP switches

Only change the factory settings if you install a cool/heat selector switch.

Model	DIP switch
5 HP	<ul style="list-style-type: none"> <li>DS1-1: COOL/HEAT selector (refer to the manual of the cool/heat selector switch). OFF=not installed=factory setting</li> <li>DS1-2: NOT USED. DO NOT CHANGE THE FACTORY SETTING.</li> </ul>

Model	DIP switch
8 HP	<ul style="list-style-type: none"> <li>DS1-1: COOL/HEAT selector (see "3.3.1 Possible options for the compressor unit and heat exchanger unit" on page 7). OFF=not installed=factory setting</li> <li>DS1-2~4: NOT USED. DO NOT CHANGE THE FACTORY SETTING.</li> <li>DS2-1~4: NOT USED. DO NOT CHANGE THE FACTORY SETTING.</li> </ul>

#### Push buttons

Use the push buttons to make the field settings. Operate the push buttons with an insulated stick (such as a closed ball-point pen) to avoid touching of live parts.



The push buttons differ depending on the model.

Model	Push buttons
5 HP	<ul style="list-style-type: none"> <li>BS1: MODE: For changing the set mode</li> <li>BS2: SET: For field setting</li> <li>BS3: RETURN: For field setting</li> <li>BS4: TEST: For test operation</li> <li>BS5: RESET: For resetting the address when the wiring is changed or when an additional indoor unit is installed</li> </ul>
8 HP	<ul style="list-style-type: none"> <li>BS1: MODE: For changing the set mode</li> <li>BS2: SET: For field setting</li> <li>BS3: RETURN: For field setting</li> </ul>

#### 7-LEDs display or 7-segments display

The display gives feedback about the field settings, which are defined as [Mode-Setting]=Value.

The display differs depending on the model.

Model	Display
5 HP	<p>7-LEDs display:</p> <ul style="list-style-type: none"> <li>H1P: Shows the mode</li> <li>H2P~H7P: Shows the settings and values, represented in binary code</li> </ul> <p>(H8P: NOT used for field settings, but used during initialisation)</p>
8 HP	7-segments display (888)

#### Example:

[H1P- 32 + 16 + 8 + 4 + 2 + 1] H1P H2P H3P H4P H5P H6P H7P	Display	Description
● ● ● ● ● ● ●	888	Default situation
☀ ● ● ● ● ● ● ●	888	Mode 1
☀ ● ● ● ● ● ● ●	888	Mode 2
☀ ● ● ● ● ● ● ● 0 + 0 + 8 + 0 + 0 + 0	888	Setting 8 (in mode 2)



[H1P- 32 + 16 + 8 + 4 + 2 + 1] H1P H2P H3P H4P H5P H6P H7P		<b>Description</b>
 0 + 0 + 0 + 4 + 0 + 0 (H2P~H7P = binary 4)		Value 4 (in mode 2)

## 6.1.4 To access mode 1 or 2

After the units are turned ON, the display goes to its default situation. From there, you can access mode 1 and mode 2.

### Initialisation: default situation



#### NOTICE

Be sure to turn on the power 6 hours before operation in order to have power running to the crankcase heater and to protect the compressor.

Turn on the power supply of the compressor unit, heat exchanger unit, and all indoor units. When the communication between the compressor unit, heat exchanger unit, and indoor units is established and normal, the display indication state will be as below (default situation when shipped from factory).

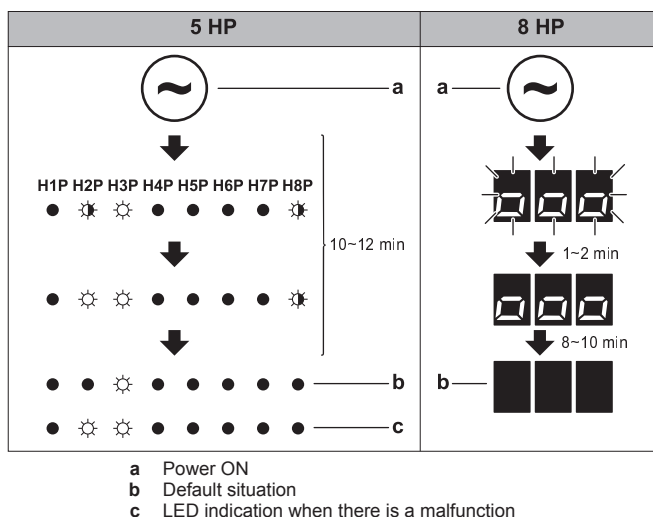

If the default situation is not displayed after 10~12 minutes, check the malfunction code on the indoor unit user interface (and in case of 8 HP on the compressor unit 7-segment display). Solve the malfunction code accordingly. First, check the communication wiring.

### Switching between modes

Use BS1 to switch between the default situation, mode 1 and mode 2.

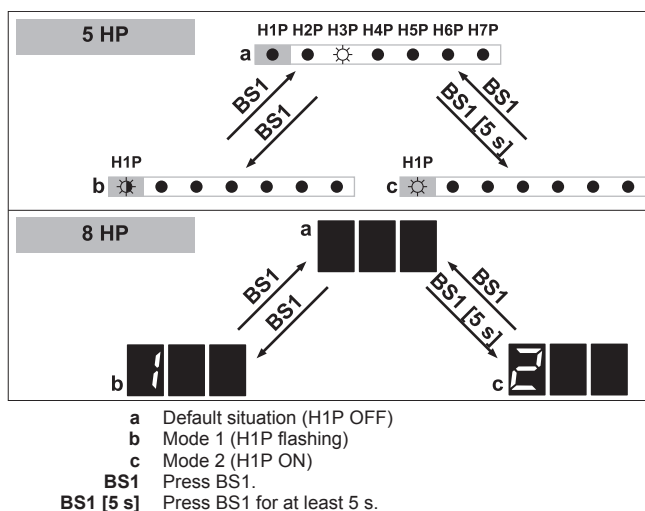

#### INFORMATION

If you get confused in the middle of the process, press BS1 to return to the default situation.

## 6.1.5 To use mode 1 (and default situation)

In mode 1 (and in default situation) you can read out some information. How to do this differs depending on the model.

### Example: 7-LEDs display – Default situation

(in case of 5 HP)

You can read out the status of low noise operation as follows:

#	Action	Button/display
1	Make sure the LEDs are showing the default situation.	H1P H2P H3P H4P H5P H6P H7P  (H1P OFF)
2	Check the status of LED H6P.	 H6P OFF: Unit is currently not operating under low noise restrictions.  H6P ON: Unit is currently operating under low noise restrictions.

### Example: 7-LEDs display – Mode 1

(in case of 5 HP)

You can read out setting [1-5] (= the total number of connected units (heat exchanger unit + indoor units)) as follows:

#	Action	Button/display
1	Start from the default situation.	H1P H2P H3P H4P H5P H6P H7P 
2	Select mode 1.	BS1 [1×] 
3	Select setting 5. ("X" depends on the setting that you want to select.)	BS2 [X×]  (= binary 5)
4	Display the value of setting 5. (there are 8 units connected)	BS3 [1×]  (= binary 8)
5	Quit mode 1.	BS1 [1×] 

### Example: 7-segments display – Mode 1

(in case of 8 HP)

You can read out setting [1-10] (= the total number of connected units (heat exchanger unit + indoor units)) as follows:

#	Action	Button/display
1	Start from the default situation.	
2	Select mode 1.	BS1 [1×] 
3	Select setting 10. ("X" depends on the setting that you want to select.)	BS2 [X×] 

## 6 Configuration

#	Action	Button/display
4	Display the value of setting 10. (there are 8 units connected)	↓BS3 [1×] 
5	Quit mode 1.	↓BS1 [1×] 

### 6.1.6 To use mode 2

In mode 2 you can make field settings to configure the system. How to do this differs slightly depending on the model.

#### Example: 7-LEDs display – Mode 2

(in case of 5 HP)

You can change the value of setting [2-8] (=  $T_e$  target temperature during cooling operation) to 4 (= 8°C) as follows:

#	Action	Button/display
1	Start from the default situation.	H1P H2P H3P H4P H5P H6P H7P 
2	Select mode 2.	↓BS1 [5 s] 
3	Select setting 8. ("X×" depends on the setting that you want to select.)	↓BS2 [X×]  (= binary 8)
4	Select value 4 (= 8°C). a: Display the current value. b: Change to 4. ("X×" depends on the current value, and the value that you want to select.) c: Enter the value in the system. d: Confirm. The system starts operating according to the setting.	a ↓BS3 [1×]  b ↓BS2 [X×]  c ↓BS3 [1×]  d ↓BS3 [1×] 
5	Quit mode 2.	↓BS1 [1×] 

#### Example: 7-segments display – Mode 2

(in case of 8 HP)

You can change the value of setting [2-8] (=  $T_e$  target temperature during cooling operation) to 4 (= 8°C) as follows:

#	Action	Button/display
1	Start from the default situation.	
2	Select mode 2.	↓BS1 [5 s] 
3	Select setting 8. ("X×" depends on the setting that you want to select.)	↓BS2 [X×] 

#	Action	Button/display
4	Select value 4 (= 8°C). a: Display the current value. b: Change to 4. ("X×" depends on the current value, and the value that you want to select.) c: Enter the value in the system. d: Confirm. The system starts operating according to the setting.	a ↓BS3 [1×]  b ↓BS2 [X×] c ↓BS3 [1×] d ↓BS3 [1×] 
5	Quit mode 2.	↓BS1 [1×] 

### 6.1.7 Mode 1 (and default situation): Monitoring settings



In mode 1 (and in default situation) you can read out some information. What you can read out differs depending on the model.

#### 7-LEDs display – Default situation (H1P OFF)

(in case of 5 HP)

You can read out the following information:





	Value / Description					
H6P	Shows the status of low noise operation.					
	<table border="1"> <tr> <td>OFF</td> <td></td> <td>Unit is currently not operating under low noise restrictions.</td> </tr> <tr> <td>ON</td> <td></td> <td>Unit is currently operating under low noise restrictions.</td> </tr> </table>	OFF		Unit is currently not operating under low noise restrictions.	ON	
OFF		Unit is currently not operating under low noise restrictions.				
ON		Unit is currently operating under low noise restrictions.				
<p>Low noise operation reduces the sound generated by the unit compared to nominal operating conditions.</p> <p>Low noise operation can be set in mode 2. There are two methods to activate low noise operation of the compressor unit and heat exchanger unit.</p> <ul style="list-style-type: none"> <li>The first method is to enable an automatic low noise operation during night time by field setting. The unit will operate at the selected low noise level during the selected time frames.</li> <li>The second method is to enable low noise operation based on an external input. For this operation an optional accessory is required.</li> </ul>						

Value / Description	
H7P	Shows the status of power consumption limitation operation.
OFF	 Unit is currently not operating under power consumption limitations.
ON	 Unit is currently operating under power consumption limitation.
<p>Power consumption limitation reduces the power consumption of the unit compared to nominal operating conditions.</p> <p>Power consumption limitation can be set in mode 2. There are two methods to activate power consumption limitation of the compressor unit.</p> <ul style="list-style-type: none"> <li>The first method is to enable a forced power consumption limitation by field setting. The unit will always operate at the selected power consumption limitation.</li> <li>The second method is to enable power consumption limitation based on an external input. For this operation an optional accessory is required.</li> </ul>	

### 7-LEDs display – Mode 1 (H1P flashing)

(in case of 5 HP)

You can read out the following information:

Setting (H1P H2P H3P H4P H5P H6P H7P)	Value / Description
[1-5] 	It can be convenient to check if the total number of units which are installed (heat exchanger unit + indoor units) match the total number of units which are recognised by the system. In case there is a mismatch, it is advised to check the communication wiring path between compressor unit and heat exchanger unit, and between compressor unit and indoor units (F1/F2 communication line).
[1-14] 	When the latest malfunction codes were reset by accident on an indoor unit user interface, they can be checked again through this monitoring settings.
[1-15] 	Shows the 2nd last malfunction code. For the content or reason behind the malfunction code see "8.1 Solving problems based on error codes" on page 29, where most relevant malfunction codes are explained. Detailed information about malfunction codes can be consulted in the service manual of this unit.
[1-16] 	To obtain more detailed information about the malfunction code, press BS2 up to 3 times.

### 7-segments display – Mode 1

(in case of 8 HP)

You can read out the following information:

Setting	Value / Description	
[1-1]	0	Unit is currently not operating under low noise restrictions.
Shows the status of low noise operation.	1	Unit is currently operating under low noise restrictions.
	<p>Low noise operation reduces the sound generated by the unit compared to nominal operating conditions.</p> <p>Low noise operation can be set in mode 2. There are two methods to activate low noise operation of the compressor unit and heat exchanger unit.</p> <ul style="list-style-type: none"> <li>The first method is to enable an automatic low noise operation during night time by field setting. The unit will operate at the selected low noise level during the selected time frames.</li> <li>The second method is to enable low noise operation based on an external input. For this operation an optional accessory is required.</li> </ul>	
[1-2]	0	Unit is currently not operating under power consumption limitations.
Shows the status of power consumption limitation operation.	1	Unit is currently operating under power consumption limitation.
	<p>Power consumption limitation reduces the power consumption of the unit compared to nominal operating conditions.</p> <p>Power consumption limitation can be set in mode 2. There are two methods to activate power consumption limitation of the compressor unit.</p> <ul style="list-style-type: none"> <li>The first method is to enable a forced power consumption limitation by field setting. The unit will always operate at the selected power consumption limitation.</li> <li>The second method is to enable power consumption limitation based on an external input. For this operation an optional accessory is required.</li> </ul>	
[1-5]	For more information, see setting [2-8].	
[1-6]	For more information, see setting [2-9].	
[1-10]	It can be convenient to check if the total number of units which are installed (heat exchanger unit + indoor units) match the total number of units which are recognised by the system. In case there is a mismatch, it is advised to check the communication wiring path between compressor unit and heat exchanger unit, and between compressor unit and indoor units (F1/F2 communication line).	

## 6 Configuration















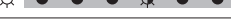





Setting	Value / Description
[1-17] Shows the latest malfunction code.	When the latest malfunction codes were reset by accident on an indoor unit user interface, they can be checked again through this monitoring settings.
[1-18] Shows the 2nd last malfunction code.	For the content or reason behind the malfunction code see "8.1 Solving problems based on error codes" on page 29, where most relevant malfunction codes are explained. Detailed information about malfunction codes can be consulted in the service manual of this unit.
[1-19] Shows the 3rd last malfunction code.	

Setting	Value / Description
[1-40] Shows the current cooling comfort setting.	For more information, see setting [2-81].
[1-41] Shows the current heating comfort setting.	For more information, see setting [2-82].







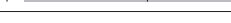















































### 6.1.8 Mode 2: Field settings

In mode 2 you can make field settings to configure the system. The display and the settings differ depending on the model.























Model	Display	Setting/value
5 HP	<b>H1P H2P H3P H4P H5P H6P H7P</b> 7-LEDs display	The seven LEDs give a binary representation of the setting/value number.
8 HP	<b>888</b> 7-segments display	The three 7-segments show the setting/value number.

Setting	Value		Description
	<b>888</b> (8 HP)	H1P H2P H3P H4P H5P H6P H7P (5 HP)	
[2-8]  T <sub>e</sub> target temperature during cooling operation.	0 (default)	 (default)	Auto
	2		6°C
	3		7°C
	4		8°C
	5		9°C
	6		10°C
	7		11°C
[2-9]  T <sub>e</sub> target temperature during heating operation.	0 (default)	 (default)	Auto
	1		41°C
	3		43°C
	6		46°C
[2-12]  Enable the low noise function and/or power consumption limitation via external control adaptor (DTA104A61/62).  If the system needs to be running under low noise operation or under power consumption limitation conditions when an external signal is sent to the unit, this setting should be changed. This setting will only be effective when the optional external control adaptor (DTA104A61/62) is installed in the indoor unit.	0 (default)	 (= binary 1) (default)	Deactivated.
	1	 (= binary 2)	Activated.
[2-15]  Fan static pressure setting (in heat exchanger unit).  You can set the external static pressure of the heat exchanger unit according to the ducting requirements.	0		30 Pa
	1 (default)	 (default)	60 Pa
	2		90 Pa
	3		120 Pa
	4		150 Pa



Setting	Value			
	 (8 HP)	H1P H2P H3P H4P H5P H6P H7P (5 HP)	Description	
[2-16]  ●  ● ● ● ● ● Test run heat exchanger unit. When activated, the heat exchanger fans start running. This allows you to check the ducting with a running heat exchanger unit.	0 (default)	—	Deactivated.	
	1	—	Activated.	
[2-20]  ●  ●  ● ● ● ● ● Manual additional refrigerant charge. In order to add the additional refrigerant charge amount in a manual way (without automatic refrigerant charging functionality), following setting should be applied.	0 (default)	 ● ● ● ● ●  (= binary 1) (default)	Deactivated.	
	1	 ● ● ● ● ●  ● ● (= binary 2)	Activated. To stop the manual additional refrigerant charge operation (when the required additional refrigerant amount is charged), push BS3. If this function was not aborted by pushing BS3, the unit will stop its operation after 30 minutes. If 30 minutes was not sufficient to add the needed refrigerant amount, the function can be reactivated by changing the field setting again.	
[2-21]  ●  ●  ● ● ● ● ● Refrigerant recovery/vacuumping mode. In order to achieve a free pathway to reclaim refrigerant out of the system or to remove residual substances or to vacuum the system it is necessary to apply a setting which will open required valves in the refrigerant circuit so the reclaim of refrigerant or vacuuming process can be done properly.	0 (default)	 ● ● ● ● ●  (= binary 1) (default)	Deactivated.	
	1	 ● ● ● ● ●  ● ● (= binary 2)	Activated. To stop the refrigerant recovery/vacuumping mode, push BS1 (in case of 5 HP) or BS3 (in case of 8 HP). If it is not pushed, the system will remain in refrigerant recovery/vacuumping mode.	
[2-22]  ●  ●  ●  ● ● ● ● ● Automatic low noise setting and level during night time. By changing this setting, you activate the automatic low noise operation function of the unit and define the level of operation. Depending on the chosen level, the noise level will be lowered. The start and stop moments for this function are defined under setting [2-26] and [2-27].	0 (default)	 ● ● ● ● ● ● ● ● ● ● (default)	Deactivated	
	1	 ● ● ● ● ●  ● ● ● ● ● ● ● ● ● ●	Level 1	Level 3<Level 2<Level 1
	2	 ● ● ● ● ●  ● ● ● ● ● ● ● ● ● ●	Level 2	
	3	 ● ● ● ● ●  ● ● ● ● ● ● ● ● ● ●	Level 3	
[2-25]  ●  ●  ● ● ● ● ● Low noise operation level via the external control adaptor. If the system needs to be running under low noise operation conditions when an external signal is sent to the unit, this setting defines the level of low noise that will be applied. This setting will only be effective when the optional external control adaptor (DTA104A61/62) is installed and the setting [2-12] was activated.	1	 ● ● ● ● ● ● ● ● ● ●	Level 1	Level 3<Level 2<Level 1
	2 (default)	 ● ● ● ● ●  ● ● ● ● ● ● ● ● ● ● (default)	Level 2	
	3	 ● ● ● ● ●  ● ● ● ● ● ● ● ● ● ● (= binary 4)	Level 3	
[2-26]  ●  ●  ●  ● ● ● ● ● Low noise operation start time. This setting is used in conjunction with setting [2-22].	1	 ● ● ● ● ● ● ● ● ● ●	20h00	
	2 (default)	 ● ● ● ● ●  ● ● ● ● ● ● ● ● ● ● (default)	22h00	
	3	 ● ● ● ● ●  ● ● ● ● ● ● ● ● ● ● (= binary 4)	24h00	
[2-27]  ●  ●  ●  ● ● ● ● ● Low noise operation stop time. This setting is used in conjunction with setting [2-22].	1	 ● ● ● ● ● ● ● ● ● ●	6h00	
	2	 ● ● ● ● ●  ● ● ● ● ● ● ● ● ● ●	7h00	
	3 (default)	 ● ● ● ● ●  ● ● ● ● ● ● ● ● ● ● (= binary 4) (default)	8h00	

## 6 Configuration

Setting	Value		
	 (8 HP)	H1P H2P H3P H4P H5P H6P H7P (5 HP)	Description
<p>[2-30] </p> <p>Power consumption limitation level (step 1) via the external control adaptor (DTA104A61/62).</p> <p>If the system needs to be running under power consumption limitation conditions when an external signal is sent to the unit, this setting defines the level power consumption limitation that will be applied for step 1. The level is according to the table.</p>	1		60%
	2	—	65%
	3 (default)	 (= binary 2) (default)	70%
	4	—	75%
	5	 (= binary 4)	80%
	6	—	85%
	7	—	90%
	8	—	95%
<p>[2-31] </p> <p>Power consumption limitation level (step 2) via the external control adaptor (DTA104A61/62).</p> <p>If the system needs to be running under power consumption limitation conditions when an external signal is sent to the unit, this setting defines the level power consumption limitation that will be applied for step 2. The level is according to the table.</p>	—	 (= binary 1)	30%
	1 (default)	 (= binary 2) (default)	40%
	2	 (= binary 4)	50%
	3	—	55%
<p>[2-32] </p> <p>Forced, all time, power consumption limitation operation (no external control adaptor is required to perform power consumption limitation).</p> <p>If the system always needs to be running under power consumption limitation conditions, this setting activates and defines the level power consumption limitation that will be applied continuously. The level is according to the table.</p>	0 (default)	 (= binary 1) (default)	Function not active.
	1	 (= binary 2)	Follows [2-30] setting.
	2	 (= binary 4)	Follows [2-31] setting.
<p>[2-81] (in case of 8 HP)  (= binary [2-41]) (in case of 5 HP)</p> <p>Cooling comfort setting. This setting is used in conjunction with setting [2-8].</p>	0		Eco
	1 (default)	 (default)	Mild
	2		Quick
	3		Powerful
<p>[2-82] (in case of 8 HP)  (= binary [2-42]) (in case of 5 HP)</p> <p>Heating comfort setting. This setting is used in conjunction with setting [2-9].</p>	0		Eco
	1 (default)	 (default)	Mild
	2		Quick
	3		Powerful

### 6.1.9 To connect the PC configurator to the compressor unit

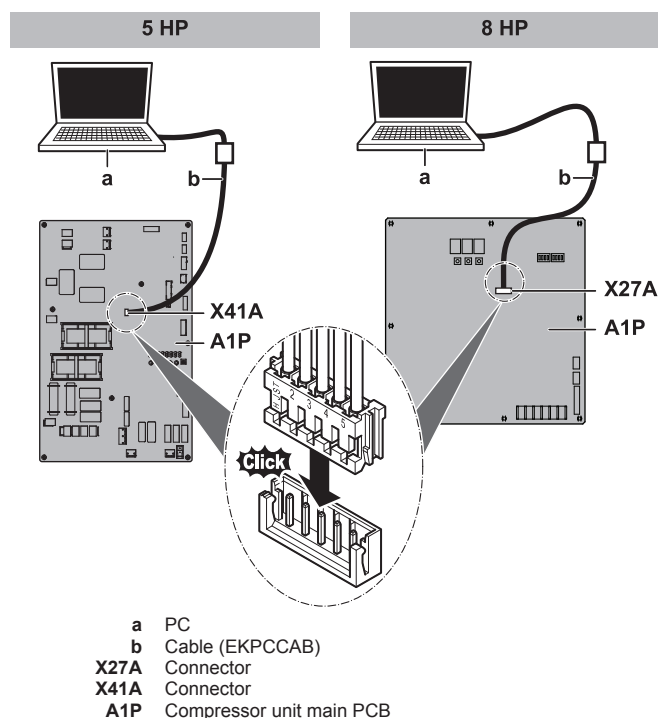

## 7 Commissioning

After installation and once the field settings are defined, the installer is obliged to verify correct operation. Therefore a test run **MUST** be performed according to the procedures described below.

### 7.1 Precautions when commissioning



#### CAUTION

**Do not perform the test operation while working on the indoor units or the heat exchanger unit.**

When performing the test operation, not only the compressor unit will operate, but the heat exchanger unit and the connected indoor units as well. Working on an indoor unit or the heat exchanger unit while performing a test operation is dangerous.



#### NOTICE

Be sure to turn on the power 6 hours before operation in order to have power running to the crankcase heater and to protect the compressor.

During test operation, the compressor unit, the heat exchanger unit and the indoor units will start up. Make sure that the preparations of the heat exchanger unit and all the indoor units are finished (field piping, electrical wiring, air purge, ...). See installation manual of the indoor units for details.

### 7.2 Checklist before commissioning

After the installation of the unit, first check the following items. Once all below checks are fulfilled, the unit **MUST** be closed, **ONLY** then can the unit be powered up.

<input type="checkbox"/>	You read the complete installation and operation instructions, as described in the <b>installer and user reference guide</b> .
--------------------------	--

<input type="checkbox"/>	<b>Installation</b> Check that the unit is properly installed, to avoid abnormal noises and vibrations when starting up the unit.
<input type="checkbox"/>	<b>Field wiring</b> Be sure that the field wiring has been carried out according to the instructions described in the chapter <a href="#">"5.7 Connecting the electrical wiring"</a> on page 18, according to the wiring diagrams and according to the applicable legislation.
<input type="checkbox"/>	<b>Power supply voltage</b> Check the power supply voltage on the local supply panel. The voltage <b>MUST</b> correspond to the voltage on the identification label of the unit.
<input type="checkbox"/>	<b>Earth wiring</b> Be sure that the earth wires have been connected properly and that the earth terminals are tightened.
<input type="checkbox"/>	<b>Insulation test of the main power circuit</b> Using a megatester for 500 V, check that the insulation resistance of 2 MΩ or more is attained by applying a voltage of 500 V DC between power terminals and earth. <b>NEVER</b> use the megatester for the transmission wiring.
<input type="checkbox"/>	<b>Fuses, circuit breakers, or protection devices</b> Check that the fuses, circuit breakers, or the locally installed protection devices are of the size and type specified in the chapter <a href="#">"4.3.2 Safety device requirements"</a> on page 10. Be sure that neither a fuse nor a protection device has been bypassed.
<input type="checkbox"/>	<b>Internal wiring</b> Visually check the electrical component box and the inside of the unit on loose connections or damaged electrical components.
<input type="checkbox"/>	<b>Pipe size and pipe insulation</b> Be sure that correct pipe sizes are installed and that the insulation work is properly executed.
<input type="checkbox"/>	<b>Stop valves</b> Be sure that the stop valves are open on both liquid and gas side.
<input type="checkbox"/>	<b>Damaged equipment</b> Check the inside of the unit on damaged components or squeezed pipes.
<input type="checkbox"/>	<b>Refrigerant leak</b> Check the inside of the unit on refrigerant leakage. If there is a refrigerant leak, try to repair the leak. If the repair is unsuccessful, call your local dealer. Do not touch any refrigerant which has leaked out from refrigerant piping connections. This may result in frostbite.
<input type="checkbox"/>	<b>Oil leak</b> Check the compressor for oil leakage. If there is an oil leak, try to repair the leak. If the repairing is unsuccessful, call your local dealer.
<input type="checkbox"/>	<b>Air inlet/outlet</b> Check that the air inlet and outlet of the unit is <b>NOT</b> obstructed by paper sheets, cardboard, or any other material.
<input type="checkbox"/>	<b>Additional refrigerant charge</b> The amount of refrigerant to be added to the unit shall be written on the included "Added refrigerant" plate and attached to the rear side of the front cover.

## 7 Commissioning

<input type="checkbox"/>	<b>Installation date and field setting</b> Be sure to keep record of the installation date on the sticker on the rear of the front panel according to EN60335-2-40 and keep record of the contents of the field setting(s).
<input type="checkbox"/>	<b>Insulation and air leaks</b> Make sure the unit is fully insulated and checked for air leaks. <b>Possible consequence:</b> Condensate water might drip.
<input type="checkbox"/>	<b>Drainage</b> Make sure drainage flows smoothly. <b>Possible consequence:</b> Condensate water might drip.
<input type="checkbox"/>	<b>External static pressure</b> Make sure the external static pressure is set. <b>Possible consequence:</b> Insufficient cooling or heating.

### 7.3 Checklist during commissioning

<input type="checkbox"/>	To perform a <b>test run</b> .
--------------------------	--------------------------------

#### 7.3.1 About test run

The procedure below describes the test operation of the complete system. This operation checks and judges following items:

- Check of wrong wiring (communication check with indoor units and heat exchanger unit).
- Check of the stop valves opening.
- Check of wrong piping. **Example:** Gas or liquid pipes switched.
- Judgement of piping length.

Make sure to carry out the system test operation after the first installation. Otherwise, the malfunction code  $U3$  will be displayed on the user interface and normal operation or individual indoor unit test run cannot be carried out.

Abnormalities on indoor units cannot be checked for each unit separately. After the test operation is finished, check the indoor units one by one by performing a normal operation using the user interface. Refer to the indoor unit installation manual for more details concerning the individual test run.

#### INFORMATION

- It may take 10 minutes to achieve a uniform refrigerant state before the compressor starts.
- During the test operation, the refrigerant running sound or the magnetic sound of a solenoid valve may become loud and the display indication may change. These are not malfunctions.

#### 7.3.2 To perform a test run (7-LEDs display)

(in case of 5 HP)

- 1 Make sure all field settings you want are set; see ["6.1 Making field settings" on page 19](#).
- 2 Turn ON the power to the compressor unit, heat exchanger unit, and the connected indoor units.







#### NOTICE

Be sure to turn on the power 6 hours before operation in order to have power running to the crankcase heater and to protect the compressor.

- 3 Make sure the default (idle) situation is existing (H1P is OFF); see ["6.1.4 To access mode 1 or 2" on page 21](#). Push BS4 for 5 seconds or more. The unit will start test operation.

**Result:** The test operation is automatically carried out, the compressor unit H2P flashes and the indication "Test operation" and "Under centralised control" will display on the user interface of indoor units.

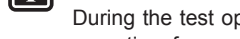
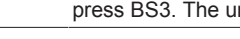

Steps during the automatic system test run procedure:

Step	Description
	Control before start up (pressure equalisation)
	Cooling start up control
	Cooling stable condition
	Communication check
	Stop valve check
	Pipe length check
	Pump down operation
	Unit stop

#### INFORMATION

During the test operation, it is not possible to stop the unit operation from a user interface. To abort the operation, press BS3. The unit will stop after  $\pm 30$  seconds.

- 4 Check the test operation results on the compressor unit 7-LEDs display.

Completion	Description
Normal completion	
Abnormal completion	 Refer to <a href="#">"7.3.4 Correcting after abnormal completion of the test run" on page 29</a> to take actions for correcting the abnormality. When the test operation is fully completed, normal operation will be possible after 5 minutes.

#### 7.3.3 To perform a test run (7-segments display)

(in case of 8 HP)

- 1 Make sure all field settings you want are set; see ["6.1 Making field settings" on page 19](#).
- 2 Turn ON the power to the compressor unit, heat exchanger unit, and the connected indoor units.

#### NOTICE

Be sure to turn on the power 6 hours before operation in order to have power running to the crankcase heater and to protect the compressor.

- 3 Make sure the default (idle) situation is existing; see ["6.1.4 To access mode 1 or 2" on page 21](#). Push BS2 for 5 seconds or more. The unit will start test operation.

**Result:** The test operation is automatically carried out, the compressor unit display will indicate " $E0$ " and the indication "Test operation" and "Under centralised control" will display on the user interface of indoor units.

Steps during the automatic system test run procedure:

Step	Description
$E01$	Control before start up (pressure equalisation)
$E02$	Cooling start up control
$E03$	Cooling stable condition
$E04$	Communication check
$E05$	Stop valve check
$E06$	Pipe length check
$E09$	Pump down operation



Step	Description
E 10	Unit stop

### **i** INFORMATION

During the test operation, it is not possible to stop the unit operation from a user interface. To abort the operation, press BS3. The unit will stop after ±30 seconds.

- 4 Check the test operation results on the compressor unit 7-segment display.

Completion	Description
Normal completion	No indication on the 7-segment display (idle).
Abnormal completion	Indication of malfunction code on the 7-segment display.  Refer to "7.3.4 Correcting after abnormal completion of the test run" on page 29 to take actions for correcting the abnormality. When the test operation is fully completed, normal operation will be possible after 5 minutes.

### 7.3.4 Correcting after abnormal completion of the test run

The test operation is only completed if there is no malfunction code displayed. In case of a displayed malfunction code, perform correcting actions as explained in the malfunction code table. Carry out the test operation again and confirm that the abnormality is properly corrected.

### **i** INFORMATION

If a malfunction occurs:

- In case of 5 HP: The error code is displayed on the user interface of the indoor unit.
- In case of 8 HP: The error code is displayed on the compressor unit's 7-segments display and on the user interface of the indoor unit.

### **i** INFORMATION

Refer to the installation manual of the indoor unit for detailed malfunction codes related to indoor units.

### 8.1.1 Error codes: Overview

In case of 5 HP:

Main code	Cause	Solution
E0	<ul style="list-style-type: none"> <li>▪ Heat exchanger fan malfunction.</li> <li>▪ Drain pump feedback contact is open.</li> </ul>	In the heat exchanger unit: <ul style="list-style-type: none"> <li>▪ Check connection on PCB: A1P (X15A)</li> <li>▪ Check connection on terminal block (X2M)</li> <li>▪ Check the fan connectors.</li> </ul>
E3	<ul style="list-style-type: none"> <li>▪ The stop valves of the compressor unit are left closed.</li> <li>▪ Refrigerant overcharge</li> </ul>	<ul style="list-style-type: none"> <li>▪ Open the stop valves on both the gas and liquid side.</li> <li>▪ Recalculate the required amount of refrigerant from the piping length and correct the refrigerant charge level by recovering any excessive refrigerant with a refrigerant recovery machine.</li> </ul>
E4	<ul style="list-style-type: none"> <li>▪ The stop valves of the compressor unit are left closed.</li> <li>▪ Insufficient refrigerant</li> </ul>	<ul style="list-style-type: none"> <li>▪ Open the stop valves on both the gas and liquid side.</li> <li>▪ Check if the additional refrigerant charge has been finished correctly. Recalculate the required amount of refrigerant from the piping length and add an adequate amount of refrigerant.</li> </ul>
E9	Electronic expansion valve malfunction Heat exchanger unit: (Y1E) - A1P (X7A) Compressor unit: (Y1E) - A1P (X22A)	Check connection on PCB or actuator.

### 7.3.5 Operating the unit

Once the units are installed and test operation of compressor unit, heat exchanger unit and indoor units is finished, the operation of the system can start.

For operating the indoor unit, the user interface of the indoor unit should be switched ON. Refer to the indoor unit operation manual for more details.

## 8 Troubleshooting

### 8.1 Solving problems based on error codes

In case of a displayed malfunction code, perform correcting actions as explained in the malfunction code table.



After correcting the abnormality, press BS3 to reset the malfunction code and retry operation.

### **i** INFORMATION

If a malfunction occurs:

- In case of 5 HP: The error code is displayed on the user interface of the indoor unit.
- In case of 8 HP: The error code is displayed on the compressor unit's 7-segments display and on the user interface of the indoor unit.

In case of 8 HP: The error code on the compressor unit will indicate a main malfunction code and a sub code. The sub code indicates more detailed information about the malfunction code. The main code and sub code will be displayed intermittent (with an interval of 1 second). **Example:**

- Main code: 
- Sub code: 

## 8 Troubleshooting

Main code	Cause	Solution
F3	<ul style="list-style-type: none"> <li>The stop valves of the compressor unit are left closed.</li> <li>Insufficient refrigerant</li> </ul>	<ul style="list-style-type: none"> <li>Open the stop valves on both the gas and liquid side.</li> <li>Check if the additional refrigerant charge has been finished correctly. Recalculate the required amount of refrigerant from the piping length and add an adequate amount of refrigerant.</li> </ul>
F6	Refrigerant overcharge	Recalculate the required amount of refrigerant from the piping length and correct the refrigerant charge level by recovering any excessive refrigerant with a refrigerant recovery machine.
H9	Ambient temperature sensor malfunction Heat exchanger unit: (R1T) - A1P (X16A)	Check connection on PCB or actuator.
J3	Discharge temperature sensor malfunction: open circuit / short circuit Compressor unit: (R2T) - A1P (X12A)	Check connection on PCB or actuator.
J4	Heat exchanger gas sensor malfunction Heat exchanger unit: (R2T) - A1P (X18A)	Check connection on PCB or actuator.
J5	Suction temperature sensor malfunction Compressor unit: (R3T) - A1P (X12A) Compressor unit: (R5T) - A1P (X12A)	Check connection on PCB or actuator.
J6	Coil temperature sensor malfunction Heat exchanger unit: (R3T) - A1P (X17A)	Check connection on PCB or actuator.
J7	Liquid temperature sensor (after subcool HE) malfunction Compressor unit: (R7T) - A1P (X13A)	Check connection on PCB or actuator.
J9	Gas temperature sensor (after subcool HE) malfunction Compressor unit: (R4T) - A1P (X12A)	Check connection on PCB or actuator.
JA	High pressure sensor malfunction: open circuit / short circuit Compressor unit: (BIPH) - A1P (X17A)	Check connection on PCB or actuator.
JC	Low pressure sensor malfunction: open circuit / short circuit Compressor unit: (BIPL) - A1P (X18A)	Check connection on PCB or actuator.
LC	Transmission compressor unit - inverter: INV1 transmission trouble	Check connection.
P1	INV1 unbalanced power supply voltage	Check if power supply is within range.
PJ	Heat exchanger unit capacity setting malfunction.	Check the type of heat exchanger unit. If necessary, replace the heat exchanger unit.
U2	Insufficient supply voltage	Check if the supply voltage is supplied properly.
U3	Malfunction code: System test run not yet executed (system operation not possible)	Execute system test run.
U4	<ul style="list-style-type: none"> <li>No power is supplied to the compressor unit.</li> <li>Transmission wiring malfunction</li> </ul>	<ul style="list-style-type: none"> <li>Check if all units are powered on.</li> <li>Check the transmission wiring.</li> </ul>
U9	<ul style="list-style-type: none"> <li>System mismatch. Wrong type of indoor units combined (R410A, R407C, RA, etc). Indoor unit malfunction</li> <li>Heat exchanger unit malfunction</li> </ul>	<ul style="list-style-type: none"> <li>Check if other indoor units have malfunction and confirm indoor unit mix is allowed.</li> <li>Check the transmission wiring to the heat exchanger unit.</li> </ul>
UR	<ul style="list-style-type: none"> <li>Improper type of indoor units are connected.</li> <li>Mismatch of compressor unit and heat exchanger unit.</li> </ul>	<ul style="list-style-type: none"> <li>Check the type of indoor units that are currently connected. If they are not proper, replace them with proper ones.</li> <li>Check if the compressor unit and heat exchanger unit are compatible.</li> </ul>
UF	<ul style="list-style-type: none"> <li>The stop valves of the compressor unit are left closed.</li> <li>The piping and wiring of the specified indoor unit or heat exchanger unit are not connected correctly to the compressor unit.</li> </ul>	<ul style="list-style-type: none"> <li>Open the stop valves on both the gas and liquid side.</li> <li>Confirm that the piping and wiring of the specified indoor unit or heat exchanger unit are connected correctly to the compressor unit.</li> </ul>

**In case of 8 HP:**

Main code	Sub code	Cause	Solution
E0	-02	<ul style="list-style-type: none"> <li>▪ Heat exchanger fan malfunction.</li> <li>▪ Drain pump feedback contact is open.</li> </ul>	In the heat exchanger unit: <ul style="list-style-type: none"> <li>▪ Check connection on PCB: A1P (X15A)</li> <li>▪ Check connection on terminal block (X2M)</li> <li>▪ Check the fan connectors.</li> </ul>
E2	-01	Earth leakage detector activated Compressor unit: (T1A) - A1P (X101A)	Restart the unit. If the problem reoccurs, contact your dealer.
	-05	No earth leakage detector detected Compressor unit: (T1A) - A1P (X101A)	Replace the earth leakage detector.
E3	-01	High pressure switch was activated Compressor unit: (S1PH) - A1P (X4A)	Check stop valve situation or abnormalities in (field) piping or airflow over air cooled coil.
	-02	<ul style="list-style-type: none"> <li>▪ Refrigerant overcharge</li> <li>▪ Stop valve closed</li> </ul>	<ul style="list-style-type: none"> <li>▪ Check refrigerant amount+recharge unit.</li> <li>▪ Open stop valves</li> </ul>
	-13	Stop valve closed (liquid)	Open liquid stop valve.
	-18	<ul style="list-style-type: none"> <li>▪ Refrigerant overcharge</li> <li>▪ Stop valve closed</li> </ul>	<ul style="list-style-type: none"> <li>▪ Check refrigerant amount+recharge unit.</li> <li>▪ Open stop valves.</li> </ul>
E4	-01	Low pressure malfunction: <ul style="list-style-type: none"> <li>▪ Stop valve closed</li> <li>▪ Refrigerant shortage</li> <li>▪ Indoor unit malfunction</li> </ul>	<ul style="list-style-type: none"> <li>▪ Open stop valves.</li> <li>▪ Check refrigerant amount+recharge unit.</li> <li>▪ Check the user interface's display or transmission wiring between the outdoor unit and the indoor unit.</li> </ul>
E9	-01	Electronic expansion valve malfunction (subcool) Compressor unit: (Y1E) - A1P (X21A)	Check connection on PCB or actuator.
	-47	Electronic expansion valve malfunction (main) Heat exchanger unit: (Y1E) - A1P (X7A)	Check connection on PCB or actuator.
F3	-01	Discharge temperature too high: <ul style="list-style-type: none"> <li>▪ Stop valve closed</li> <li>▪ Refrigerant shortage</li> </ul> Compressor unit: (R21T) - A1P (X29A)	<ul style="list-style-type: none"> <li>▪ Open stop valves.</li> <li>▪ Check refrigerant amount+recharge unit.</li> </ul>
F5	-02	<ul style="list-style-type: none"> <li>▪ Refrigerant overcharge</li> <li>▪ Stop valve closed</li> </ul>	<ul style="list-style-type: none"> <li>▪ Check refrigerant amount+recharge unit.</li> <li>▪ Open stop valves.</li> </ul>
H9	-01	Ambient temperature sensor malfunction Heat exchanger unit: (R1T) - A1P (X16A)	Check connection on PCB or actuator.
J3	-15	Discharge temperature sensor malfunction Compressor unit: (R21T): open circuit - A1P (X29A)	Check connection on PCB or actuator.
	-17	Discharge temperature sensor malfunction Compressor unit: (R21T): short circuit - A1P (X29A)	Check connection on PCB or actuator.
J4	-01	Heat exchanger gas sensor malfunction Heat exchanger unit: (R2T) - A1P (X18A)	Check connection on PCB or actuator.
J5	-01	Suction temperature sensor malfunction Compressor unit: (R3T) - A1P (X30A)	Check connection on PCB or actuator.
	-02	Suction temperature sensor malfunction Compressor unit: (R7T) - A1P (X30A)	Check connection on PCB or actuator.
J6	-01	De-icing temperature sensor malfunction Heat exchanger unit: (R3T) - A1P (X17A)	Check connection on PCB or actuator
J7	-05	Liquid temperature sensor (after subcool HE) malfunction Compressor unit: (R5T) - A1P (X30A)	Check connection on PCB or actuator.
J9	-01	Gas temperature sensor (after subcool HE) malfunction Compressor unit: (R6T) - A1P (X30A)	Check connection on PCB or actuator.

## 8 Troubleshooting

Main code	Sub code	Cause	Solution
JR	-06	High pressure sensor malfunction Compressor unit: (S1NPH): open circuit - A1P (X32A)	Check connection on PCB or actuator.
	-07	High pressure sensor malfunction Compressor unit: (S1NPH): short circuit - A1P (X32A)	Check connection on PCB or actuator.
JC	-06	Low pressure sensor malfunction Compressor unit: (S1NPL): open circuit - A1P (X31A)	Check connection on PCB or actuator.
	-07	Low pressure sensor malfunction Compressor unit: (S1NPL): short circuit - A1P (X31A)	Check connection on PCB or actuator.
LC	- 14	Transmission outdoor unit - inverter: INV1 transmission trouble Compressor unit: A1P (X20A, X28A, X42A)	Check connection.
PI	-01	INV1 unbalanced power supply voltage	Check if power supply is within range.
PJ	-01	Heat exchanger unit capacity setting malfunction.	Check the type of heat exchanger unit. If necessary, replace the heat exchanger unit.
U1	-01	Reversed power supply phase malfunction	Correct phase order.
	-04	Reversed power supply phase malfunction	Correct phase order.
U2	-01	INV1 voltage power shortage	Check if power supply is within range.
	-02	INV1 power phase loss	Check if power supply is within range.
U3	-03	Malfunction code: System test run not yet executed (system operation not possible)	Execute system test run.
U4	-01	Faulty wiring to Q1/Q2 or indoor - outdoor	Check (Q1/Q2) wiring. Do NOT use Q1/Q2.
	-03	Faulty wiring to Q1/Q2 or indoor - outdoor	Check (Q1/Q2) wiring. Do NOT use Q1/Q2.
	-04	System test run abnormal ending	Execute test run again.
U7	-01	Warning: faulty wiring to Q1/Q2	Check Q1/Q2 wiring. Do NOT use Q1/Q2.
	-02	Malfunction code: faulty wiring to Q1/Q2	Check Q1/Q2 wiring. Do NOT use Q1/Q2.
	- 11	<ul style="list-style-type: none"> <li>▪ Too many indoor units are connected to F1/F2 line</li> <li>▪ Bad wiring between outdoor and indoor units</li> </ul>	Check indoor unit amount and total capacity connected.
U9	-01	<ul style="list-style-type: none"> <li>▪ System mismatch. Wrong type of indoor units combined (R410A, R407C, RA, etc). Indoor unit malfunction</li> <li>▪ Heat exchanger unit malfunction</li> </ul>	<ul style="list-style-type: none"> <li>▪ Check if other indoor units have malfunction and confirm indoor unit mix is allowed.</li> <li>▪ Check the transmission wiring to the heat exchanger unit.</li> </ul>
UR	-03	More than 1 heat exchanger unit connected.	Check installation. Only 1 heat exchanger unit can be installed.
	- 18	<ul style="list-style-type: none"> <li>▪ Improper type of indoor units are connected.</li> <li>▪ Mismatch of compressor unit and heat exchanger unit.</li> </ul>	<ul style="list-style-type: none"> <li>▪ Check the type of indoor units that are currently connected. If they are not proper, replace them with proper ones.</li> <li>▪ Check if the compressor unit and heat exchanger unit are compatible.</li> </ul>
	-21	5 HP heat exchanger unit connected.	Check installation. Connect 8 HP heat exchanger unit.
UH	-01	<ul style="list-style-type: none"> <li>▪ Auto address malfunction (inconsistency)</li> <li>▪ Mismatch of compressor unit and heat exchanger unit.</li> </ul>	<ul style="list-style-type: none"> <li>▪ Check if transmission wired unit amount matches with powered unit amount (by monitor mode) or wait till initialisation is finished.</li> <li>▪ Check if the compressor unit and heat exchanger unit are compatible.</li> </ul>

Main code	Sub code	Cause	Solution
UF	-01	<ul style="list-style-type: none"> <li>Auto address malfunction (inconsistency)</li> <li>Mismatch of compressor unit and heat exchanger unit.</li> </ul>	<ul style="list-style-type: none"> <li>Check if transmission wired unit amount matches with powered unit amount (by monitor mode) or wait till initialisation is finished.</li> <li>Check if the compressor unit and heat exchanger unit are compatible.</li> </ul>
	-05	<ul style="list-style-type: none"> <li>The stop valves of the compressor unit are left closed.</li> <li>The piping and wiring of the specified indoor unit or heat exchanger unit are not connected correctly to the compressor unit.</li> </ul>	<ul style="list-style-type: none"> <li>Open the stop valves on both the gas and liquid side.</li> <li>Confirm that the piping and wiring of the specified indoor unit or heat exchanger unit are connected correctly to the compressor unit.</li> </ul>

## 9 Technical data

- A **subset** of the latest technical data is available on the regional Daikin website (publicly accessible).
- The **full set** of latest technical data is available on the Daikin extranet (authentication required).

### 9.1 Piping diagram: Compressor unit and heat exchanger unit

5 HP

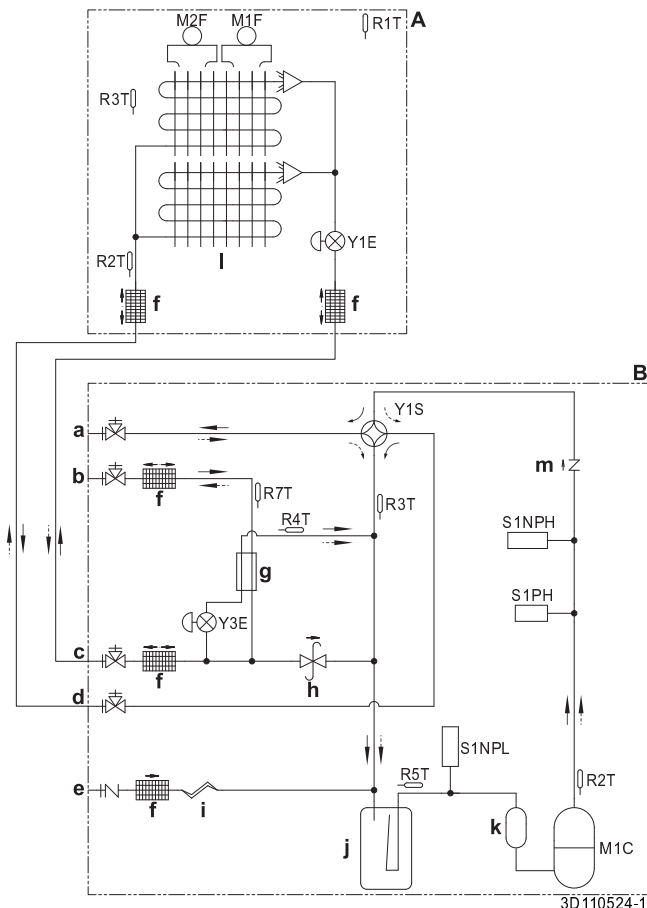

- A Heat exchanger unit
- B Compressor unit
- a Stop valve (gas) (circuit 2: to indoor units)
- b Stop valve (liquid) (circuit 2: to indoor units)
- c Stop valve (liquid) (circuit 1: to heat exchanger unit)
- d Stop valve (gas) (circuit 1: to heat exchanger unit)
- e Service port (refrigerant charge)
- f Filter
- g Subcool heat exchanger
- h Pressure regulating valve
- i Capillary tube
- j Accumulator
- k Compressor accumulator

- I Heat exchanger
- m Check valve
- M1C Compressor
- M1F, M2F Fan motor
- R1T (A) Thermistor (air)
- R2T (A) Thermistor (gas)
- R3T (A) Thermistor (coil)
- R2T (B) Thermistor (discharge)
- R3T (B) Thermistor (suction accumulator)
- R4T (B) Thermistor (subcool heat exchanger gas)
- R5T (B) Thermistor (suction compressor)
- R7T (B) Thermistor (liquid)
- S1NPH High pressure sensor
- S1NPL Low pressure sensor
- S1PH High pressure switch
- Y1E, Y3E Electronic expansion valve
- Y1S Solenoid valve (4-way valve)
- Heating
- ⇝ Cooling

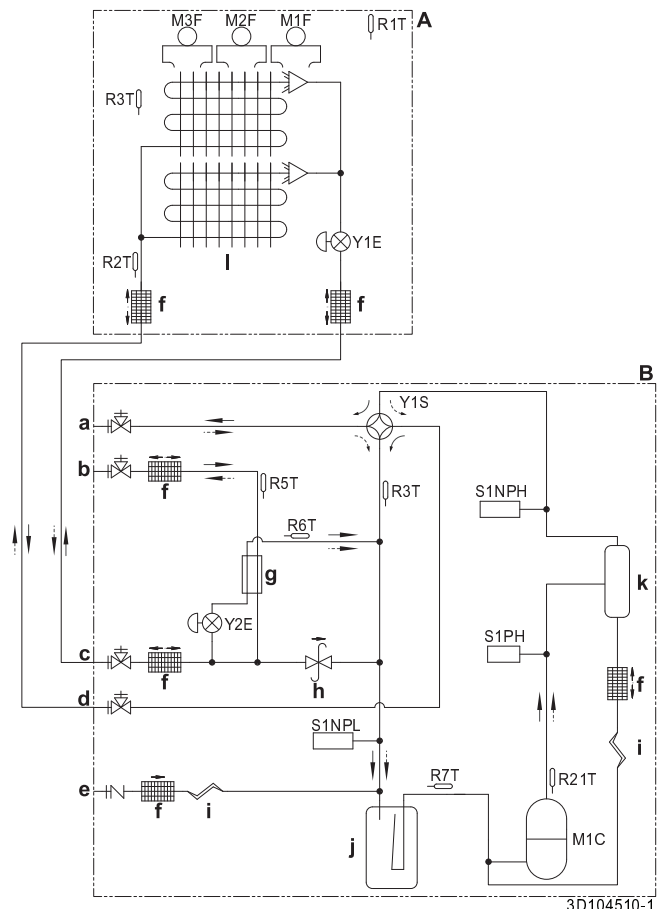

8 HP



- A Heat exchanger unit
- B Compressor unit
- a Stop valve (gas) (circuit 2: to indoor units)
- b Stop valve (liquid) (circuit 2: to indoor units)
- c Stop valve (liquid) (circuit 1: to heat exchanger unit)
- d Stop valve (gas) (circuit 1: to heat exchanger unit)
- e Service port (refrigerant charge)
- f Filter



## 9 Technical data







<b>g</b>	Subcool heat exchanger
<b>h</b>	Pressure regulating valve
<b>i</b>	Capillary tube
<b>j</b>	Accumulator
<b>k</b>	Oil separator
<b>l</b>	Heat exchanger
<b>M1C</b>	Compressor
<b>M1F~M3F</b>	Fan motor
<b>R1T (A)</b>	Thermistor (air)
<b>R2T (A)</b>	Thermistor (gas)
<b>R3T (A)</b>	Thermistor (coil)
<b>R21T (B)</b>	Thermistor (discharge)
<b>R3T (B)</b>	Thermistor (suction accumulator)
<b>R5T (B)</b>	Thermistor (liquid)
<b>R6T (B)</b>	Thermistor (subcool heat exchanger gas)
<b>R7T (B)</b>	Thermistor (suction compressor)
<b>S1NPH</b>	High pressure sensor
<b>S1NPL</b>	Low pressure sensor
<b>S1PH</b>	High pressure switch
<b>Y1E, Y2E</b>	Electronic expansion valve
<b>Y1S</b>	Solenoid valve (4-way valve)
	Heating
	Cooling

<b>R7T</b>	Thermistor (liquid)
<b>R10T</b>	Thermistor (fin)
<b>S1NPL</b>	Low pressure sensor
<b>S1NPH</b>	High pressure sensor
<b>S1PH</b>	High pressure switch
<b>S*S</b>	Cool/heat selector switch (optional)
<b>V1R</b>	IGBT power module (A2P)
<b>V2R</b>	Diode module (A2P)
<b>X1M</b>	Terminal strip (power supply)
<b>X2M</b>	Terminal strip (transmission wiring)
<b>X*Y</b>	Connector
<b>Y3E</b>	Electronic expansion valve
<b>Y1S</b>	Solenoid valve (4-way valve)
<b>Z*C</b>	Noise filter (ferrite core)
<b>Z*F</b>	Noise filter (A1P)

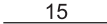
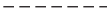
### 9.2 Wiring diagram: Compressor unit

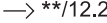
The wiring diagram is delivered with the unit, located on the switch box cover.

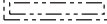
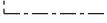
#### Symbols:

<b>X1M</b>	Main terminal
	Earth wiring
	Wire number 15
	Field wire
	Field cable
	Connection ** continues on page 12 column 2
	Several wiring possibilities
	Option
	Not mounted in switch box
	Wiring depending on model
	PCB

#### Legend for wiring diagram 5 HP:

<b>A1P</b>	Printed circuit board (main)
<b>A2P</b>	Printed circuit board (inverter)
<b>BS*</b>	Push button (A1P)
<b>C*</b>	Capacitor (A2P)
<b>DS1</b>	DIP switch (A1P)
<b>F1U, F2U</b>	Fuse (T 31.5 A / 250 V) (A1P)
<b>F3U, F5U</b>	Fuse (T 6.3 A / 250 V) (A1P)
<b>H*P</b>	LED (service monitor orange) (A1P)
<b>HAP</b>	Running LED (service monitor green) (A*P)
<b>K1M</b>	Magnetic contactor (A2P)
<b>K1R</b>	Magnetic relay (A*P)
<b>L1R</b>	Reactor
<b>M1C</b>	Motor (compressor)
<b>M1F</b>	Motor (fan)
<b>PS</b>	Switching power supply (A2P)
<b>Q1DI</b>	Earth leakage circuit breaker (field supply)
<b>R*</b>	Resistor (A2P)
<b>R2T</b>	Thermistor (discharge)
<b>R3T</b>	Thermistor (suction accumulator)
<b>R4T</b>	Thermistor (subcool heat exchanger gas)
<b>R5T</b>	Thermistor (suction compressor)

#### Notes for 8 HP:

- When using the optional adapter, refer to the installation manual of the optional adapter.
- Refer to the installation or service manual on how to use BS1~BS3 push buttons, and DS1+DS2 DIP switches.
- Do not operate the unit by short-circuiting protection device S1PH.
- For connection of INDOOR-OUTDOOR F1-F2 transmission wiring, and OUTDOOR-OUTDOOR F1-F2 transmission wiring, refer to the service manual.

#### Legend for wiring diagram 8 HP:

<b>A1P</b>	Printed circuit board (main)
<b>A2P</b>	Printed circuit board (noise filter)
<b>A3P</b>	Printed circuit board (inverter)
<b>A4P</b>	Printed circuit board (cool/heat selector)
<b>BS*</b>	Push button (mode, set, return) (A1P)
<b>C*</b>	Capacitor (A3P)
<b>DS*</b>	DIP switch (A1P)
<b>E1HC</b>	Crankcase heater
<b>F*U</b>	Fuse (T 3.15 A / 250 V) (A1P)
<b>F3U</b>	Field fuse
<b>F400U</b>	Fuse (T 6.3 A / 250 V) (A2P)
<b>F410U</b>	Fuse (T 40 A / 500 V) (A2P)
<b>F411U</b>	Fuse (T 40 A / 500 V) (A2P)
<b>F412U</b>	Fuse (T 40 A / 500 V) (A2P)
<b>HAP</b>	Running LED (service monitor green) (A1P)
<b>K1M</b>	Magnetic contactor (A3P)
<b>K*R</b>	Magnetic relay (A*P)
<b>L1R</b>	Reactor
<b>M1C</b>	Motor (compressor)
<b>M1F</b>	Motor (fan)
<b>PS</b>	Power supply (A1P, A3P)
<b>Q1DI</b>	Earth leakage circuit breaker (field supply)
<b>Q1RP</b>	Phase reversal detect circuit (A1P)
<b>R21T</b>	Thermistor (M1C discharge)
<b>R3T</b>	Thermistor (accumulator)
<b>R5T</b>	Thermistor (subcool liquid pipe)
<b>R6T</b>	Thermistor (heat exchanger gas pipe)
<b>R7T</b>	Thermistor (suction)

R*	Resistor (A3P)	X37A	Connector (power supply for option PCB) (optional)
S1NPH	High pressure sensor	X66A	Connector (cool/heat selector switch) (optional)
S1NPL	Low pressure sensor	X1M	Terminal strip (power supply)
S1PH	High pressure switch (discharge)	X*A	PCB connector
S1S	Air control switch (optional)	X*M	Terminal strip on PCB (A*P)
S2S	Cool/heat selector switch (optional)	X*Y	Connector
SEG1~SEG3	7-segment display	Y2E	Electronic expansion valve
T1A	Earth leakage detector	Y1S	Solenoid valve (4-way valve)
V1R	IGBT power module (A3P)	Z*C	Noise filter (ferrite core)
V2R	Diode module (A3P)	Z*F	Noise filter

## For the user

### 10 About the system

The VRV IV heat pump for indoor installation can be used for heating/cooling applications.



#### NOTICE

Do not use the system for other purposes. In order to avoid any quality deterioration, do not use the unit for cooling precision instruments, food, plants, animals or works of art.



#### NOTICE

For future modifications or expansions of your system:

A full overview of allowable combinations (for future system extensions) is available in technical engineering data and should be consulted. Contact your installer to receive more information and professional advice.

#### 10.1 System layout

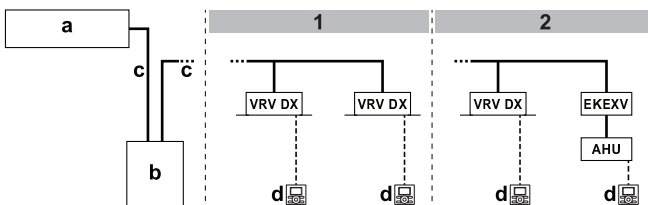

- 1 In case of VRV DX indoor units
- 2 In case of VRV DX indoor units combined with an air handling unit
- a Heat exchanger unit
- b Compressor unit
- c Refrigerant piping
- d User interface (dedicated depending on indoor unit type)
- VRV DX VRV direct expansion (DX) indoor unit
- EKE XV Expansion valve kit
- AHU Air handling unit

### 11 User interface



#### CAUTION

NEVER touch the internal parts of the controller.

Do NOT remove the front panel. Some parts inside are dangerous to touch and appliance problems may happen. For checking and adjusting the internal parts, contact your dealer.

Detailed information on required actions to achieve certain functions can be found in the dedicated installation and operation manual of the indoor unit.

Refer to the operation manual of the installed user interface.

### 12 Operation

#### 12.1 Operation range

Use the system in the following temperature and humidity ranges for safe and effective operation.

Specification		5 HP	8 HP
Maximum capacity	Heating	16.0 kW	25.0 kW
	Cooling	14.0 kW	22.4 kW
Outside ambient design temperature	Heating	-20~15.5°C WB	
	Cooling	-5~46°C DB	
Ambient design temperature of compressor unit and heat exchanger unit		5~35°C DB	
Maximum relative humidity around the compressor unit and heat exchanger unit	Heating	50% <sup>(a)</sup>	
	Cooling	80% <sup>(a)</sup>	

(a) To avoid condensation and water dripping out of the unit. If the temperature or the humidity is beyond these conditions, safety devices may be put in action and the air conditioner may not operate.

Special operation ranges are valid in case of using AHU. They can be found in the installation/operation manual of the dedicated unit. Latest information can be found in the technical engineering data.

#### 12.2 Operating the system

##### 12.2.1 About operating the system

- Operation procedure varies according to the combination of compressor unit, heat exchanger unit, and user interface.
- To protect the unit, turn on the main power switch 6 hours before operation.
- If the main power supply is turned off during operation, operation will restart automatically after the power turns back on again.
- When stopping the unit, the unit might still operate for a few minutes. This is not a malfunction.

## 12 Operation

### 12.2.2 About cooling, heating, fan only, and automatic operation

- Changeover cannot be made with a user interface whose display shows "change-over under centralised control" (refer to installation and operation manual of the user interface).
- When the display "change-over under centralised control" flashes, refer to "12.5.1 About setting the master user interface" on page 37.
- The fan may keep on running for about 1 minute after the heating operation stops.
- The air flow rate may adjust itself depending on the room temperature or the fan may stop immediately. This is not a malfunction.

### 12.2.3 About the heating operation

It may take longer to reach the set temperature for general heating operation than for cooling operation.

The following operation is performed in order to prevent the heating capacity from dropping or cold air from blowing.

#### Defrost operation

In heating operation, freezing of the heat exchanger unit's air cooled coil increases over time, restricting the energy transfer to the heat exchanger unit's coil. Heating capability decreases and the system needs to go into defrost operation to be able to deliver enough heat to the indoor units.

The indoor unit will stop fan operation, the refrigerant cycle will reverse and energy from inside the building will be used to defrost the heat exchanger unit coil.

The indoor unit will indicate defrost operation on the display .

During defrost operation, ice melts and possibly evaporates. **Possible consequence:** Mist might be visible during or directly after defrost operation. This is not a malfunction.

#### Hot start

In order to prevent cold air from blowing out of an indoor unit at the start of heating operation, the indoor fan is automatically stopped. The display of the user interface shows . It may take some time before the fan starts. This is not a malfunction.

### 12.2.4 To operate the system (WITHOUT cool/heat changeover remote control switch)

- Press the operation mode selector button on the user interface several times and select the operation mode of your choice.

- Cooling operation
- Heating operation
- Fan only operation

- Press the ON/OFF button on the user interface.

**Result:** The operation lamp lights up and the system starts operating.

### 12.2.5 To operate the system (WITH cool/heat changeover remote control switch)

#### Overview of the changeover remote control switch

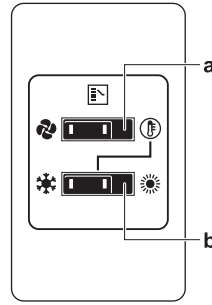

#### a FAN ONLY/AIR CONDITIONING SELECTOR SWITCH

Set the switch to for fan only operation or to for heating or cooling operation.

#### b COOL/HEAT CHANGEOVER SWITCH

Set the switch to for cooling or to for heating

#### To start

- Select operation mode with the cool/heat changeover switch as follows:

Cooling operation



Heating operation



Fan only operation

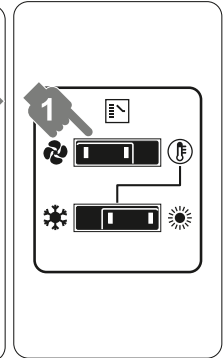
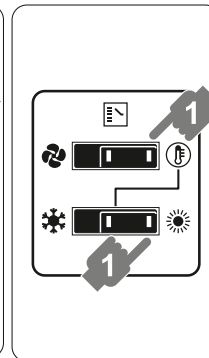
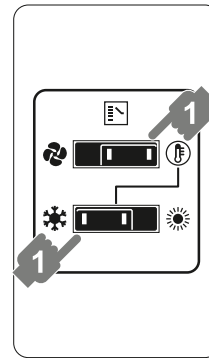

- Press the ON/OFF button on the user interface.

**Result:** The operation lamp lights up and the system starts operating.

#### To stop

- Press the ON/OFF button on the user interface once again.

**Result:** The operation lamp goes out and the system stops operating.



#### NOTICE

Do not turn off power immediately after the unit stops, but wait for at least 5 minutes.

#### To adjust

For programming temperature, fan speed and air flow direction refer to the operation manual of the user interface.

## 12.3 Using the dry program

### 12.3.1 About the dry program

- The function of this program is to decrease the humidity in your room with minimal temperature decrease (minimal room cooling).
- The micro computer automatically determines temperature and fan speed (cannot be set by the user interface).
- The system does not go into operation if the room temperature is low (<20°C).

### 12.3.2 To use the dry program (WITHOUT cool/heat changeover remote control switch)

**To start**

- 1 Press the operation mode selector button on the user interface several times and select (program dry operation).
- 2 Press the ON/OFF button of the user interface.  
**Result:** The operation lamp lights up and the system starts operating.
- 3 Press the air flow direction adjust button (only for double-flow, multi-flow, corner, ceiling-suspended and wall-mounted). Refer to "12.4 Adjusting the air flow direction" on page 37 for details.

**To stop**

- 4 Press the ON/OFF button on the user interface once again.

**Result:** The operation lamp goes out and the system stops operating.



**NOTICE**

Do not turn off power immediately after the unit stops, but wait for at least 5 minutes.

### 12.3.3 To use the dry program (WITH cool/heat changeover remote control switch)

**To start**

- 1 Select cooling operation mode with the cool/heat changeover remote control switch.

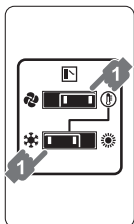

- 2 Press the operation mode selector button on the user interface several times and select (program dry operation).
- 3 Press the ON/OFF button of the user interface.  
**Result:** The operation lamp lights up and the system starts operating.
- 4 Press the air flow direction adjust button (only for double-flow, multi-flow, corner, ceiling-suspended and wall-mounted). Refer to "12.4 Adjusting the air flow direction" on page 37 for details.

**To stop**

- 5 Press the ON/OFF button on the user interface once again.

**Result:** The operation lamp goes out and the system stops operating.



**NOTICE**

Do not turn off power immediately after the unit stops, but wait for at least 5 minutes.

## 12.4 Adjusting the air flow direction

Refer to the operation manual of the user interface.

### 12.4.1 About the air flow flap

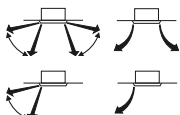

Double flow+multi-flow units

Corner units

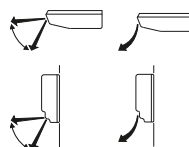

Ceiling suspended units

Wall-mounted units

For the following conditions, a micro computer controls the air flow direction which may be different from the display.

Cooling	Heating
<ul style="list-style-type: none"> <li>When the room temperature is lower than the set temperature.</li> </ul>	<ul style="list-style-type: none"> <li>When starting operation.</li> <li>When the room temperature is higher than the set temperature.</li> <li>At defrost operation.</li> </ul>
<ul style="list-style-type: none"> <li>When operating continuously at horizontal air flow direction.</li> </ul>	
<ul style="list-style-type: none"> <li>When continuous operation with downward air flow is performed at the time of cooling with a ceiling-suspended or a wall-mounted unit, the micro computer may control the flow direction, and then the user interface indication will also change.</li> </ul>	

The air flow direction can be adjusted in one of the following ways:

- The air flow flap itself adjusts its position.
- The air flow direction can be fixed by the user.
- Automatic and desired position .



**WARNING**

Never touch the air outlet or the horizontal blades while the swing flap is in operation. Fingers may become caught or the unit may break down.



**NOTICE**

- The movable limit of the flap is changeable. Contact your dealer for details. (only for double-flow, multi-flow, corner, ceiling-suspended and wall-mounted).
- Avoid operating in the horizontal direction . It may cause dew or dust to settle on the ceiling or flap.

## 12.5 Setting the master user interface

### 12.5.1 About setting the master user interface

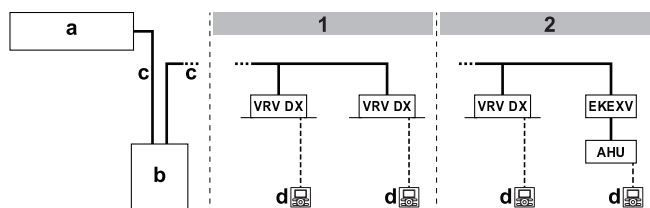

- 1 In case of VRV DX indoor units
  - 2 In case of VRV DX indoor units combined with an air handling unit
- a** Heat exchanger unit  
**b** Compressor unit  
**c** Refrigerant piping  
**d** User interface (dedicated depending on indoor unit type)  
**VRV DX** VRV direct expansion (DX) indoor unit  
**EKE XV** Expansion valve kit  
**AHU** Air handling unit

When the system is installed as shown in the figure above, it is necessary to designate one of the user interfaces as the master user interface.

The displays of slave user interfaces show (change-over under centralised control) and slave user interfaces automatically follow the operation mode directed by the master user interface.

Only the master user interface can select heating or cooling mode.



## 13 Maintenance and service

### 12.5.2 To designate the master user interface (VRV DX)

- 1 Press the operation mode selector button of the current master user interface for 4 seconds. In case this procedure was not yet performed, the procedure can be executed on the first user interface operated.

**Result:** The display showing  (change-over under centralised control) of all slave user interfaces connected to the same compressor unit flashes.

- 2 Press the operation mode selector button of the controller that you wish to designate as the master user interface.

**Result:** Designation is completed. This user interface is designated as the master user interface and the display showing  (change-over under centralised control) vanishes. The displays of other user interfaces show  (change-over under centralised control).

## 13 Maintenance and service



### NOTICE

Never inspect or service the unit by yourself. Ask a qualified service person to perform this work.



### WARNING

Never replace a fuse with a fuse of a wrong ampere ratings or other wires when a fuse blows out. Use of wire or copper wire may cause the unit to break down or cause a fire.



### CAUTION

Do not insert fingers, rods or other objects into the air inlet or outlet. Do not remove the fan guard. When the fan is rotating at high speed, it will cause injury.



### CAUTION

After a long use, check the unit stand and fitting for damage. If damaged, the unit may fall and result in injury.



### NOTICE

Do not wipe the controller operation panel with benzene, thinner, chemical dust cloth, etc. The panel may get discoloured or the coating peeled off. If it is heavily dirty, soak a cloth in water-diluted neutral detergent, squeeze it well and wipe the panel clean. Wipe it with another dry cloth.

### Water pressure

Check whether the water pressure is above 1 bar. If it is lower, add water.

### 13.1 About the refrigerant

This product contains fluorinated greenhouse gases. Do NOT vent gases into the atmosphere.

Refrigerant type: R410A

Global warming potential (GWP) value: 2087.5



### NOTICE

In Europe, the **greenhouse gas emissions** of the total refrigerant charge in the system (expressed as tonnes CO<sub>2</sub>-equivalent) is used to determine the maintenance intervals. Follow the applicable legislation.

**Formula to calculate the greenhouse gas emissions:**  
GWP value of the refrigerant × Total refrigerant charge [in kg] / 1000

Please contact your installer for more information.



### WARNING

The refrigerant in the system is safe and normally does not leak. If the refrigerant leaks in the room, contact with a fire of a burner, a heater or a cooker may result in a harmful gas.

Turn off any combustible heating devices, ventilate the room and contact the dealer where you purchased the unit.

Do not use the system until a service person confirms that the portion where the refrigerant leaks is repaired.

## 13.2 After-sales service and warranty

### 13.2.1 Warranty period

- This product includes a warranty card that was filled in by the dealer at the time of installation. The completed card has to be checked by the customer and stored carefully.
- If repairs to the product are necessary within the warranty period, contact your dealer and keep the warranty card at hand.

### 13.2.2 Recommended maintenance and inspection

Since dust collects when using the unit for several years, performance of the unit will deteriorate to some extent. As taking apart and cleaning interiors of units requires technical expertise and in order to ensure the best possible maintenance of your units, we recommend to enter into a maintenance and inspection contract on top of normal maintenance activities. Our network of dealers has access to a permanent stock of essential components in order to keep your unit in operation as long as possible. Contact your dealer for more information.

**When asking your dealer for an intervention, always state:**

- The complete model name of the unit.
- The manufacturing number (stated on the nameplate of the unit).
- The installation date.
- The symptoms or malfunction, and details of the defect.



### WARNING

- Do not modify, disassemble, remove, reinstall or repair the unit yourself as incorrect dismantling or installation may cause an electric shock or fire. Contact your dealer.
- In case of accidental refrigerant leaks, make sure there are no naked flames. The refrigerant itself is entirely safe, non-toxic and non-combustible, but it will generate toxic gas when it accidentally leaks into a room where combustible air from fan heaters, gas cookers, etc. is present. Always have qualified service personnel confirm that the point of leakage has been repaired or corrected before resuming operation.



## 14 Troubleshooting

If one of the following malfunctions occur, take the measures shown below and contact your dealer.



### WARNING

**Stop operation and shut off the power if anything unusual occurs (burning smells etc.).**

Leaving the unit running under such circumstances may cause breakage, electric shock or fire. Contact your dealer.

The system must be repaired by a qualified service person:

Malfunction	Measure
If a safety device such as a fuse, a breaker or an earth leakage breaker frequently actuates or the ON/OFF switch does not properly work.	Turn off the main power switch.
If water leaks from the unit.	Stop the operation.
The operation switch does not work well.	Turn off the power.
If the user interface display indicates the unit number, the operation lamp flashes and the malfunction code appears.	Notify your installer and report the malfunction code.

If the system does not properly operate except for the above mentioned cases and none of the above mentioned malfunctions is evident, investigate the system according to the following procedures.

Malfunction	Measure
If the system does not operate at all.	<ul style="list-style-type: none"> <li>Check if there is no power failure. Wait until power is restored. If power failure occurs during operation, the system automatically restarts immediately after power is restored.</li> <li>Check if no fuse has blown or breaker is activated. Change the fuse or reset the breaker if necessary.</li> </ul>
If the system goes into fan only operation, but as soon as it goes into heating or cooling operation, the system stops.	<ul style="list-style-type: none"> <li>Check if air inlet or outlet of heat exchanger unit or indoor unit is not blocked by obstacles. Remove any obstacles and make sure the air can flow freely.</li> <li>Check if the user interface display shows  (time to clean the air filter). (Refer to "13 Maintenance and service" on page 38 and "Maintenance" in the indoor unit manual.)</li> </ul>

Malfunction	Measure
The system operates but cooling or heating is insufficient.	<ul style="list-style-type: none"> <li>Check if air inlet or outlet of heat exchanger unit or indoor unit is not blocked by obstacles. Remove any obstacle and make it well-ventilated.</li> <li>Check if the air filter is not clogged (refer to "Maintenance" in the indoor unit manual).</li> <li>Check the temperature setting.</li> <li>Check the fan speed setting on your user interface.</li> <li>Check for open doors or windows. Close doors and windows to prevent wind from coming in.</li> <li>Check if there are too many occupants in the room during cooling operation. Check if the heat source of the room is excessive.</li> <li>Check if direct sunlight enters the room. Use curtains or blinds.</li> <li>Check if the air flow angle is proper.</li> </ul>

If after checking all above items, it is impossible to fix the problem yourself, contact your installer and state the symptoms, the complete model name of the unit (with manufacturing number if possible) and the installation date (possibly listed on the warranty card).

### 14.1 Error codes: Overview

In case a malfunction code appears on the indoor unit user interface display, contact your installer and inform the malfunction code, the unit type, and serial number (you can find this information on the nameplate of the unit).

For your reference, a list with malfunction codes is provided. You can, depending on the level of the malfunction code, reset the code by pushing the ON/OFF button. If not, ask your installer for advice.

Main code	Contents
<i>P0</i>	External protection device was activated
<i>P1</i>	EEPROM failure (indoor)
<i>P3</i>	Drain system malfunction (indoor)
<i>P5</i>	Fan motor malfunction (indoor)
<i>P7</i>	Swing flap motor malfunction (indoor)
<i>P9</i>	Expansion valve malfunction (indoor)
<i>PF</i>	Drain malfunction (indoor unit)
<i>PH</i>	Filter dust chamber malfunction (indoor)
<i>PJ</i>	Capacity setting malfunction (indoor)
<i>C1</i>	Transmission malfunction between main PCB and sub PCB (indoor)
<i>C4</i>	Heat exchanger thermistor malfunction (indoor; liquid)
<i>C5</i>	Heat exchanger thermistor malfunction (indoor; gas)
<i>C9</i>	Suction air thermistor malfunction (indoor)
<i>CA</i>	Discharge air thermistor malfunction (indoor)
<i>CE</i>	Movement detector or floor temperature sensor malfunction (indoor)
<i>CJ</i>	User interface thermistor malfunction (indoor)
<i>E0</i>	Fan or drain pump malfunction (heat exchanger unit)
<i>E1</i>	PCB malfunction (compressor unit)
<i>E2</i>	Current leakage detector was activated (compressor unit)
<i>E3</i>	High pressure switch was activated
<i>E4</i>	Low pressure malfunction (compressor unit)

## 14 Troubleshooting

Main code	Contents
E5	Compressor lock detection (compressor unit)
E9	Electronic expansion valve malfunction (compressor unit or heat exchanger unit)
F3	Discharge temperature malfunction (compressor unit)
F4	Abnormal suction temperature (compressor unit)
F6	Refrigerant overcharge detection
H3	High pressure switch malfunction
H4	Low pressure switch malfunction
H9	Ambient temperature sensor malfunction (heat exchanger unit)
J1	Pressure sensor malfunction
J2	Current sensor malfunction
J3	Discharge temperature sensor malfunction (compressor unit)
J4	Heat exchanger gas temperature sensor malfunction (heat exchanger unit)
J5	Suction temperature sensor malfunction (compressor unit)
J6	De-icing temperature sensor malfunction (heat exchanger unit)
J7	Liquid temperature sensor (after subcool HE) malfunction (compressor unit)
J9	Gas temperature sensor (after subcool HE) malfunction (compressor unit)
JR	High pressure sensor malfunction (BIPH)
JL	Low pressure sensor malfunction (BIPL)
L1	INV PCB abnormal
L4	Fin temperature abnormal
L5	Inverter PCB faulty
L8	Compressor over current detected
L9	Compressor lock (startup)
LC	Transmission compressor unit - inverter: INV transmission trouble
P1	INV unbalanced power supply voltage
P4	Fin thermistor malfunction
PJ	Heat exchanger unit capacity setting malfunction.
UD	Abnormal low pressure drop, faulty expansion valve
U1	Reversed power supply phase malfunction
U2	INV voltage power shortage
U3	System test run not yet executed
U4	Faulty wiring indoor/heat exchanger unit/compressor unit
U5	Abnormal user interface - indoor communication
UB	Abnormal main-sub user interface communication
U9	System mismatch. Wrong type of indoor units combined. Indoor unit malfunction. Heat exchanger unit malfunction.
UR	Connection malfunction over indoor units or type mismatch (wrong type of indoor units or heat exchanger unit)
UC	Centralised address duplication
UE	Malfunction in communication centralised control device - indoor unit
UF	Auto address malfunction (inconsistency)
UH	Auto address malfunction (inconsistency)



### 14.2 Symptoms that are NOT system malfunctions

The following symptoms are NOT system malfunctions:

#### 14.2.1 Symptom: The system does not operate

- The air conditioner does not start immediately after the ON/OFF button on the user interface is pressed. If the operation lamp lights, the system is in normal condition. To prevent overloading of the compressor motor, the air conditioner starts 5 minutes after it is turned ON again in case it was turned OFF just before. The same starting delay occurs after the operation mode selector button was used.
- If "Under Centralized Control" is displayed on the user interface, pressing the operation button causes the display to blink for a few seconds. The blinking display indicates that the user interface cannot be used.
- The system does not start immediately after the power supply is turned on. Wait one minute until the micro computer is prepared for operation.

#### 14.2.2 Symptom: Cool/Heat cannot be changed over

- When the display shows  (change-over under centralized control), it shows that this is a slave user interface.
- When the cool/heat changeover remote control switch is installed and the display shows  (change-over under centralized control), this is because cool/heat changeover is controlled by the cool/ heat changeover remote control switch. Ask your dealer where the remote control switch is installed.

#### 14.2.3 Symptom: Fan operation is possible, but cooling and heating do not work

Immediately after the power is turned on. The micro computer is getting ready to operate and is performing a communication check with all indoor units. Please wait 12 minutes maximally until this process is finished.

#### 14.2.4 Symptom: The fan strength does not correspond to the setting

The fan speed does not change even if the fan speed adjustment button is pressed. During heating operation, when the room temperature reaches the set temperature, the compressor unit goes off and the indoor unit changes to whisper fan speed. This is to prevent cold air blowing directly on occupants of the room. The fan speed will not change even when another indoor unit is in heating operation, if the button is pressed.

#### 14.2.5 Symptom: The fan direction does not correspond to the setting

The fan direction does not correspond with the user interface display. The fan direction does not swing. This is because the unit is being controlled by the micro computer.

#### 14.2.6 Symptom: White mist comes out of a unit (Indoor unit)

- When humidity is high during cooling operation. If the interior of an indoor unit is extremely contaminated, the temperature distribution inside a room becomes uneven. It is necessary to clean the interior of the indoor unit. Ask your dealer for details on cleaning the unit. This operation requires a qualified service person.

- Immediately after the cooling operation stops and if the room temperature and humidity are low. This is because warm refrigerant gas flows back into the indoor unit and generates steam.

#### 14.2.7 Symptom: White mist comes out of a unit (Indoor unit, heat exchanger unit)

When the system is changed over to heating operation after defrost operation. Moisture generated by defrost becomes steam and is exhausted.

#### 14.2.8 Symptom: The user interface display reads "U4" or "U5" and stops, but then restarts after a few minutes

This is because the user interface is intercepting noise from electric appliances other than the air conditioner. The noise prevents communication between the units, causing them to stop. Operation automatically restarts when the noise ceases.

#### 14.2.9 Symptom: Noise of air conditioners (Indoor unit, heat exchanger unit)

- A "zeen" sound is heard immediately after the power supply is turned on. The electronic expansion valve inside an indoor unit starts working and makes the noise. Its volume will reduce in about one minute.
- A continuous low "shah" sound is heard when the system is in cooling operation or at a stop. When the drain pump (optional accessories) is in operation, this noise is heard.
- A "pishi-pishi" squeaking sound is heard when the system stops after heating operation. Expansion and contraction of plastic parts caused by temperature change make this noise.
- A low "sah", "choro-choro" sound is heard while the indoor unit is stopped. When another indoor unit is in operation, this noise is heard. In order to prevent oil and refrigerant from remaining in the system, a small amount of refrigerant is kept flowing.

#### 14.2.10 Symptom: Noise of air conditioners (Indoor unit, compressor unit, heat exchanger unit)

- A continuous low hissing sound is heard when the system is in cooling or defrost operation. This is the sound of refrigerant gas flowing through the compressor unit, heat exchanger unit and indoor units.
- A hissing sound which is heard at the start or immediately after stopping operation or defrost operation. This is the noise of refrigerant caused by flow stop or flow change.

#### 14.2.11 Symptom: Noise of air conditioners (compressor unit, heat exchanger unit)

When the tone of operating noise changes. This noise is caused by the change of frequency from the compressor or the fans.

#### 14.2.12 Symptom: Dust comes out of the heat exchanger unit

When the unit is used for the first time in a long time. This is because dust has gotten into the heat exchanger unit.

#### 14.2.13 Symptom: The units can give off odours

The unit can absorb the smell of rooms, furniture, cigarettes, etc., and then emit it again.

#### 14.2.14 Symptom: The heat exchanger unit fan does not spin

During operation. The speed of the fan is controlled in order to optimise product operation.

#### 14.2.15 Symptom: The display shows "88"

This is the case immediately after the main power supply switch is turned on and means that the user interface is in normal condition. This continues for 1 minute.

#### 14.2.16 Symptom: The compressor in the compressor unit does not stop after a short heating operation

This is to prevent refrigerant from remaining in the compressor. The unit will stop after 5 to 10 minutes.

#### 14.2.17 Symptom: The inside of an compressor unit is warm even when the unit has stopped

This is because the crankcase heater is warming the compressor so that the compressor can start smoothly.

#### 14.2.18 Symptom: Hot air can be felt when the indoor unit is stopped

Several different indoor units are being run on the same system. When another unit is running, some refrigerant will still flow through the unit.

## 15 Relocation

Contact your dealer for removing and reinstalling the total unit. Moving units requires technical expertise.

## 16 Disposal

This unit uses hydrofluorocarbon. Contact your dealer when discarding this unit.



#### NOTICE

Do not try to dismantle the system yourself: the dismantling of the system, treatment of the refrigerant, oil and other parts must comply with applicable legislation. Units must be treated at a specialised treatment facility for reuse, recycling and recovery.

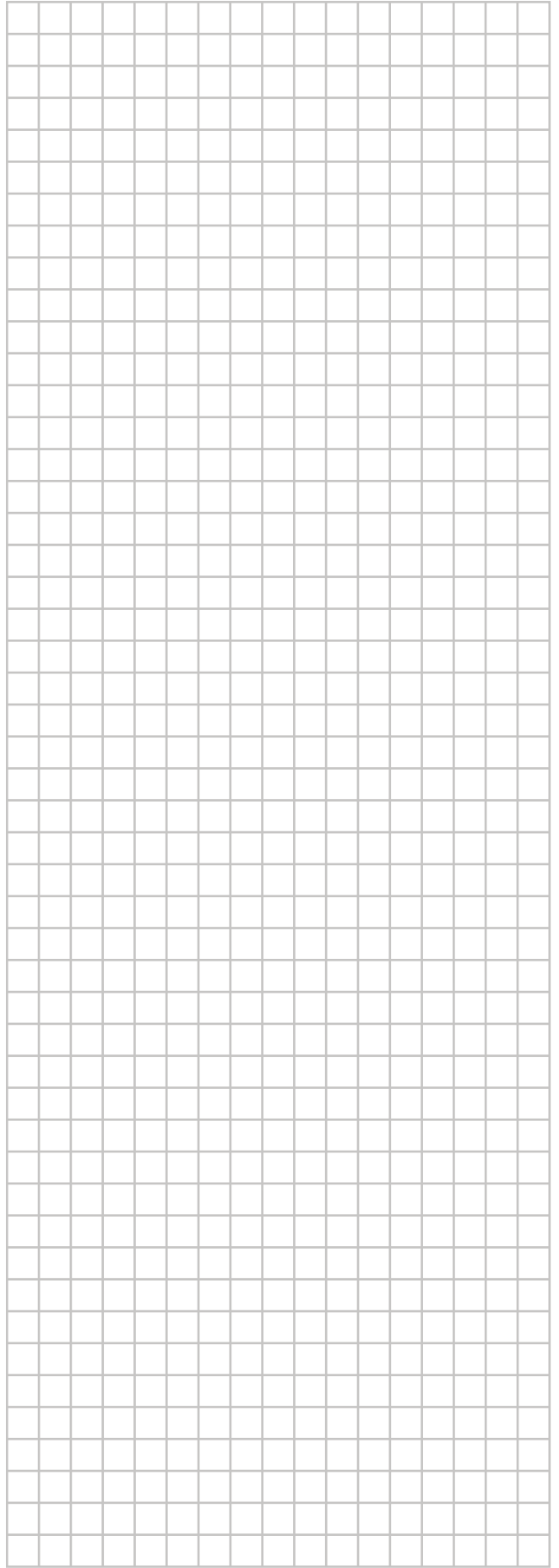
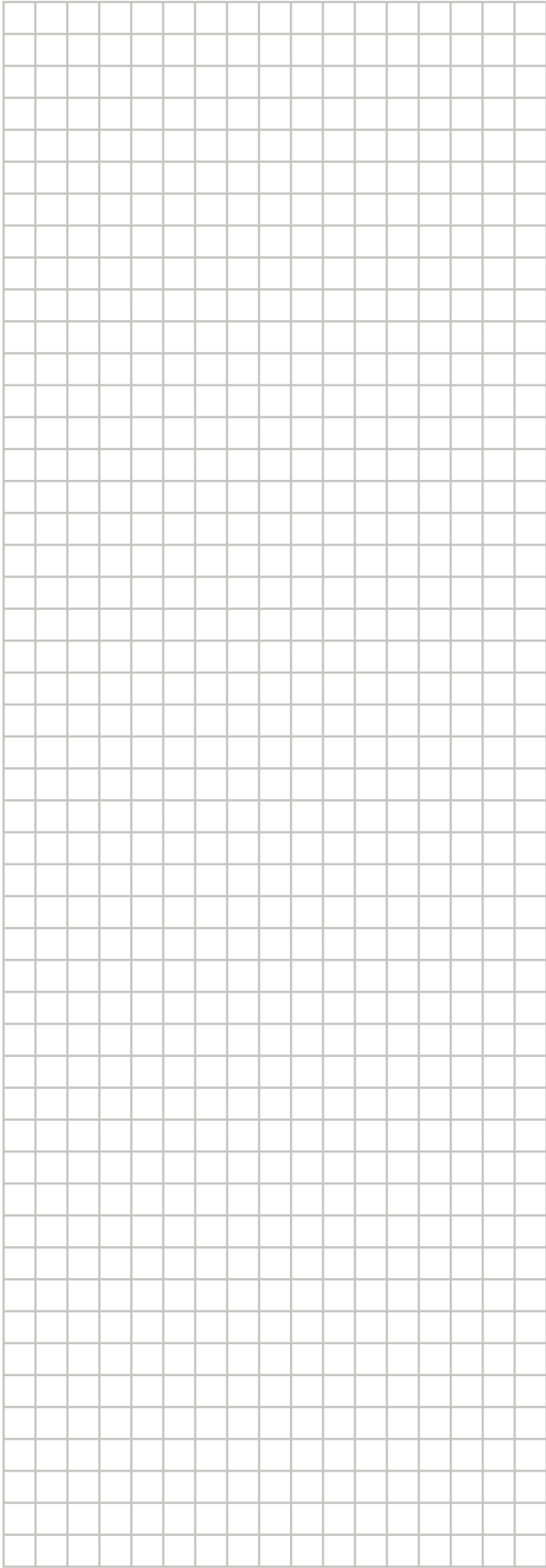

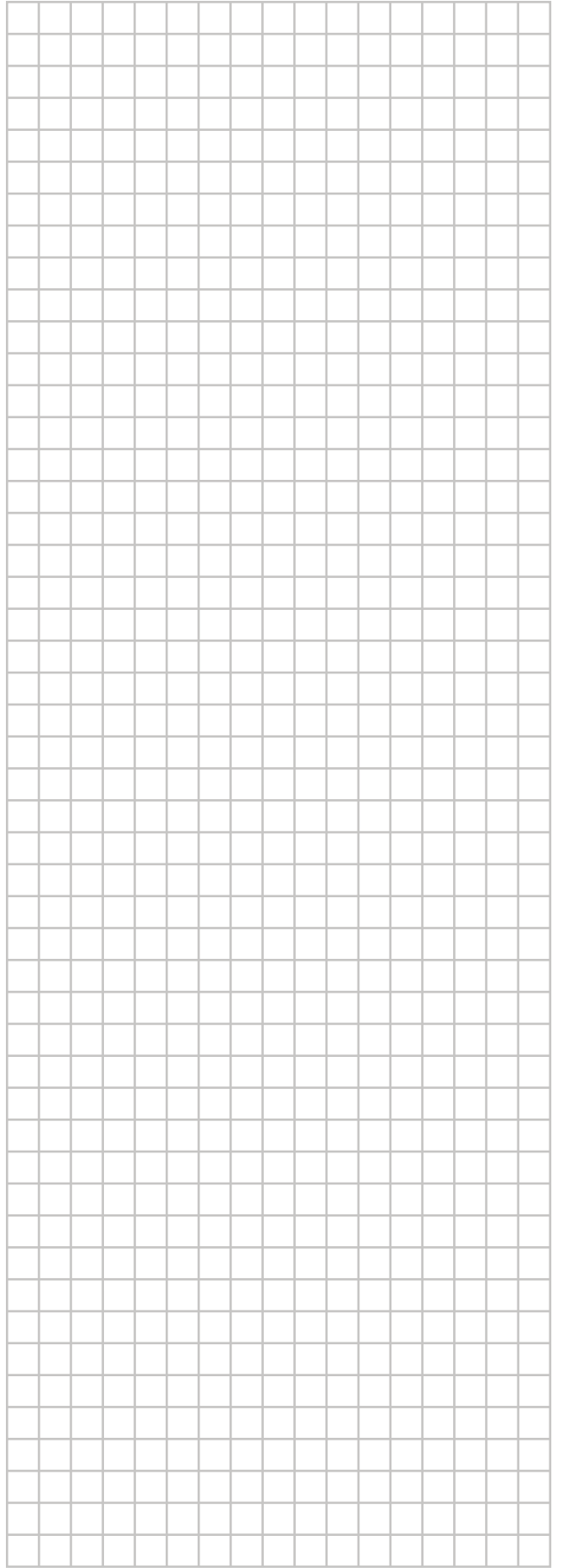
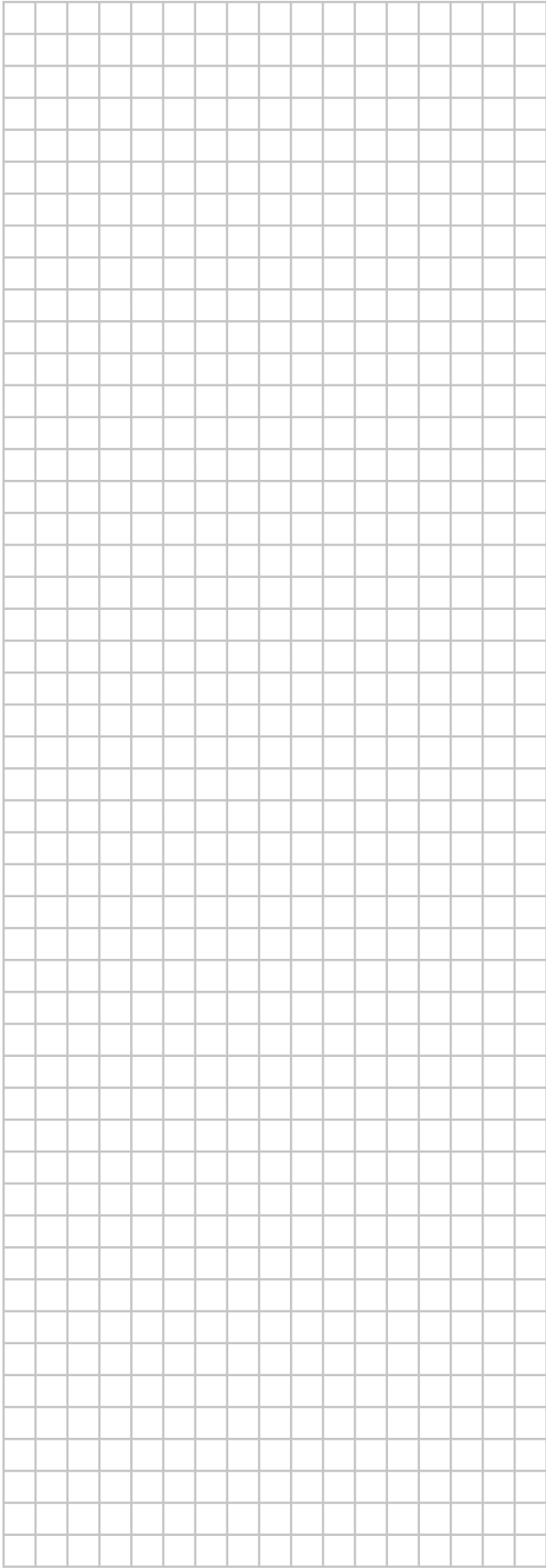



ERC



4P499900-1 0000000T

Copyright 2017 Daikin

**DAIKIN EUROPE N.V.**

Zandvoordestraat 300, B-8400 Oostende, Belgium

4P499900-1 2017.09