

DAIKIN

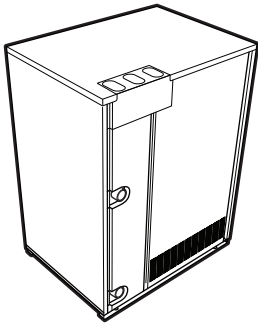

Installation and operation manual

VRV IV water-cooled system air conditioner



**RWEYQ8T9Y1B
RWEYQ10T9Y1B
RWEYQ12T9Y1B
RWEYQ14T9Y1B**

Installation and operation manual
VRV IV water-cooled system air conditioner

English

- CE - DECLARACIONE-DE-CONFORMIDAD
- CE - DICHIARAZIONE-DI-CONFORMITA
- CE - ДИКЛАРАЦИЈА ОД КОНФОРМИТА
- CE - CONFORMITÄTSERKLÄRUNG

Daikin Europe N.V.

- 01 (en) déclare under its sole responsibility that the air conditioning models to which this declaration relates.
- 02 (en) erklärt auf seine alleinige Verantwortung, daß die Modelle der Klimaanlage für die diese Erklärung besichtigt ist.
- 03 (en) déclare sous sa seule responsabilité que les appareils qui font l'objet de la présente déclaration.
- 04 (en) déclare under its own responsibility that the air conditioning units in question have been tested and found to conform with the applicable standards.
- 05 (en) déclare sous sa seule responsabilité que les modèles de air conditioning à sa charge ont été vérifiés et déclarés conformes à la norme applicable.
- 06 (en) déclare sous sa seule responsabilité que les modèles de air conditioning à sa charge ont été vérifiés et déclarés conformes à la norme applicable.
- 07 (en) déclare sous sa seule responsabilité que les modèles de air conditioning à sa charge ont été vérifiés et déclarés conformes à la norme applicable.
- 08 (en) déclare sous sa seule responsabilité que les modèles de air conditioning à sa charge ont été vérifiés et déclarés conformes à la norme applicable.

RWEYQ8T9Y1B*, RWEYQ10T9Y1B*, RWEYQ12T9Y1B*, RWEYQ14T9Y1B*,

* = 1, 2, 3, ..., 9

- 01 are in conformity with the following standard(s) or other normative document(s), provided that these are used in accordance with our instructions:
- 02 deriden følgende Normen) oder einem anderen Normdokument oder einem anderen technischen Zeichnungsverzeichnis mit der folgenden Beschreibung der Modelle der Klimaanlage, unter der Voraussetzung, daß sie mit den in der Beschreibung angegebenen Normen übereinstimmen.
- 03 sont conformes à laux normes) (ou autres) document(s) normatif(s).
- 04 conformi con le norme) (o altri) documenti normativi).
- 05 están en conformidad con el(s) siguiente(s) norma(s) u otro(s) documento(s) normativo(s), siempre que sean utilizados de acuerdo con nuestras instrucciones.
- 06 sono conformi al(i) seguente(i) standard(i) (o altro(i) documento(i)) del presente manuale.
- 07 е у складу са следећих норма(и) и/или докумената(и) стандарта(и).
- 08 e em conformidade com al(s) seguinte(s) norma(s) ou outro(s) documento(s) normativo(s), desde que estas sejam utilizadas de acordo com as nossas instruções.

EN60335-2-40,

- 01 follows the provisions of:
- 02 emite conformance with the following provisions:
- 03 conformant aux stipulations des:
- 04 overeenkomstig de bepalingen van:
- 05 conforme às disposições de:
- 06 secondo le prescrizioni per:
- 07 je u skladu sa odredbama iz:
- 08 e conformi con le disposizioni di:
- 09 в соответствии с положениями:
- 10 underligger de af bestemmelserne i:
- 11 enligt villkoren i:
- 12 ogfti henhold til bestemmelserne i:
- 13 noudatiin määrättyjä:
- 14 za državnih ustanovljenih predpisov:
- 15 prema odredbama:
- 16 kuveiti agi:
- 17 je u skladu sa odredbama iz:
- 18 в соответствии с положениями:

- 01 as set out in the Technical Construction File >> and judged positively by >> according to the Certificate >>
- 02 as set out in the Technical Construction File >> and judged positively by >> according to the Certificate >>
- 03 as set out in the Technical Construction File >> and judged positively by >> according to the Certificate >>
- 04 as set out in the Technical Construction File >> and judged positively by >> according to the Certificate >>
- 05 as set out in the Technical Construction File >> and judged positively by >> according to the Certificate >>
- 06 as set out in the Technical Construction File >> and judged positively by >> according to the Certificate >>
- 07 as set out in the Technical Construction File >> and judged positively by >> according to the Certificate >>
- 08 as set out in the Technical Construction File >> and judged positively by >> according to the Certificate >>
- 09 as set out in the Technical Construction File >> and judged positively by >> according to the Certificate >>

- CE - DECLARACIONE-DE-CONFORMIDAE
- CE - DICHIARAZIONE-DI-CONFORMITA
- CE - ДИКЛАРАЦИЈА ОД КОНФОРМИТА
- CE - CONFORMITÄTSERKLÄRUNG

- 08 (en) завяла, исполнителя под свое ответственность, что модели кондиционеров воздуха, к которым относится настоящее заявление:
- 09 (en) erklærer under ansvar at klimaapparaterne i denne erklæring er i overensstemmelse med følgende standard(er) eller andet/andre dokument(er) (herunder tekniske tegninger), forudsat at disse bruges i henhold til de angivne instruktioner.
- 10 (en) déclare sous sa seule responsabilité que les modèles de air conditioning à sa charge ont été vérifiés et déclarés conformes à la norme applicable.
- 11 (en) déclare sous sa seule responsabilité que les modèles de air conditioning à sa charge ont été vérifiés et déclarés conformes à la norme applicable.
- 12 (en) déclare sous sa seule responsabilité que les modèles de air conditioning à sa charge ont été vérifiés et déclarés conformes à la norme applicable.
- 13 (en) déclare sous sa seule responsabilité que les modèles de air conditioning à sa charge ont été vérifiés et déclarés conformes à la norme applicable.
- 14 (en) déclare sous sa seule responsabilité que les modèles de air conditioning à sa charge ont été vérifiés et déclarés conformes à la norme applicable.
- 15 (en) déclare sous sa seule responsabilité que les modèles de air conditioning à sa charge ont été vérifiés et déclarés conformes à la norme applicable.
- 16 (en) déclare sous sa seule responsabilité que les modèles de air conditioning à sa charge ont été vérifiés et déclarés conformes à la norme applicable.

- CE - IZJAVA O SKLADNOSTI
- CE - VASTAVISUKĀRTIŠOONS
- CE - DEKLARACIJA O SOGLEDNOSTI
- CE - DECLARAȚIE DE CONFORMITATE

- 17 (en) declare under its sole responsibility that the air conditioning models to which this declaration relates.
- 18 (en) erklärt auf seine alleinige Verantwortung, daß die Modelle der Klimaanlage für die diese Erklärung besichtigt ist.
- 19 (en) déclare sous sa seule responsabilité que les appareils qui font l'objet de la présente déclaration.
- 20 (en) déclare under its own responsibility that the air conditioning units in question have been tested and found to conform with the applicable standards.
- 21 (en) déclare sous sa seule responsabilité que les modèles de air conditioning à sa charge ont été vérifiés et déclarés conformes à la norme applicable.
- 22 (en) déclare sous sa seule responsabilité que les modèles de air conditioning à sa charge ont été vérifiés et déclarés conformes à la norme applicable.
- 23 (en) déclare sous sa seule responsabilité que les modèles de air conditioning à sa charge ont été vérifiés et déclarés conformes à la norme applicable.
- 24 (en) déclare sous sa seule responsabilité que les modèles de air conditioning à sa charge ont été vérifiés et déclarés conformes à la norme applicable.
- 25 (en) déclare sous sa seule responsabilité que les modèles de air conditioning à sa charge ont été vérifiés et déclarés conformes à la norme applicable.

- CE - ATTIKTES-DEKLARACIJA
- CE - ATBILSTĀTES-DEKLARĀCIJA
- CE - VYLASENE ZHODY
- CE - UYGUNLILIK BEYANI

- 21 (en) déclare sous sa seule responsabilité que les modèles de air conditioning à sa charge ont été vérifiés et déclarés conformes à la norme applicable.
- 22 (en) déclare sous sa seule responsabilité que les modèles de air conditioning à sa charge ont été vérifiés et déclarés conformes à la norme applicable.
- 23 (en) déclare sous sa seule responsabilité que les modèles de air conditioning à sa charge ont été vérifiés et déclarés conformes à la norme applicable.
- 24 (en) déclare sous sa seule responsabilité que les modèles de air conditioning à sa charge ont été vérifiés et déclarés conformes à la norme applicable.
- 25 (en) déclare sous sa seule responsabilité que les modèles de air conditioning à sa charge ont été vérifiés et déclarés conformes à la norme applicable.

Machinery 2006/42/EC

- 01 Directives as amended.
- 02 Direktiven, med senere ændringer.
- 03 Richtlinien, mit späteren Änderungen.
- 04 Richtlijnen, zoals gewijzigd.
- 05 Directives, según se emendado.
- 06 Direktive, sonega da modifika.
- 07 Одрбли, онсуз згову ипропоубел.
- 08 Direktivas, condome alterado em.
- 09 Директива, condome ипоправана.
- 10 Direktiver, med senere ændringer.
- 11 Direktiv, med senere ændringer.
- 12 Direktive, med senere ændringer.
- 13 Direktives, telles que modifiées.
- 14 Richtlijnen, zoals gewijzigd.
- 15 Directives, según se emendado.
- 16 Direktive, sonega da modifika.
- 17 Одрбли, онсуз згову ипропоубел.
- 18 Direktivas, condome ипоправана.
- 19 Direktywy, z późniejszymi poprawkami.
- 20 Direktiwa, sonega da modifika.
- 21 Direktiwa, sonega da modifika.
- 22 Direktiwa, sonega da modifika.
- 23 Direktiwa, sonega da modifika.
- 24 Direktiwa, sonega da modifika.
- 25 Direktiwa, sonega da modifika.

Electromagnetic Compatibility 2014/30/EU

- 01 Directives as amended.
- 02 Direktiven, med senere ændringer.
- 03 Richtlinien, mit späteren Änderungen.
- 04 Richtlijnen, zoals gewijzigd.
- 05 Directives, según se emendado.
- 06 Direktive, sonega da modifika.
- 07 Одрбли, онсуз згову ипропоубел.
- 08 Direktivas, condome ипоправана.
- 09 Директива, condome ипоправана.
- 10 Direktiver, med senere ændringer.
- 11 Direktiv, med senere ændringer.
- 12 Direktive, med senere ændringer.
- 13 Direktives, telles que modifiées.
- 14 Richtlijnen, zoals gewijzigd.
- 15 Directives, según se emendado.
- 16 Direktive, sonega da modifika.
- 17 Одрбли, онсуз згову ипропоубел.
- 18 Direktivas, condome ипоправана.
- 19 Direktywy, z późniejszymi poprawkami.
- 20 Direktiwa, sonega da modifika.
- 21 Direktiwa, sonega da modifika.
- 22 Direktiwa, sonega da modifika.
- 23 Direktiwa, sonega da modifika.
- 24 Direktiwa, sonega da modifika.
- 25 Direktiwa, sonega da modifika.

Pressure Equipment 2014/68/EU

- 01 Directives as amended.
- 02 Direktiven, med senere ændringer.
- 03 Richtlinien, mit späteren Änderungen.
- 04 Richtlijnen, zoals gewijzigd.
- 05 Directives, según se emendado.
- 06 Direktive, sonega da modifika.
- 07 Одрбли, онсуз згову ипропоубел.
- 08 Direktivas, condome ипоправана.
- 09 Директива, condome ипоправана.
- 10 Direktiver, med senere ændringer.
- 11 Direktiv, med senere ændringer.
- 12 Direktive, med senere ændringer.
- 13 Direktives, telles que modifiées.
- 14 Richtlijnen, zoals gewijzigd.
- 15 Directives, según se emendado.
- 16 Direktive, sonega da modifika.
- 17 Одрбли, онсуз згову ипропоубел.
- 18 Direktivas, condome ипоправана.
- 19 Direktywy, z późniejszymi poprawkami.
- 20 Direktiwa, sonega da modifika.
- 21 Direktiwa, sonega da modifika.
- 22 Direktiwa, sonega da modifika.
- 23 Direktiwa, sonega da modifika.
- 24 Direktiwa, sonega da modifika.
- 25 Direktiwa, sonega da modifika.

Low Voltage Directive 2011/65/EU

- 01 Directives as amended.
- 02 Direktiven, med senere ændringer.
- 03 Richtlinien, mit späteren Änderungen.
- 04 Richtlijnen, zoals gewijzigd.
- 05 Directives, según se emendado.
- 06 Direktive, sonega da modifika.
- 07 Одрбли, онсуз згову ипропоубел.
- 08 Direktivas, condome ипоправана.
- 09 Директива, condome ипоправана.
- 10 Direktiver, med senere ændringer.
- 11 Direktiv, med senere ændringer.
- 12 Direktive, med senere ændringer.
- 13 Direktives, telles que modifiées.
- 14 Richtlijnen, zoals gewijzigd.
- 15 Directives, según se emendado.
- 16 Direktive, sonega da modifika.
- 17 Одрбли, онсуз згову ипропоубел.
- 18 Direktivas, condome ипоправана.
- 19 Direktywy, z późniejszymi poprawkami.
- 20 Direktiwa, sonega da modifika.
- 21 Direktiwa, sonega da modifika.
- 22 Direktiwa, sonega da modifika.
- 23 Direktiwa, sonega da modifika.
- 24 Direktiwa, sonega da modifika.
- 25 Direktiwa, sonega da modifika.

13** Dakin Europe N.V. en autoriza a completar el formulario de conformidad técnica de fabricación.

14** Společnost Dakin Europe N.V. má oprávnění ke kompletnímu technickému konceptu.

15** Dakin Europe N.V. es autorizada a completar el formulario de conformidad técnica de fabricación.

16** Dakin Europe N.V. is autorisiert zu den technischen Zeichnungen der technischen Konzeption.

17** Dakin Europe N.V. is authorized to complete the technical construction file.

18** Dakin Europe N.V. har tillatelse til å komplettere den tekniske konstruksjonsfilen.

<A>	DAIKIN.TCF.030A.25111-2016
	TUV (NB1856)
<C>	12080901.1.T30
<D>	Daikin.TCFP.001
<E>	VINCOTTE nv (NB0026)
<F>	D1
<G>	—
<H>	11

Table of contents

Table of contents

1	About the documentation	5
1.1	About this document.....	5
For the installer		5
2	About the box	5
2.1	To remove the accessories from the outdoor unit	5
2.2	Accessory pipes: Diameters.....	5
2.3	To remove the transportation stay.....	6
3	About the units and options	6
3.1	About the outdoor unit.....	6
3.2	System layout.....	7
4	Preparation	7
4.1	Preparing installation site	7
4.1.1	Installation site requirements of the outdoor unit	7
4.2	Preparing refrigerant piping.....	7
4.2.1	Refrigerant piping requirements.....	7
4.2.2	To select the piping size	8
4.2.3	To select refrigerant branch kits.....	9
4.2.4	Multiple outdoor units: Possible layouts.....	10
4.3	Preparing water piping	10
4.3.1	Water circuit requirements	10
4.3.2	Handling the brazed plate heat exchanger	11
4.3.3	About the water flow rate	11
4.4	Preparing electrical wiring	12
4.4.1	Safety device requirements	12
5	Installation	13
5.1	Opening the units	13
5.1.1	To open the outdoor unit.....	13
5.1.2	To open the electrical component box of the outdoor unit	13
5.2	Mounting the outdoor unit.....	13
5.2.1	To provide the installation structure	13
5.3	Connecting the refrigerant piping	13
5.3.1	To route the refrigerant piping.....	13
5.3.2	To connect the refrigerant piping to the outdoor unit ..	14
5.3.3	To connect the multi connection piping kit	14
5.3.4	To connect the refrigerant branching kit	14
5.3.5	To protect against contamination.....	14
5.3.6	Using the stop valve and service port.....	14
5.3.7	To remove the pinched pipes.....	15
5.4	Checking the refrigerant piping	16
5.4.1	About checking the refrigerant piping	16
5.4.2	Checking refrigerant piping: General guidelines	16
5.4.3	Checking refrigerant piping: Setup.....	16
5.4.4	To perform a leak test.....	17
5.4.5	To perform vacuum drying	17
5.5	To insulate the refrigerant piping.....	17
5.6	Charging refrigerant	17
5.6.1	Precautions when charging refrigerant	17
5.6.2	About charging refrigerant	18
5.6.3	To determine the additional refrigerant amount.....	18
5.6.4	To charge refrigerant	18
5.6.5	Checks after charging refrigerant.....	19
5.6.6	To fix the fluorinated greenhouse gases label	19
5.7	Connecting the water piping	20
5.7.1	About connecting the water piping	20
5.7.2	To connect the water piping.....	20
5.7.3	To fill the water circuit	20
5.7.4	To insulate the water piping	20
5.8	Connecting the electrical wiring.....	20
5.8.1	Field wiring: Overview.....	20

5.8.2	To route and fix the transmission wiring	20
5.8.3	To connect the transmission wiring.....	21
5.8.4	To finish the transmission wiring.....	21
5.8.5	To route and fix the power supply	21
5.8.6	To connect the power supply	22
5.8.7	To connect the optional wiring	22

6 Configuration **23**

6.1	Making field settings.....	23
6.1.1	About making field settings	23
6.1.2	Field setting components	23
6.1.3	To access the field setting components.....	24
6.1.4	To access mode 1 or 2	24
6.1.5	To use mode 1	24
6.1.6	To use mode 2	24
6.1.7	Mode 1: Monitoring settings.....	25
6.1.8	Mode 2: Field settings.....	25
6.1.9	To connect the PC configurator to the outdoor unit	26

7 Commissioning **26**

7.1	Precautions when commissioning	26
7.2	Checklist before commissioning.....	26
7.3	About test run	27
7.4	To perform a test run.....	27
7.5	Correcting after abnormal completion of the test run	28

8 Troubleshooting **28**

8.1	Solving problems based on error codes.....	28
-----	--	----

9 Technical data **28**

9.1	Service space: Outdoor unit	28
9.2	Piping diagram: Outdoor unit.....	29

For the user **30**

10 About the system **30**

10.1	System layout.....	30
------	--------------------	----

11 User interface **30**

12 Operation **31**

12.1	Operation range	31
12.2	Operating the system	31
12.2.1	About operating the system	31
12.2.2	About cooling, heating, fan only, and automatic operation	31
12.2.3	About the heating operation.....	31
12.2.4	To operate the system (WITHOUT cool/heat changeover remote control switch).....	31
12.2.5	To operate the system (WITH cool/heat changeover remote control switch).....	31
12.3	Using the dry program	32
12.3.1	About the dry program	32
12.3.2	To use the dry program (WITHOUT cool/heat changeover remote control switch).....	32
12.3.3	To use the dry program (WITH cool/heat changeover remote control switch).....	32
12.4	Adjusting the air flow direction.....	32
12.4.1	About the air flow flap	32
12.5	Setting the master user interface	32
12.5.1	About setting the master user interface	32

13 Maintenance and service **32**

13.1	About the refrigerant.....	33
13.2	After-sales service and warranty	33
13.2.1	Warranty period	33
13.2.2	Recommended maintenance and inspection.....	33

14 Troubleshooting **33**

14.1	Error codes: Overview	34
14.2	Symptoms that are NOT system malfunctions	34

14.2.1 Symptom: The system does not operate 34
 14.2.2 Symptom: Cool/Heat cannot be changed over 34
 14.2.3 Symptom: Fan operation is possible, but cooling and heating do not work..... 34
 14.2.4 Symptom: The fan strength does not correspond to the setting 34
 14.2.5 Symptom: The fan direction does not correspond to the setting 34
 14.2.6 Symptom: White mist comes out of a unit (Indoor unit)..... 34
 14.2.7 Symptom: White mist comes out of a unit (Indoor unit, outdoor unit) 34
 14.2.8 Symptom: The user interface display reads "U4" or "U5" and stops, but then restarts after a few minutes. 34
 14.2.9 Symptom: Noise of air conditioners (Indoor unit)..... 34
 14.2.10 Symptom: Noise of air conditioners (Indoor unit, outdoor unit)..... 35
 14.2.11 Symptom: Noise of air conditioners (Outdoor unit)..... 35
 14.2.12 Symptom: Dust comes out of the unit..... 35
 14.2.13 Symptom: The units can give off odours..... 35
 14.2.14 Symptom: The outdoor unit fan does not spin 35
 14.2.15 Symptom: The display shows "88"..... 35
 14.2.16 Symptom: The compressor in the outdoor unit does not stop after a short heating operation 35
 14.2.17 Symptom: The inside of an outdoor unit is warm even when the unit has stopped 35
 14.2.18 Symptom: Hot air can be felt when the indoor unit is stopped 35

15 Relocation **35**
16 Disposal **35**
17 Glossary **35**

1 About the documentation

1.1 About this document

Target audience

Authorised installers + end users

Documentation set

This document is part of a documentation set. The complete set consists of:

- **General safety precautions:**
 - Safety instructions that you must read before installing
 - Format: Paper (in the box of the outdoor unit)
- **Outdoor unit installation and operation manual:**
 - Installation and operation instructions
 - Format: Paper (in the box of the outdoor unit)
- **Installer and user reference guide:**
 - Preparation of the installation, reference data,...
 - Detailed step-by-step instructions and background information for basic and advanced usage
 - Format: Digital files on <http://www.daikineurope.com/support-and-manuals/product-information/>

Latest revisions of the supplied documentation may be available on the regional Daikin website or via your dealer.

The original documentation is written in English. All other languages are translations.

Technical engineering data

- A **subset** of the latest technical data is available on the regional Daikin website (publicly accessible).
- The **full set** of latest technical data is available on the Daikin extranet (authentication required).

For the installer

2 About the box

2.1 To remove the accessories from the outdoor unit

Make sure that all accessories are available in the unit.

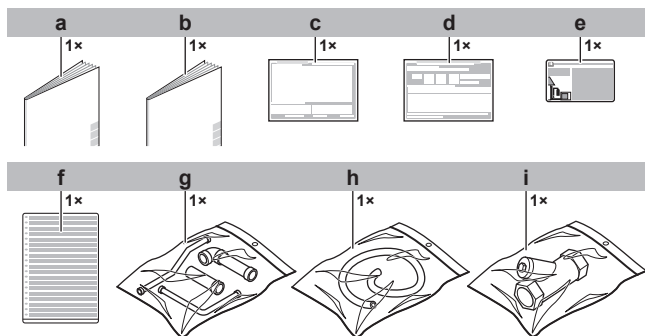



- a General safety precautions
- b Installation manual and operation manual
- c Additional refrigerant charge label
- d Installation information sticker
- e Fluorinated greenhouse gases label

- f Multilingual fluorinated greenhouse gases label
- g Piping accessory bag
- h Hose
- i Water filter

2.2 Accessory pipes: Diameters

Accessory pipes (mm)	HP	Øa	Øb	Øc	Ød
Liquid pipe ▪ Front connection ^(a)	8	12.7	12.7	12.7	9.5
	10				
	12				12.7
14	Top connection	Øc	Ød		

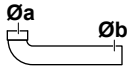
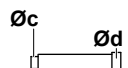
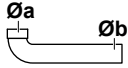
3 About the units and options

Accessory pipes (mm)	HP	Øa	Øb	Øc	Ød
Gas pipe ▪ Front connection ^(a)  ▪ Top connection 	8	25.4	25.4	25.4	19.1
	10				22.2
	12				28.6
	14				
	High pressure/Low pressure gas pipe ▪ Front connection ^(a)  ▪ Top connection 				8
10		19.1			
12		22.2			
14					

(a) Braze the straight accessory pipe onto the L-shaped accessory pipe in order to get the correct diameter to connect the field pipes (for front connection).

2.3 To remove the transportation stay

NOTICE

If the unit is operated with the transportation stay attached, abnormal vibration or noise may be generated.

The compressor transportation stay must be removed. It is installed under the compressor leg in order to protect the unit during transport. Proceed as shown in the figure and procedure below.

- 1 Remove the bolt.
- 2 Lift the insulation to access the compressor mounting bolt.
- 3 Slightly loosen the mounting bolt.
- 4 Remove the transportation stay as shown in the figure below.
- 5 Tighten the mounting bolt to 12.3 N·m of torque.

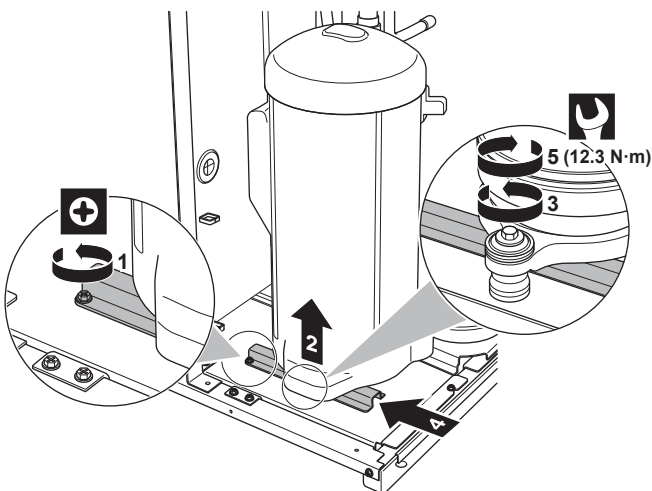

3 About the units and options

3.1 About the outdoor unit

This installation manual concerns the VRV IV water-cooled system air conditioner. The unit is full inverter driven, and can be used for cooling, heat pump and heat recovery applications.

Model line up:

Model	Description
RWEYQ8~14	Heat recovery model for single or multi-use

Depending on the chosen type of unit, some functionality will or will not exist. It will be indicated throughout this installation manual and brought to your attention. Certain features have exclusive model rights.

These units are intended for indoor installation and aimed for heat pump applications including water to air and water to water applications.

These units have (in single use) heating capacities ranging from 25 to 45 kW and cooling capacities ranging from 22.4 to 40 kW. When multi combination is used, the capacity can go up to 135 kW for heating and 120 kW for cooling.

The unit is designed to work in heating mode at indoor temperatures from 15°C WB to 27°C WB and in cooling mode at indoor temperatures from 21°C DB to 32°C DB or 14°C WB to 25°C WB.

The ambient temperature around the unit should be above 0°C DB and below 40°C DB. Relative humidity around the unit should be below 80%.

The water temperature at the water inlet of the unit must be between 10°C and 45°C. The lower limit is extendable down to -10°C (heating operation mode) in case the brine type setting [2-50] is set for use with brine as heat source medium.

3.2 System layout

Heat recovery system

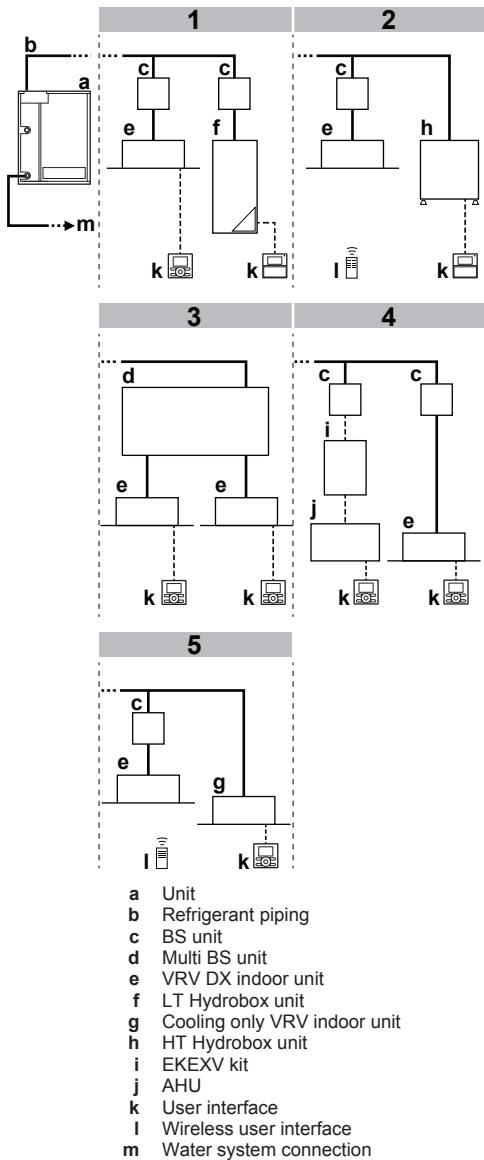

Heat pump system

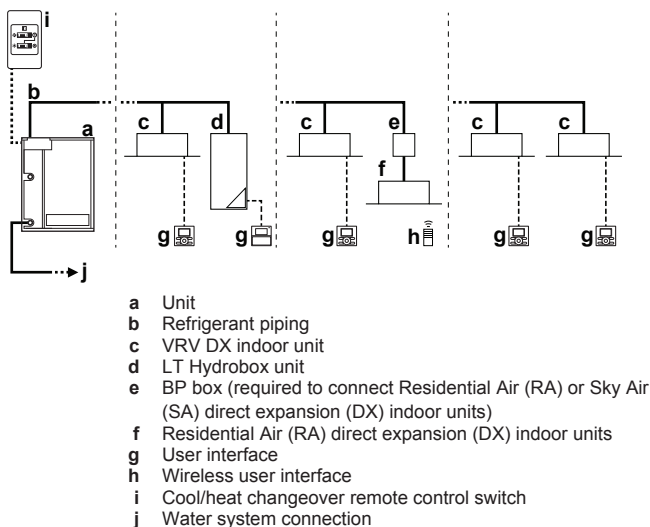

Water system

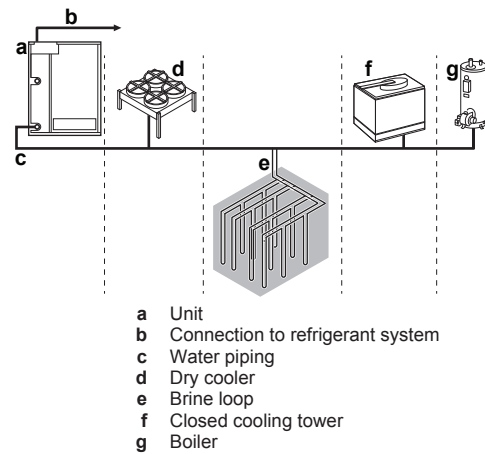

4 Preparation

4.1 Preparing installation site

4.1.1 Installation site requirements of the outdoor unit

Mind the spacing guidelines. See the "Technical data" chapter.



CAUTION

Appliance not accessible to the general public, install it in a secured area, protected from easy access.

This unit, both indoor and outdoor, is suitable for installation in a commercial and light industrial environment.



NOTICE

This equipment is compliant with Class A of EN55032/ CISPR 32. In a residential environment this equipment may cause radio interference.

4.2 Preparing refrigerant piping

4.2.1 Refrigerant piping requirements



NOTICE

Refrigerant R410A requires strict cautions for keeping the system clean and dry. Foreign materials (including mineral oils or moisture) should be prevented from getting mixed into the system.



NOTICE

The piping and other pressure-containing parts shall be suitable for refrigerant. Use phosphoric acid deoxidised seamless copper for refrigerant.

- Foreign materials inside pipes (including oils for fabrication) must be ≤ 30 mg/10 m.
- Temper grade: use piping with temper grade in function of the pipe diameter as listed in table below.

Pipe Ø	Temper grade of piping material
≤ 15.9 mm	O (annealed)
≥ 19.1 mm	1/2H (half hard)

4 Preparation

- All piping lengths and distances have been taken into consideration (see About the piping length in the installer reference guide).
- The pipe thickness of the refrigerant piping shall comply with the applicable legislation. The minimal pipe thickness for R410A piping must be in accordance with the table below.

Pipe Ø	Minimal thickness t
6.4 mm/9.5 mm/12.7 mm	0.80 mm
15.9 mm	0.99 mm
19.1 mm/22.2 mm	0.80 mm
28.6 mm	0.99 mm
34.9 mm	1.21 mm
41.3 mm	1.43 mm

- In case the required pipe sizes (inch sizes) are not available, it is also allowed to use other diameters (mm sizes), taken the following into account:
 - Select the pipe size nearest to the required size.
 - Use the suitable adapters for the change-over from inch to mm pipes (field supply).
 - The additional refrigerant calculation has to be adjusted as mentioned in "5.6.3 To determine the additional refrigerant amount" on page 18.

4.2.2 To select the piping size



INFORMATION

Please select the proper pipe sizes depending on the mode of your system. There are 2 possible modes:

- heat pump,
- heat recovery.

Determine the proper size using the following tables and reference figure (only for indication).

In case of heat pump mode

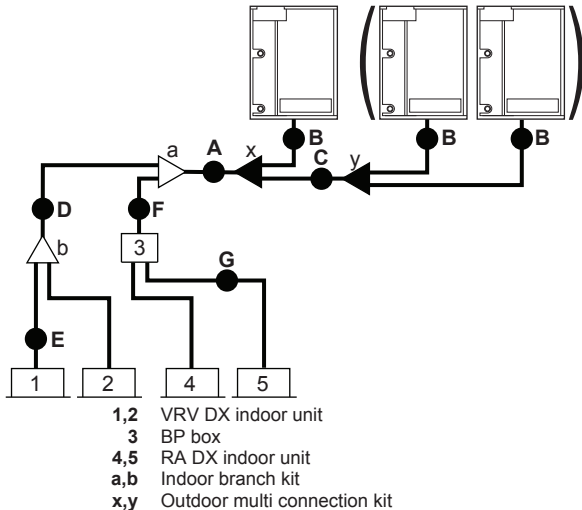

In case of heat recovery mode

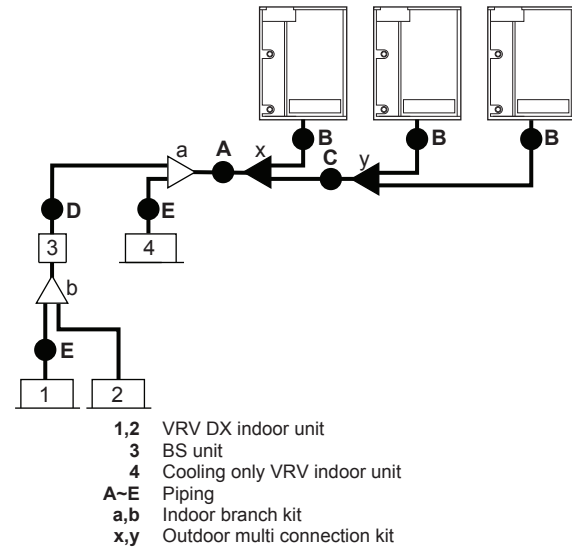

A, B, C: Piping between outdoor unit and (first) refrigerant branch kit

Choose from the following table in accordance with the outdoor unit total capacity type, connected downstream.

In case of heat pump mode

Outdoor unit capacity type (HP)	Piping outer diameter size (mm)	
	Gas pipe	Liquid pipe
8	19.1	9.5
10	22.2	
12~16	28.6	12.7
18~22		15.9
24	34.9	19.1
26~34		
36~42	41.3	

In case of heat recovery mode

Outdoor unit capacity type (HP)	Piping outer diameter size (mm)		
	Liquid pipe	Suction gas pipe	High pressure/low pressure gas pipe
5~8	9.5	19.1	15.9
10		22.2	19.1
12	12.7	28.6	22.2
14~16			
18	15.9	34.9	28.6
20~22			
24	19.1	41.3	34.9
26~34			
36			
38~42			

D: Piping between refrigerant branch kits or refrigerant branch kit and BS unit

Choose from the following table in accordance with the indoor unit total capacity type, connected downstream. Do not let the connection piping exceed the refrigerant piping size chosen by the general system model name.

In case of heat pump mode

Indoor unit capacity index	Piping outer diameter size (mm)	
	Gas pipe	Liquid pipe
<150	15.9	9.5
150≤x<200	19.1	
200≤x<290	22.2	
290≤x<420	28.6	12.7
420≤x<640		15.9
640≤x<920	34.9	19.1
≥920	41.3	

In case of heat recovery mode

Indoor unit capacity index	Piping outer diameter size (mm)		
	Liquid pipe	Suction gas pipe	High pressure/low pressure gas pipe
<150	9.5	15.9	12.7
150≤x<200		19.1	15.9
200≤x<290		22.2	19.1
290≤x<420	12.7	28.6	28.6
420≤x<640	15.9		
640≤x<920	19.1	34.9	
≥920		41.3	

Example:

- Downstream capacity for E=[capacity index of unit 1]
- Downstream capacity for D=[capacity index of unit 1]+[capacity index of unit 2]

E: Piping between refrigerant branch kit or BS unit and indoor unit

For heat pump mode and heat recovery mode

Pipe size for direct connection to indoor unit must be the same as the connection size of the indoor unit.

Indoor unit capacity index	Piping outer diameter size (mm)	
	Gas pipe	Liquid pipe
15~50	12.7	6.4
63~140	15.9	9.5
200	19.1	
250	22.2	

- If a size-up of the piping is required, refer to the table below.

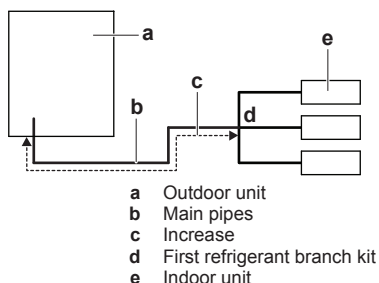

Size up	
HP class	Liquid piping outer diameter size (mm)
5~8	9.5 → 12.7
10	
12+14	12.7 → 15.9
16	

Size up	
HP class	Liquid piping outer diameter size (mm)
18~22	15.9 → 19.1
24	
26~34	19.1 → 22.2
36~42	

F: Piping between refrigerant branch kit and BP unit

Heat pump mode in case of single outdoor unit

Pipe size for direct connection on BP unit must be based on the total capacity of the connected indoor units (only in case RA DX indoor units are connected).

Total capacity index of connected indoor units	Piping outer diameter size (mm)	
	Gas pipe	Liquid pipe
20~62	12.7	6.4
63~149	15.9	9.5
150~208	19.1	

Example:

Downstream capacity for F=[capacity index of unit 4]+[capacity index of unit 5]

G: Piping between BP unit and RA DX indoor unit

Heat pump mode in case of single outdoor unit

Only in case RA DX indoor units are connected.

Indoor unit capacity index	Piping outer diameter size (mm)	
	Gas pipe	Liquid pipe
20, 25, 30	9.5	6.4
50		
60	12.7	9.5
71		
	15.9	

4.2.3 To select refrigerant branch kits

Refrigerant refnets

For piping example, refer to "4.2.2 To select the piping size" on page 8.

- When using refnet joints at the first branch counted from the outdoor unit side, choose from the following table in accordance with the capacity of the outdoor unit (example: refnet joint a).

Outdoor unit capacity type (HP)	2 pipes	3 pipes
8~10	KHRQ22M29T9	KHRQ23M29T9
12~22	KHRQ22M64T	KHRQ23M64T
24~42	KHRQ22M75T	KHRQ23M75T

- For refnet joints other than the first branch (example refnet joint b), select the proper branch kit model based on the total capacity index of all indoor units connected after the refrigerant branch.

Indoor unit capacity index	2 pipes	3 pipes
<200	KHRQ22M20T	KHRQ23M20T
200≤x<290	KHRQ22M29T9	KHRQ23M29T9
290≤x<640	KHRQ22M64T	KHRQ23M64T
≥640	KHRQ22M75T	KHRQ23M75T

4 Preparation

- Concerning refnet headers, choose from the following table in accordance with the total capacity of all the indoor units connected below the refnet header.

Indoor unit capacity index	2 pipes	3 pipes
<200	KHRQ22M29H	KHRQ23M29H
200≤x<290		
290≤x<640	KHRQ22M64H ^(a)	KHRQ23M64H ^(a)
≥640	KHRQ22M75H	KHRQ23M75H

(a) If the pipe size above the refnet header is Ø34.9 mm or more, KHRQ22M75H is required.

INFORMATION

Maximum 8 branches can be connected to a header.

- How to choose an outdoor multi connection piping kit. Choose from the following table in accordance with the number of outdoor units.

Number of outdoor units	Branch kit name
2	BHFQ22P1007
3	BHFQ22P1517

INFORMATION

Reducers or T-joints are field supplied.

NOTICE

Refrigerant branch kits can only be used with R410A.

4.2.4 Multiple outdoor units: Possible layouts

- The piping between the outdoor units must be routed level or slightly upward to avoid the risk of oil retention into the piping.

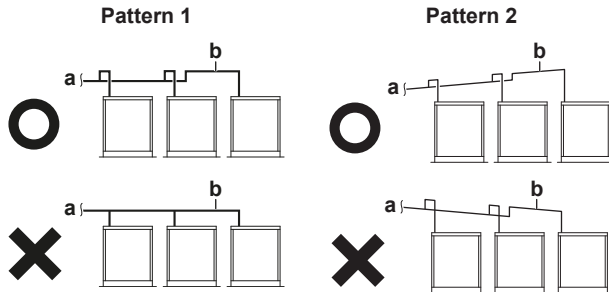

- a To indoor unit
- b Piping between outdoor units
- X Not allowed (oil remains in piping)
- O Allowed

- If the piping length between the outdoor unit connecting pipe kit or between the outdoor units exceeds 2 m, create a rise of 200 mm or more in the gas line within a length of 2 m from the kit.
- For the gas piping (both discharge and suction gas piping in case of the heat recovery system) after the branch, install a trap of 200 mm or more using the piping included in the piping kit for connecting the outdoor unit. Otherwise, the refrigerant may stay in the piping, causing damage to the outdoor unit.

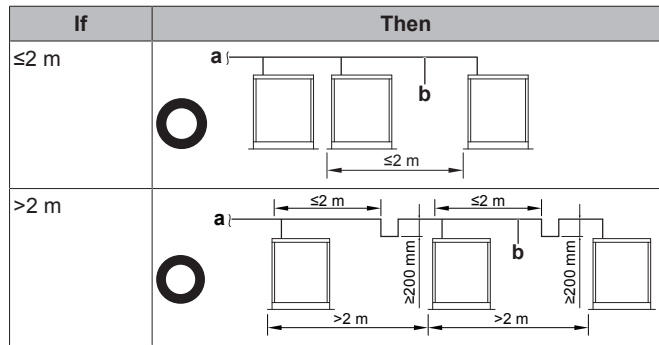
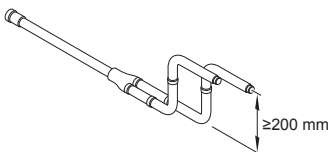

- a To indoor unit
- b Piping between outdoor units

NOTICE

There are restrictions on the refrigerant pipe connection order between outdoor units during installation in case of a multiple outdoor unit system. Install according to following restrictions. The capacities of outdoor units A, B and C must fulfill the following restriction conditions: $A \geq B \geq C$.

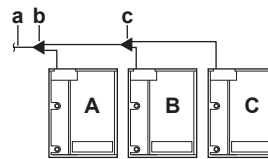

- a To indoor units
- b Outdoor unit multi connecting piping kit (first branch)
- c Outdoor unit multi connecting piping kit (second branch)

4.3 Preparing water piping

4.3.1 Water circuit requirements

NOTICE

In case of plastic pipes, make sure they are fully oxygen diffusion tight according to DIN 4726. The diffusion of oxygen into the piping can lead to excessive corrosion.

- Connecting piping – Legislation.** Make all piping connections in accordance with the applicable legislation and the instructions in the "Installation" chapter, respecting the water inlet and outlet.
- Connecting piping – Force.** Do NOT use excessive force when connecting the piping. Deformation of the piping can cause malfunctioning of the unit.
- Connecting piping – Tools.** Only use appropriate tooling to handle brass, which is a soft material. If NOT, pipes will get damaged.
- Connecting piping – Stainless steel.** Only use stainless steel material to connect the water piping to the unit. If NOT, pipes will get corroded. Take preventive measures, for example by insulating the connection on the water pipe.
- Connecting piping – Air, moisture, dust.** If air, moisture or dust gets into the circuit, problems may occur. To prevent this:
 - Only use clean pipes
 - Hold the pipe end downwards when removing burrs.
 - Cover the pipe end when inserting it through a wall, to prevent dust and/or particles entering the pipe.
 - Use a decent thread sealant to seal connections.
- Piping work – Dripping.** The outdoor unit is intended for indoor installation. Carry out piping work in such a way that no water drips on the outdoor unit.
- Outlets.** Do NOT connect the drain outlet to the water outlet.

- **Filter.** Install the filter in the water piping inlet within a distance of 1.5 m from the outdoor unit. If sand, waste or rust particles are mixed in the water circulation system, metal materials will become corroded.
- **Insulation.** Insulate up to the base of the heat exchanger.

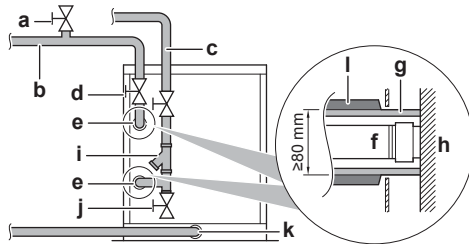

- a Air purge (field supply)
- b Water outlet
- c Water inlet
- d Shut-off valve (field supply)
- e Water connection
- f Water piping (field supply)
- g Insulation (field supply)
- h Heat exchanger
- i Filter (accessory)
- j Drain valve (field supply)
- k Drain connection
- l Insulation cover

- **Water pump.** After filling the water piping, run the water pump (field supply) to flush the water piping. After flushing, clean the filter.
- **Freeze.** Protect against freezing.
- **Water pipes.** ALWAYS comply with local and national regulations.
- **Water piping – Tightening torque.** Securely tighten the water piping with a tightening torque of $\leq 300 \text{ N}\cdot\text{m}$. Overtightening results in damage to the unit.
- **Field supply components – Water.** Only use materials that are compatible with water used in the system and with the materials used in the outdoor unit.
- **Field supply components – Water pressure and temperature.** Check that all components in the field piping can withstand the water pressure and water temperature.
- **Water pressure.** The maximum water pressure is 37 bar. Provide adequate safeguards in the water circuit to ensure that the maximum pressure is NOT exceeded.
- **Drainage – Low points.** Provide drain taps at all low points of the system in order to allow complete drainage of the water circuit.
- **Drainage – Clogging.** Make sure that the water runs smoothly without any clogging by dirt.
- **Drainage – Lateral length.** Lateral length of drainage should be as short as possible ($\leq 400 \text{ mm}$) and installed in a downward direction. The diameter of the drain pipe must be the same as the diameter of the pipe on the outdoor unit.
- **Non-brass metallic piping.** When using non-brass metallic piping, insulate the brass and non-brass properly so that they do NOT make contact with each other. This to prevent galvanic corrosion.

4.3.2 Handling the brazed plate heat exchanger



INFORMATION

A brazed plate heat exchanger is used. Because of a different structure from a conventional heat exchanger, it MUST be handled in a different manner.

- Install a water filter at the water inlet in order to prevent foreign materials such as dust, sand,... from entering the plate heat exchanger.

- Scale can stick to the plate heat exchanger depending on water quality. To remove scale, cleaning is necessary at regular intervals using chemicals. Install a shut-off valve at the end of the water piping. Install a piping connection port on the piping between this shut-off valve and the outdoor unit for cleaning by chemicals.
- For cleaning and water draining of the outdoor unit (long period of non-use or during non-use in winter), install an air purge plug (for joint use with cleaning port) (field supply) and a water draining plug at the inlet/outlet ports of the water piping. Additionally, install an automatic air purge valve (field supply) at the top of rising piping or at the top of a portion where air tends to stay.
- Install an additional cleanable filter (field supply) in front of the pump inlet.
- Carry out complete cooling/thermal insulation of the water piping and the outdoor unit drain piping. If insulation has not been carried out, the unit may sustain damage during severe winters due to freezing, in addition to thermal loss.
- When you stop the unit during night or winter, take measures to prevent water circuits from natural freezing in areas where the ambient temperature drops below 0°C (by water drain off, keeping the circulation pump running, warming up by a heater,...). Freezing of water circuits may result in damage to the plate heat exchanger. Therefore, take appropriate measures depending on the circumstances.

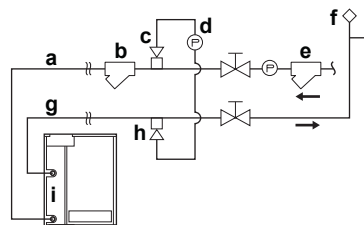

- a Water inlet piping
- b Filter (accessory)
- c Air purge plug (for joint use with cleaning port) (field supply)
- d Cleaning device
- e Filter for pump (field supply)
- f Automatic air purge valve (field supply)
- g Water outlet piping
- h Joint use with water draining plug
- i Plate heat exchanger

4.3.3 About the water flow rate

The RWEYQ*T9Y1B models are equipped with the logic to operate with a variable water flow rate function.

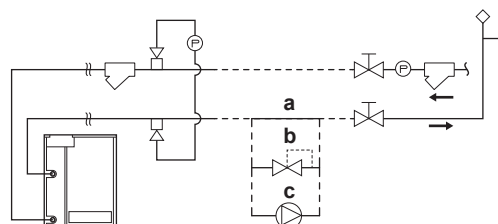

- a Constant flow
- b Flow regulating valve (field supply)
- c Inverter pump (field supply)

A system can either be configured as a constant flow system (a), a variable flow system with valve (b) or a variable flow system with a pump (c).

- Constant flow system (a): the variable water flow rate function is not used.
- A pressure independent flow regulating valve (b): the valve controls the flow rate of a centralized inverter pump through the unit.
- Inverter pump (c): the pump directly controls the water flow rate through the unit.

4 Preparation

To activate the variable flow system, change field setting [2-24] to the applicable value. See "6.1 Making field settings" on page 23.

NOTICE

Make sure that all field supplied equipment for variable flow rate can be switched off together with the outdoor unit. This is required when cleaning the plate heat exchanger.

NOTICE

Make sure that all field supplied equipment for variable flow rate meet the minimum hydronic and electric specifications. Failure to do so can result in inefficient operation or even breakdown of the system.

Size the valve (b) or pump (c) in accordance with the maximum required flow rate A, calculated by the installer of the hydronic system (with respect to the operation range of the outdoor unit). The typical operation range of the flow rate of the valve/pump is 50% (B) to 100% (A).

The valve/pump input signal is based on a variable 2~10 V DC control output signal coming from the outdoor unit. The valve or pump should have a linear control characteristic between unit output signal and flow rate according to the example graph below.

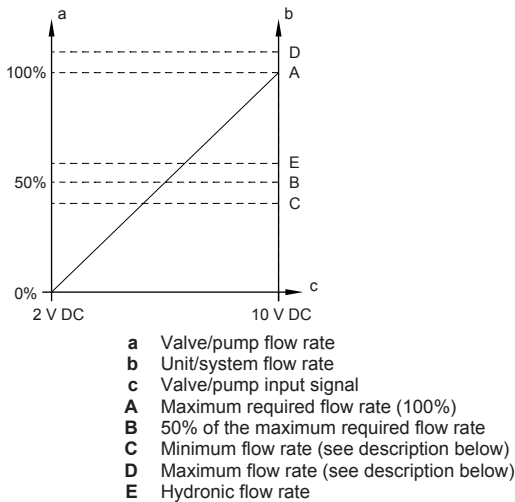

Follow the design criteria below to select the correct valve for the system. The valve system maximum required flow rate **A** is a property of the supplied valve and the 50% flow rate **B** is directly related to the maximum flow rate of the system.

INFORMATION

Some third party valves/pumps have a maximum flow rate defined by the hardware of the system, but a different maximum flow rate can be set to correspond with the maximum input voltage (10 V DC). The installer should ask information to the valve/pump supplier before making the selection.

Design criteria

1 Minimum flow rate **C**:

Model	C
RWEYQ8~12	50 l/min
RWEYQ14	75 l/min

2 Maximum flow rate **D**:

Model	D
RWEYQ8~12	120 l/min
RWEYQ14	190 l/min

3 Hydronic flow rate **E**:

The value **E** is the design flow rate calculated by the hydronic engineer when designing the building system.

Correct valve selection is done when following conditions are met:

(B≥C) AND (E≤A≤D)

For further selection requirements, refer to "4.4 Preparing electrical wiring" on page 12.

Check the minimum flow rate of the system during commissioning to ensure good operation.

During the initialization process of the outdoor unit, the output signal will trigger a flow rate of **B** (50%). The installer should make sure that a flow rate can be checked in the individual hydronic system of each unit. If this value is not matching the required flow, the installer should troubleshoot the hydronic system to solve the problem and ensure the correct flow rate.

4.4 Preparing electrical wiring

4.4.1 Safety device requirements

The power supply must be protected with the required safety devices, i.e. a main switch, a slow blow fuse on each phase and an earth leakage protector in accordance with the applicable legislation.

For single models

Selection and sizing of the wiring should be done in accordance with the applicable legislation based on the information mentioned in the table below.

Model	Minimum circuit ampacity	Recommended fuses
RWEYQ8~14T9	22.3 A	25 A

For all models:

- Phase and frequency: 3N~ 50 Hz
- Voltage: 380~415 V
- Transmission line section: 0.75~1.25 mm², maximum length is 1000 m. If the total transmission wiring exceeds these limits, it may result in communication error.

For free combinations

Calculate the recommended fuse capacity.

Formula	Calculate, by adding the minimum circuit amps of each used unit (according to the table above), multiply the result by 1.1 and select the next higher recommended fuse capacity.
Example	Combining the RWEYQ30T9 by using the RWEYQ8T9, RWEYQ10T9, and RWEYQ12T9. <ul style="list-style-type: none"> Minimum circuit ampacity of the RWEYQ8T9=16.1 A Minimum circuit ampacity of the RWEYQ10T9=22.0 A Minimum circuit ampacity of the RWEYQ12T9=24.0 A Accordingly, the minimum circuit ampacity of the RWEYQ30T9=16.1+22.0+24.0=62.1 A Multiply the above result by 1.1 ⇒ (62.1×1.1)=68.31 A ⇒ the recommended fuse capacity would be 80 A .

NOTICE

When using residual current operated circuit breakers, be sure to use a high-speed type 300 mA rated residual operating current.

5 Installation

5.1 Opening the units

5.1.1 To open the outdoor unit

 **DANGER: RISK OF ELECTROCUTION**

 **DANGER: RISK OF BURNING**

To gain access to the unit, front plates need to be opened as follows:

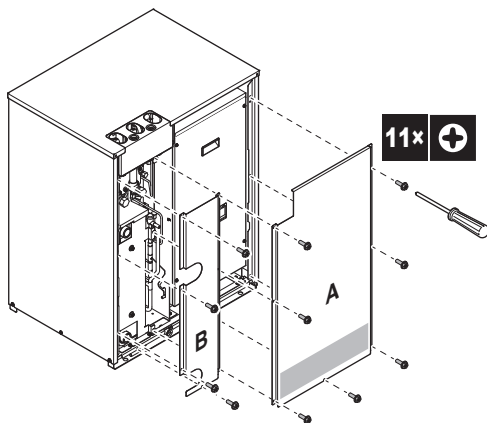

Once the front plate A is open, the electrical component box can be accessed. See "5.1.2 To open the electrical component box of the outdoor unit" on page 13.

For service purposes, the push buttons on the main PCB need to be accessed. To access these push buttons, the electrical component box cover does not need to be opened. See "6.1.3 To access the field setting components" on page 24.

To install the water piping and field wiring, front plate B has to be removed.

5.1.2 To open the electrical component box of the outdoor unit



NOTICE

Do not apply excessive force when opening the electronic component box cover. Excessive force can deform the cover, resulting in entering of water to cause equipment failure.

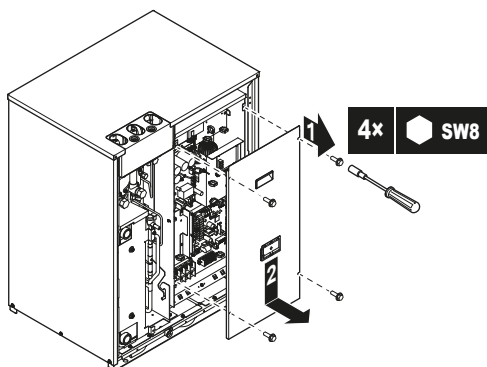

5.2 Mounting the outdoor unit

5.2.1 To provide the installation structure

Make sure the unit is installed level on a sufficiently strong base to prevent vibration and noise.



NOTICE

When the installation height of the unit needs to be increased, do not use stands to only support the corners.

- The preferred installation is on a solid longitudinal foundation (steel beam frame or concrete). The foundation must be larger than the grey marked area.

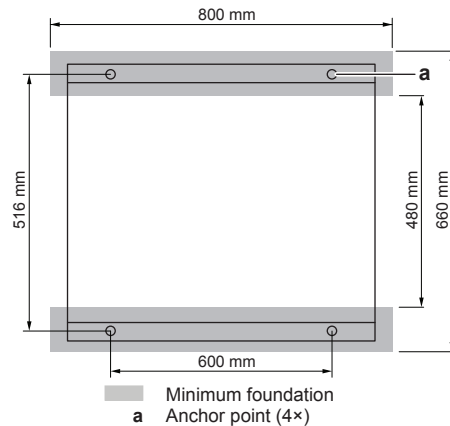

- Fasten the unit in place using four foundation bolts M12. It is best to screw in the foundation bolts until their length remains 20 mm above the foundation surface.

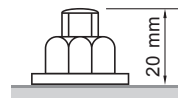

5.3 Connecting the refrigerant piping

5.3.1 To route the refrigerant piping

Installation of refrigerant piping is possible as top connection (standard) or front connection.

In case of top connection:

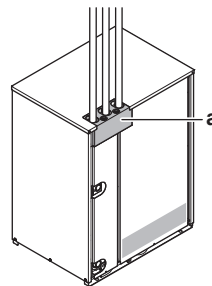

In case of front connection:

Remove and change the position of the pipe service plate (a) as shown in figure below.

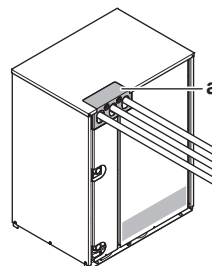

5 Installation

5.3.2 To connect the refrigerant piping to the outdoor unit

NOTICE

- Be sure to use the supplied accessory pipes when carrying out piping work in the field.
- Be sure that the field installed piping does not touch other pipes, the bottom panel or side panel. Especially for the bottom and side connection, be sure to protect the piping with suitable insulation, to prevent it from coming into contact with the casing.

Connect the stop valves to the field piping using the accessory pipes supplied with the unit.

The connections to the branch kits are the responsibility of the installer (field piping).

5.3.3 To connect the multi connection piping kit

NOTICE

Improper installation may lead to malfunction of the outdoor unit.

- Install the joints horizontally, so that the caution label (a) attached to the joint comes to the top.
 - Do not tilt the joint more than 7.5° (see view A).
 - Do not install the joint vertically (see view B).

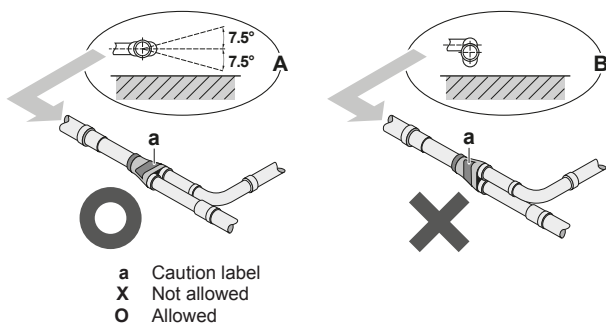

- Make sure that the total length of the piping connected to the joint is absolute straight for more than 500 mm. Only if a straight field piping of more than 120 mm is connected, more than 500 mm of straight section can be ensured.

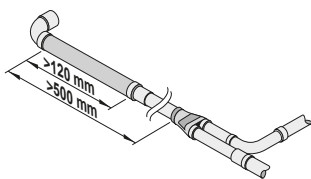

5.3.4 To connect the refrigerant branching kit

For installation of the refrigerant branching kit, refer to the installation manual delivered with the kit.

- Mount the refnet joint so that it branches either horizontally or vertically.
- Mount the refnet header so that it branches horizontally.

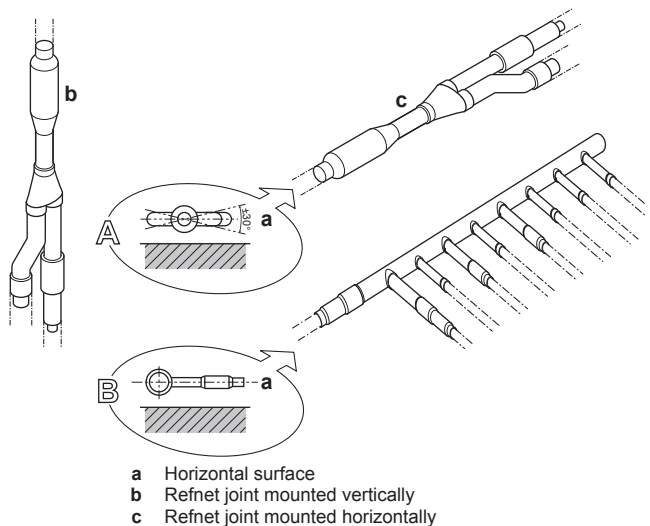

5.3.5 To protect against contamination

Seal the piping and wiring intake holes using sealing material (field supply), otherwise the capacity of the unit will drop and small animals may enter the machine.

5.3.6 Using the stop valve and service port

To handle the stop valve

- Make sure to keep all stop valves open during operation.
- The stop valve is factory closed.

To open the stop valve

- Remove the stop valve cover.
- Insert a hexagon wrench into the stop valve and turn the stop valve counterclockwise.
- When the stop valve cannot be turned any further, stop turning.

Result: The valve is now open.

To fully open the $\varnothing 19.1$ mm- $\varnothing 25.4$ mm stop valve, turn the hexagonal wrench until a torque between 27 and 33 N·m is achieved.

Inadequate torque may cause leakage of refrigerant and breakage of the stop valve cap.

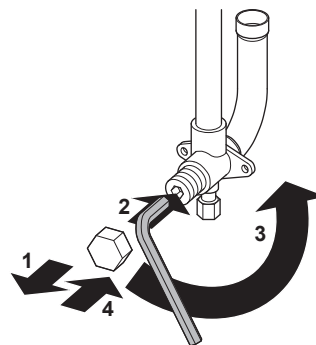

To close the stop valve

- Remove the stop valve cover.
- Insert a hexagon wrench into the stop valve and turn the stop valve clockwise.
- When the stop valve cannot be turned any further, stop turning.

Result: The valve is now closed.

Closing direction:

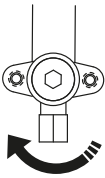

To handle the stop valve cover

- The stop valve cover is sealed where indicated by the arrow. Do NOT damage it.
- After handling the stop valve, tighten the stop valve cover securely, and check for refrigerant leaks. For the tightening torque, refer to the table below.

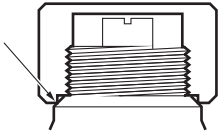

To handle the service port

- Always use a charge hose equipped with a valve depressor pin, since the service port is a Schrader type valve.
- After handling the service port, make sure to tighten the service port cover securely. For the tightening torque, refer to the table below.
- Check for refrigerant leaks after tightening the service port cover.

Tightening torques

Stop valve size (mm)	Tightening torque N·m (turn clockwise to close)			
	Shaft			
	Valve body	Hexagonal wrench	Cap (valve lid)	Service port
Ø9.5	5.4~6.6	4 mm	13.5~16.5	11.5~13.9
Ø12.7	8.1~9.9		18.0~22.0	
Ø15.9	13.5~16.5	6 mm	23.0~27.0	
Ø19.1	27.0~33.0	8 mm	22.5~27.5	
Ø25.4				

5.3.7 To remove the pinched pipes



NOTICE

In case of heat pump mode, do NOT remove the pinched pipe of the gas line stop valve.



WARNING

Any gas or oil remaining inside the stop valve may blow off the pinched piping.

Failure to observe the instructions in procedure below properly may result in property damage or personal injury, which may be serious depending on the circumstances.

Use the following procedure to remove the pinched piping:

- Remove the valve cover and make sure that the stop valves are fully closed.

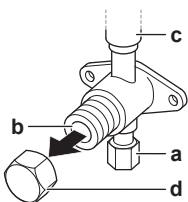

- a Service port and service port cover
- b Stop valve

- c Field piping connection
- d Stop valve cover

- Connect the vacuuming/recovery unit through a manifold to the service port of all stop valves.

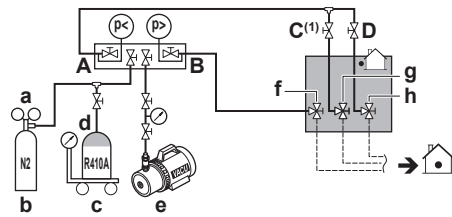

- a Pressure reducing valve
- b Nitrogen
- c Weighing scales
- d Refrigerant R410A tank (siphon system)
- e Vacuum pump
- f Liquid line stop valve
- g Gas line stop valve
- h High pressure/low pressure gas line stop valve
- A Valve A
- B Valve B
- C Valve C⁽¹⁾
- D Valve D

- (1) Only for heat recovery mode.



NOTICE

Do not connect the vacuum pump to the suction gas stop valve if the unit is intended to run in heat pump mode. This will increase the risk of unit failure.

- Recover gas and oil from the pinched piping by using a recovery unit.



CAUTION

Do not vent gases into the atmosphere.

- When all gas and oil is recovered from the pinched piping, disconnect the charge hose and close the service ports.
- Cut off the upper part of the liquid, gas, and high pressure/low pressure gas stop valve pipes along the black line. Use an appropriate tool (e.g. a pipe cutter, a pair of nippers).

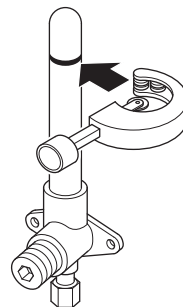

WARNING



Never remove the pinched piping by brazing.

Any gas or oil remaining inside the stop valve may blow off the pinched piping.

- Make sure that no particles remain in the pipe. Blow out any particles with compressed air.
- Wait until all oil is dripped out before continuing with the connection of the field piping in case the recovery was not complete.

5 Installation

5.4 Checking the refrigerant piping

5.4.1 About checking the refrigerant piping

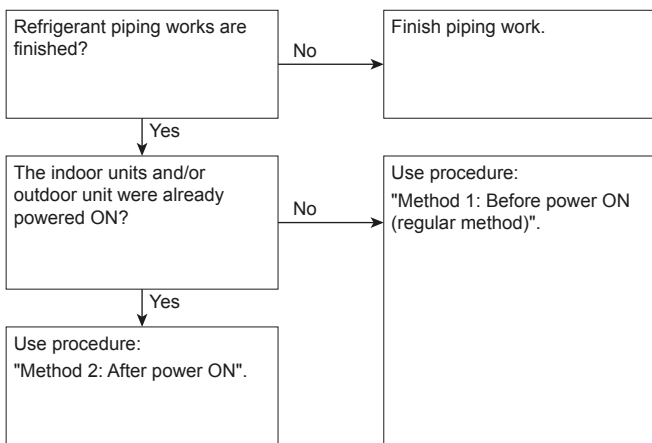

It is very important that all refrigerant piping work is done before the units (outdoor or indoor) are powered on.

When the units are powered on, the expansion valves will initialise. This means that they will close. Leak test and vacuum drying of field piping and indoor units is impossible when this happens.

Therefore, there will be explained 2 methods for initial installation, leak test and vacuum drying.

Method 1: Before power ON

If the system has not yet been powered on, no special action is required to perform the leak test and the vacuum drying.

Method 2: After power ON

If the system has already been powered on, activate setting [2-21] (refer to "6.1.4 To access mode 1 or 2" on page 24). This setting will open field expansion valves to guarantee a R410A piping pathway and make it possible to perform the leak test and the vacuum drying.

NOTICE

Make sure that all indoor units connected to the outdoor unit are powered on.

NOTICE

Wait until the outdoor unit has finished the initialisation to apply setting [2-21].

Leak test and vacuum drying

Checking the refrigerant piping involves:

- Checking for any leakages in the refrigerant piping.
- Performing vacuum drying to remove all moisture, air or nitrogen in the refrigerant piping.

If there is a possibility of moisture being present in the refrigerant piping (for example, water may have entered the piping), first carry out the vacuum drying procedure below until all moisture has been removed.

All piping inside the unit has been factory tested for leaks.

Only field installed refrigerant piping needs to be checked. Therefore, make sure that all the outdoor unit stop valves are firmly closed before performing leak test or vacuum drying.

NOTICE

Make sure that all (field supplied) field piping valves are OPEN (not outdoor unit stop valves!) before you start leak test and vacuuming.

For more information on the state of the valves, refer to "5.4.3 Checking refrigerant piping: Setup" on page 16.

5.4.2 Checking refrigerant piping: General guidelines

Connect the vacuum pump through a manifold to the service port of all stop valves to increase efficiency (refer to "5.4.3 Checking refrigerant piping: Setup" on page 16).

NOTICE

Use a 2-stage vacuum pump with a non-return valve or a solenoid valve that can evacuate to a gauge pressure of -100.7 kPa (-1.007 bar) (5 Torr absolute).

NOTICE

Make sure the pump oil does not flow oppositely into the system while the pump is not working.

NOTICE

Do not purge the air with refrigerants. Use a vacuum pump to evacuate the installation.

5.4.3 Checking refrigerant piping: Setup

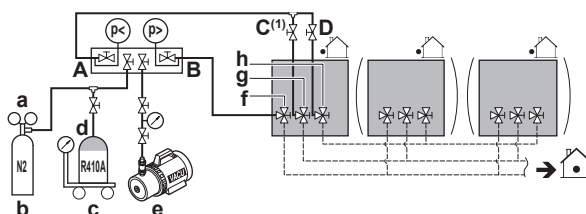

- a Pressure reducing valve
- b Nitrogen
- c Weighing scales
- d Refrigerant R410A tank (siphon system)
- e Vacuum pump
- f Liquid line stop valve
- g Gas line stop valve
- h High pressure/low pressure gas line stop valve
- A Valve A
- B Valve B
- C Valve C⁽¹⁾
- D Valve D

(1) Only for heat recovery mode.

NOTICE

Do not connect the vacuum pump to the suction gas stop valve if the unit is intended to run in heat pump mode. This will increase the risk of unit failure.

Valve	State of valve
Valve A	Open
Valve B	Open
Valve C	Open
Valve D	Open
Liquid line stop valve	Close
Gas line stop valve	Close
High pressure/low pressure gas line stop valve	Close

NOTICE

The connections to the indoor units and all indoor units should also be leak and vacuum tested. Keep any possible (field supplied) field piping valves open as well.

Refer to the indoor unit installation manual for more details. Leak test and vacuum drying should be done before the power supply is set to the unit. If not, see also the flow chart earlier described in this chapter (see "5.4.1 About checking the refrigerant piping" on page 16).

5.4.4 To perform a leak test

The leak test must satisfy the specifications of EN378-2.

To check for leaks: Vacuum leak test

- 1 Evacuate the system from the liquid and gas piping to -100.7 kPa (-1.007 bar) (5 Torr absolute) for more than 2 hours.
- 2 Once reached, turn off the vacuum pump and check that the pressure does not rise for at least 1 minute.
- 3 Should the pressure rise, the system may either contain moisture (see vacuum drying below) or have leaks.

To check for leaks: Pressure leak test

- 1 Break the vacuum by pressurising with nitrogen gas to a minimum gauge pressure of 0.2 MPa (2 bar). Never set the gauge pressure higher than the maximum operation pressure of the unit, i.e. 4.0 MPa (40 bar).
- 2 Test for leaks by applying a bubble test solution to all piping connections.
- 3 Discharge all nitrogen gas.

NOTICE

Make sure to use a recommended bubble test solution from your wholesaler. Do not use soap water, which may cause cracking of flare nuts (soap water may contain salt, which absorbs moisture that will freeze when the piping gets cold), and/or lead to corrosion of flared joints (soap water may contain ammonia which causes a corrosive effect between the brass flare nut and the copper flare).

5.4.5 To perform vacuum drying

To remove all moisture from the system, proceed as follows:

- 1 Evacuate the system for at least 2 hours to a target vacuum of -100.7 kPa (-1.007 bar) (5 Torr absolute).
- 2 Check that, with the vacuum pump turned off, the target vacuum is maintained for at least 1 hour.
- 3 Should you fail to reach the target vacuum within 2 hours or maintain the vacuum for 1 hour, the system may contain too much moisture. In that case, break the vacuum by pressurising with nitrogen gas to a gauge pressure of 0.05 MPa (0.5 bar) and repeat steps 1 to 3 until all moisture has been removed.
- 4 Depending on whether you want to immediately charge refrigerant through the refrigerant charge port or first pre-charge a portion of refrigerant through the liquid line, either open the outdoor unit stop valves, or keep them closed. See "5.6.2 About charging refrigerant" on page 18 for more information.

5.5 To insulate the refrigerant piping

After finishing the leak test and vacuum drying, the piping must be insulated. Take into account the following points:

- Make sure to insulate the connection piping and refrigerant branch kits entirely.

- Be sure to insulate the liquid and gas piping (for all units).
- Use heat resistant polyethylene foam which can withstand a temperature of 70°C for liquid piping and polyethylene foam which can withstand a temperature of 120°C for gas piping.
- Reinforce the insulation on the refrigerant piping according to the installation environment.

Ambient temperature	Humidity	Minimum thickness
$\leq 30^{\circ}\text{C}$	75% to 80% RH	15 mm
$> 30^{\circ}\text{C}$	$\geq 80\%$ RH	20 mm

Condensation might form on the surface of the insulation.

- If there is a possibility that condensation on the stop valve might drip down into the indoor unit through gaps in the insulation and piping because the outdoor unit is located higher than the indoor unit, this must be prevented by sealing up the connections. See below figure.

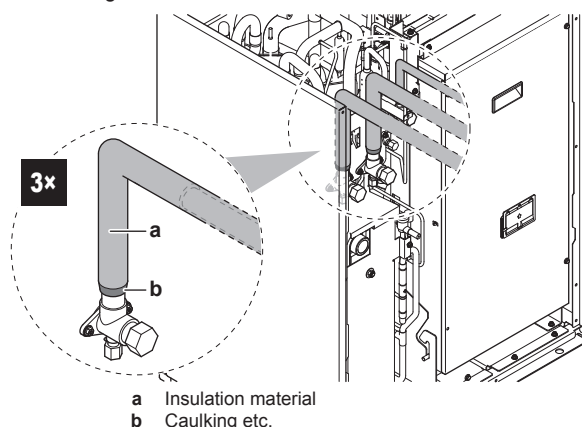
**5.6 Charging refrigerant****5.6.1 Precautions when charging refrigerant****WARNING**

- Only use R410A as refrigerant. Other substances may cause explosions and accidents.
- R410A contains fluorinated greenhouse gases. Its global warming potential (GWP) value is 2087.5. Do NOT vent these gases into the atmosphere.
- When charging refrigerant, always use protective gloves and safety glasses.

**NOTICE**

If the power of some units is turned off, the charging procedure cannot be finished properly.

**NOTICE**

In case of a multiple outdoor system, turn on the power of all outdoor units.

**NOTICE**

Be sure to turn on the power 6 hours before operation in order to have power running to the crankcase heater and to protect the compressor.

**NOTICE**

If operation is performed within 12 minutes after the indoor and outdoor units are turned on, the compressor will not operate before the communication is established in a correct way between outdoor unit(s) and indoor units.

5 Installation

NOTICE

Before starting charging procedures, check if the 7-segment display indication of the outdoor unit A1P PCB is as normal (see "6.1.4 To access mode 1 or 2" on page 24). If a malfunction code is present, see "8.1 Solving problems based on error codes" on page 28.

NOTICE

Close the front panel before any refrigerant charge operation is executed. Without the front panel attached the unit cannot judge correctly whether it is operating properly or not.

5.6.2 About charging refrigerant

The outdoor unit is factory charged with refrigerant, but depending on the field piping you have to charge additional refrigerant.

Make sure the outdoor unit's external refrigerant piping is checked (leak test, vacuum drying).

Charging additional refrigerant typically consists of the following stages:

- 1 Determining how much you have to charge additionally.
- 2 Charging additional refrigerant (pre-charging and/or charging).
- 3 Filling in the fluorinated greenhouse gases label, and fixing it to the inside of the outdoor unit.

5.6.3 To determine the additional refrigerant amount

INFORMATION

For final charge adjustment in the test laboratory, please contact your local dealer.

NOTICE

The refrigerant charge of the system must be less than 100 kg. This means that in case the calculated total refrigerant charge is equal to or more than 95 kg you must divide your multiple outdoor system into smaller independent systems, each containing less than 95 kg refrigerant charge. For factory charge, refer to the unit name plate.

In case of heat pump mode

Formula:

$$R=[(X_1 \times \text{Ø}22.2) \times 0.37 + (X_2 \times \text{Ø}19.1) \times 0.26 + (X_3 \times \text{Ø}15.9) \times 0.18 + (X_4 \times \text{Ø}12.7) \times 0.12 + (X_5 \times \text{Ø}9.5) \times 0.059 + (X_6 \times \text{Ø}6.4) \times 0.022] + A$$

- R Additional refrigerant to be charged [in kg and rounded off to 1 decimal place]
 $X_{1..6}$ Total length [m] of liquid piping size at $\text{Ø}a$
 A Parameter A

Parameter A. If the total indoor unit capacity connection ratio (CR) > 100%, charge an additional 0.5 kg of refrigerant per outdoor unit.

In case of heat recovery mode

Formula:

$$R=[(X_1 \times \text{Ø}22.2) \times 0.37 + (X_2 \times \text{Ø}19.1) \times 0.26 + (X_3 \times \text{Ø}15.9) \times 0.18 + (X_4 \times \text{Ø}12.7) \times 0.12 + (X_5 \times \text{Ø}9.5) \times 0.059 + (X_6 \times \text{Ø}6.4) \times 0.022] \times 1.04 + A + C$$

- R Additional refrigerant to be charged [in kg and rounded off to 1 decimal place]
 $X_{1..6}$ Total length [m] of liquid piping size at $\text{Ø}a$
 A Parameter A
 C Parameter C

Parameter A. If the total indoor unit capacity connection ratio (CR) > 100%, charge an additional 0.5 kg of refrigerant per outdoor unit.

Parameter C. When using more than one multi BS unit, add the sum of the individual BS unit charge factors.

Model	C
BS1Q10	0.05 kg
BS1Q16	0.1 kg
BS1Q25	0.2 kg
BS4Q	0.3 kg
BS6Q	0.4 kg
BS8Q	0.5 kg
BS10Q	0.7 kg
BS12Q	0.8 kg
BS16Q	1.1 kg

Metric piping. When using metric piping, replace the weight factors in the formula by the ones from the following table:

Inch piping		Metric piping	
Piping	Weight factor	Piping	Weight factor
Ø6.4 mm	0.022	Ø6 mm	0.018
Ø9.5 mm	0.059	Ø10 mm	0.065
Ø12.7 mm	0.12	Ø12 mm	0.097
Ø15.9 mm	0.18	Ø15 mm	0.16
		Ø16 mm	0.18
Ø19.1 mm	0.26	Ø18 mm	0.24
Ø22.2 mm	0.37	Ø22 mm	0.35

5.6.4 To charge refrigerant

Follow the steps as described below.

Pre-charging refrigerant

- 1 Calculate the additional amount of refrigerant to be added using the formula mentioned in "5.6.3 To determine the additional refrigerant amount" on page 18.
- 2 The first 10 kg of additional refrigerant can be pre-charged without outdoor unit operation:

If	Then
The additional refrigerant amount is smaller than 10 kg	Perform steps 3~4.
The additional refrigerant charge is larger than 10 kg	Perform steps 3~6.

- 3 Pre-charging can be done without compressor operation, by connecting the refrigerant bottle to the service port of the liquid stop valve (open valve B). Make sure that all outdoor unit stop valves, as well as valves A, C, and D are closed.

NOTICE

During pre-charging, the refrigerant is charged through the liquid line only. Close valves C, D, and A and disconnect the manifold from the gas line and the high pressure/low pressure gas line.

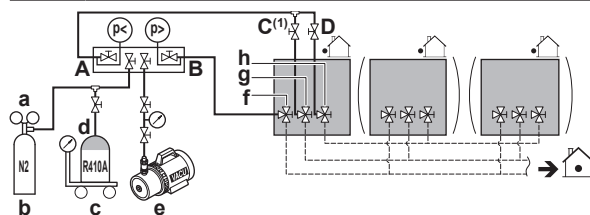

- a Pressure reducing valve
 b Nitrogen
 c Weighing scales
 d Refrigerant R410A tank (siphon system)
 e Vacuum pump
 f Liquid line stop valve

- g Gas line stop valve
- h High pressure/low pressure gas line stop valve
- A Valve A
- B Valve B
- C Valve C⁽¹⁾
- D Valve D

(1) Only for heat recovery mode.



NOTICE

Do not connect the vacuum pump to the suction gas stop valve if the unit is intended to run in heat pump mode. This will increase the risk of unit failure.

4 Do one of the following:

	If	Then
4a	The calculated additional refrigerant amount is reached by above pre-charging procedure	Close valve B and disconnect the manifold from the liquid line.
4b	The total amount of refrigerant could not be charged by pre-charging	Close valve B, disconnect the manifold from the liquid line, and perform steps 5~6.



INFORMATION

If the total additional refrigerant amount was reached in step 4 (by pre-charging only), record the amount of refrigerant that was added on the additional refrigerant charge label provided with the unit and attach it on the back side of the front panel.

Perform the test procedure as described in "7 Commissioning" on page 26.

Charging refrigerant

5 After pre-charging, connect valve A to the refrigerant charge port and charge the remaining additional refrigerant through this port. Open all outdoor unit stop valves. At this point, valve A must remain closed!

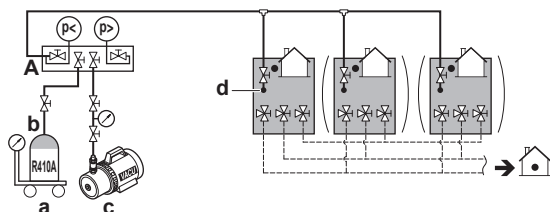

- a Weighing scales
- b Refrigerant R410A tank (siphon system)
- c Vacuum pump
- d Refrigerant charge port
- A Valve A



INFORMATION

For a multi outdoor unit system, it is not required to connect all charge ports to a refrigerant tank.

The refrigerant will be charged with ± 22 kg in 1 hour time at an outdoor temperature of 30°C DB or with ± 6 kg at an outdoor temperature of 0°C DB.

If you need to speed up in case of a multiple outdoor system, connect the refrigerant tanks to each outdoor unit.



NOTICE

- The refrigerant charging port is connected to the piping inside the unit. The unit's internal piping is already factory charged with refrigerant, so be careful when connecting the charge hose.
- After adding the refrigerant, do not forget to close the lid of the refrigerant charging port. The tightening torque for the lid is 11.5 to 13.9 N•m.
- In order to ensure uniform refrigerant distribution, it may take the compressor ± 10 minutes to start up after the unit has started operation. This is not a malfunction.



INFORMATION

The manual refrigerant charge operation will automatically stop within 30 minutes. If charging is not completed after 30 minutes, perform the additional refrigerant charging operation again.



INFORMATION

After charging refrigerant:

- Record the additional refrigerant amount on the refrigerant label provided with the unit and attach it to the backside of the front panel.
- Perform the test procedure described in "7 Commissioning" on page 26.



INFORMATION

Aborting the manual refrigerant charge is possible by pushing BS3. The unit will stop and return to idle condition.

5.6.5 Checks after charging refrigerant

- Are all stop valves open?
- Is the amount of refrigerant, that has been added, recorded on the refrigerant charge label?



NOTICE

Make sure to open all stop valves after (pre-) charging the refrigerant.

Operating with the stop valves closed will damage the compressor.

5.6.6 To fix the fluorinated greenhouse gases label

1 Fill in the label as follows:

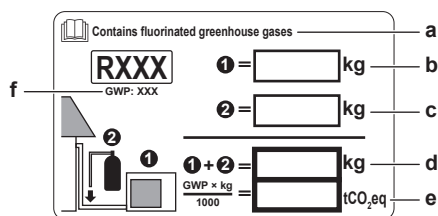

- a If a multilingual fluorinated greenhouse gases label is delivered with the unit (see accessories), peel off the applicable language and stick it on top of a.
- b Factory refrigerant charge: see unit name plate
- c Additional refrigerant amount charged
- d Total refrigerant charge
- e **Greenhouse gas emissions** of the total refrigerant charge expressed as tonnes CO₂-equivalent
- f GWP = Global warming potential

5 Installation

NOTICE

In Europe, the **greenhouse gas emissions** of the total refrigerant charge in the system (expressed as tonnes CO₂-equivalent) is used to determine the maintenance intervals. Follow the applicable legislation.

Formula to calculate the greenhouse gas emissions:
GWP value of the refrigerant × Total refrigerant charge [in kg] / 1000

- Fix the label on the inside of the outdoor unit near the gas and liquid stop valves.

5.7 Connecting the water piping

5.7.1 About connecting the water piping

Before connecting the water piping

Make sure the outdoor and indoor units are mounted.

Typical workflow

Connecting the water piping typically consists of the following stages:

- Connecting the water piping of the outdoor unit.
- Filling the water circuit.
- Insulating the water piping.

5.7.2 To connect the water piping

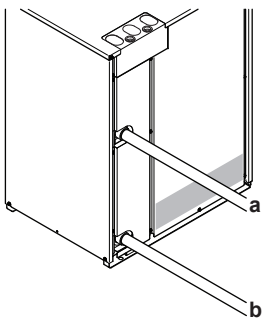

- a Cooling water outlet
- b Cooling water inlet

Consult "4.3.1 Water circuit requirements" on page 10 for the correct tightening torque of the water piping connections.

5.7.3 To fill the water circuit

- Connect the water supply hose to the fill valve (field supply).
- Open the fill valve.
- Run the pump **ONLY** and make sure that no air has been caught in the water circulation system otherwise the plate heat exchanger will freeze.
- Check if the water flow rate is correct, otherwise the plate heat exchanger will freeze. Measure any water pressure loss before and after running the pump and make sure that the flow rate is correct. If not, stop the pump immediately and carry out troubleshooting.

5.7.4 To insulate the water piping

The outdoor water piping **MUST** be insulated to prevent condensation during cooling operation and reduction of the heating and cooling capacity.

See "4.3.1 Water circuit requirements" on page 10 for more information.

5.8 Connecting the electrical wiring

5.8.1 Field wiring: Overview

In case of heat recovery mode

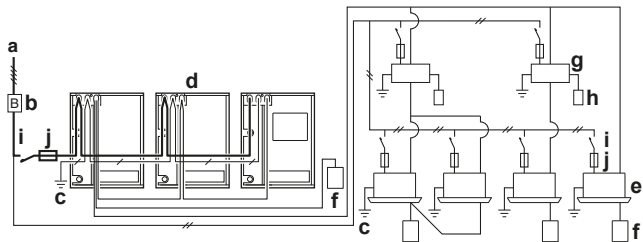

- a Field power supply (with earth leakage protector)
- b Main switch
- c Earth connection
- d Outdoor unit
- e Indoor unit
- f User interface
- g BS unit
- h Cool/heat selector
- i Circuit breaker
- j Fuse
- Power supply 3N~ 50 Hz
- Power supply 1~ 50 Hz
- Earth wiring

In case of heat pump mode

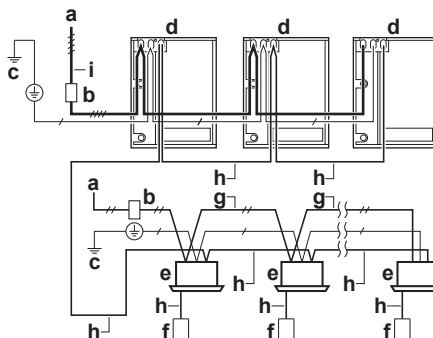

- a Field power supply (with earth leakage protector)
- b Main switch
- c Earth connection
- d Outdoor unit
- e Indoor unit
- f User interface
- g Indoor power supply wiring (sheathed cable) (230 V)
- h Transmission wiring (sheathed cable) (16 V)
- i Outdoor power supply wiring (sheathed cable)
- Power supply 3N~ 50 Hz
- Power supply 1~ 50 Hz
- Earth wiring

5.8.2 To route and fix the transmission wiring

Transmission wiring can be routed through the front side only. Fix it to the upper mounting hole.

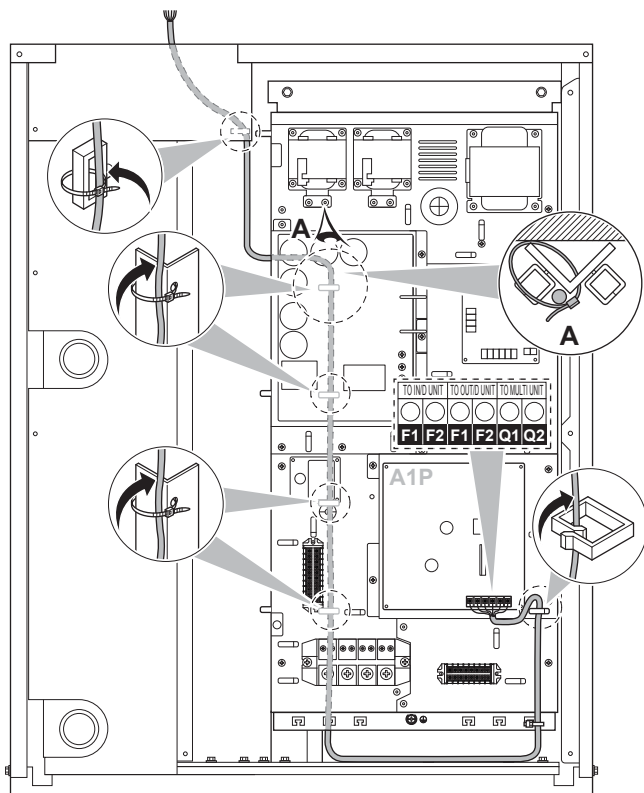

Fix to the indicated plastic brackets (factory installed).

5.8.3 To connect the transmission wiring

The wiring from the indoor units must be connected to the F1/F2 (In-Out) terminals on the PCB in the outdoor unit.

Tightening torque for the transmission wiring terminal screws:

Screw size	Tightening torque (N·m)
M3.5 (A1P)	0.8~0.96

In case of heat recovery mode

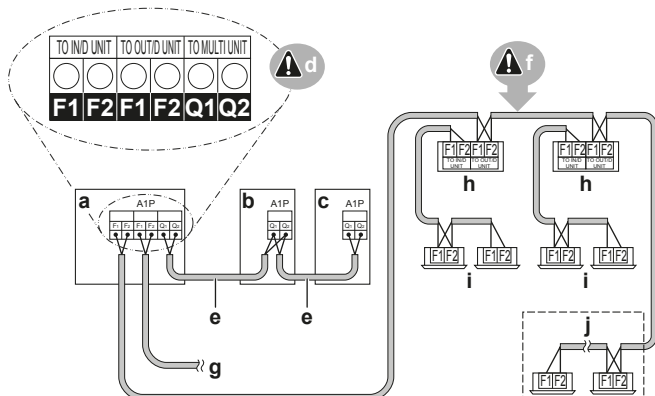

- a Unit A (master outdoor unit)
- b Unit B (slave outdoor unit)
- c Unit C (slave outdoor unit)
- d Outdoor unit PCB (A1P)
- e Master/slave transmission (Q1/Q2)
- f Outdoor/indoor transmission (F1/F2)
- g Outdoor unit/other system transmission (F1/F2)
- h BS unit
- i Indoor unit
- j Cooling-only VRV indoor unit / Heating-only Hydrobox unit

In case of heat pump mode

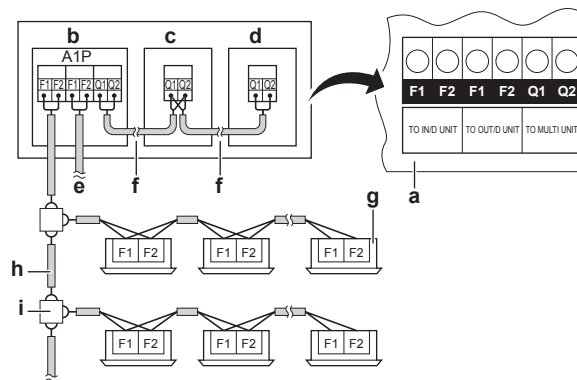

- a Outdoor unit PCB (A1P)
- b Unit A (master outdoor unit)
- c Unit B (slave outdoor unit)
- d Unit C (slave outdoor unit)
- e Outdoor unit/other system transmission (F1/F2)
- f Outdoor-outdoor unit transmission (Q1/Q2)
- g Indoor unit
- h Use the conductor of sheathed wire (2 wire) (no polarity)
- i Terminal board (field supply)

- The interconnecting wiring between the outdoor units in the same piping system must be connected to the Q1/Q2 (Out Multi) terminals. Connecting the wires to the F1/F2 terminals results in system malfunction.
- The wiring for the other systems must be connected to the F1/F2 (Out-Out) terminals of the PCB in the outdoor unit to which the interconnecting wiring for the indoor units is connected.
- The base unit is the outdoor unit to which the interconnecting wiring for the indoor units is connected.

5.8.4 To finish the transmission wiring

After installing the transmission wires inside the unit, wrap them along with the on-site refrigerant pipes using finishing tape, as shown in figure below.

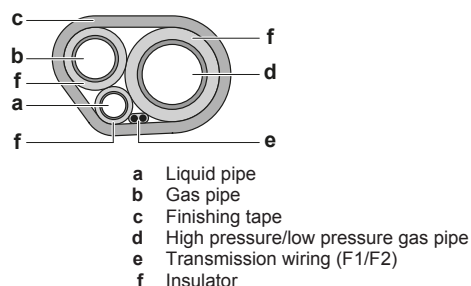

5.8.5 To route and fix the power supply

NOTICE

When routing earth wires, secure clearance of 25 mm or more away from compressor lead wires. Failure to observe this instruction properly may adversely affect correct operation of other units connected to the same earth.

The power supply wiring can be routed from the front side. Exit the wiring via the upper mounting hole.

5 Installation

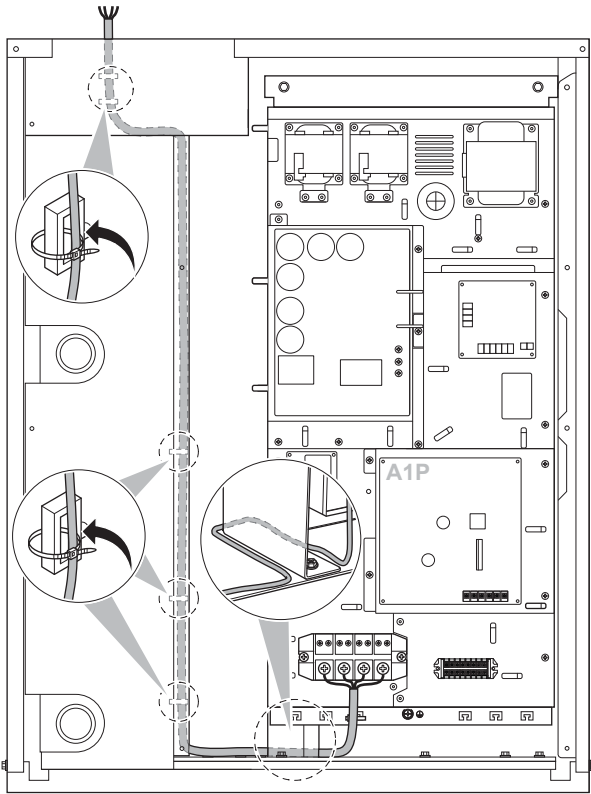

5.8.6 To connect the power supply

The power supply must be clamped to the plastic bracket using field supplied clamp material.

The green and yellow striped wire must be used for earthing only (refer to the figure below).

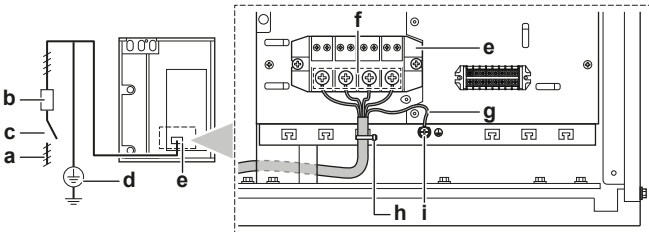

- a Power supply (380~415 V - 3N~ 50 Hz OR 400 V - 3N~ 60 Hz)
- b Fuse
- c Earth leakage protector
- d Earth wire
- e Power supply terminal block
- f Connect each power wire: RED to L1, WHT to L2, BLK to L3 and BLU to N
- g Earth wire (GRN/YLW). When connecting the earth wire, it is recommended to perform curling.
- h Clamp the power supply to the bracket using a field supplied clamp to prevent external force being applied to the terminal.
- i Cup washer.

Multiple outdoor units

To connect the power supply for multiple outdoor units to each other, ring tongues have to be used. No bare cable can be used.

In that case, the ring washer that is installed by default should be removed.

Attach both cables to the power supply terminal as indicated below:

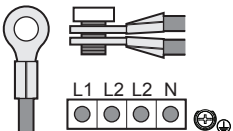

5.8.7 To connect the optional wiring

For the optional wiring use insulated wires of a rated voltage of 250 V or higher and a minimal cross section of 1.25 mm² for single core wires and 0.75 mm² for multicore wires.

Variable water flow

The variable water flow output signal is a low voltage control signal which generates an output of 2~10 V DC depending on the required water flow rate through the plate heat exchanger. For more information, see "4.3.3 About the water flow rate" on page 11.



NOTICE

The maximum output power of the 2~10 V DC output signal is 50 mW. Exceeding this power can result in damage of the system.

Always use shielded cables with a minimal cross section of 0.75 mm² and a length limited to 100 m.

The control line of the valve/pump should be connected to the X2M connector in the electrical switchbox. To connect the valve/pump to the outdoor unit, also provide a separate 12 V DC power supply (with an output power of at least 50 mW) to the X2M connector.

Connect the valve/pump to: X2M terminals 2 and 3.

Connect the power source to X2M terminals 1 and 3 (respect the polarity).

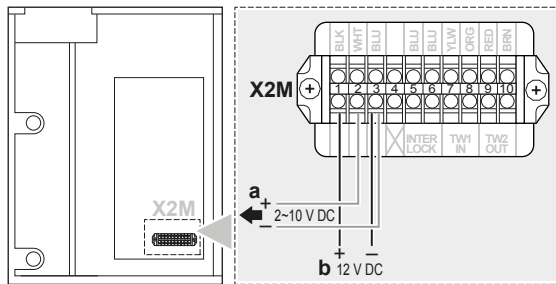

- a Valve/pump
- b Power supply



NOTICE

Make sure to connect a flow switch to your water-cooled VRV IV system. Running the system with a flow rate below the minimum requirement can result in damage of the system.

Interlock

It is mandatory to connect a flow switch to the interlock circuit of the outdoor unit. Running the system with a flow rate below the minimum requirement can result in damage of the system. The flow switch should be installed in the main water circuit between the plate heat exchanger and the closed valve. Select a flow switch contact of at least 15 V DC, 1 mA.

Connect the flow switch to: X2M terminals 5 and 6.

In case of a multi outdoor unit system, install one or more flow switches depending on the installation of the water system so that water flow is guaranteed under every condition.



NOTICE

If the flow switch is installed in a variable water flow system, take into account the inertia of the water flow. If a variable water flow system is used, the flow switch control should be linked to the compressor operation using the multifunction output terminal "b".

Failure to do so will result in unintended "forced thermo off" conditions.

Example:

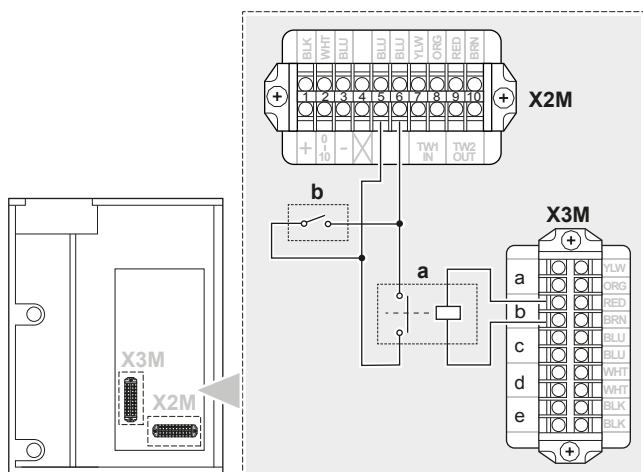

a Relay (normally closed) (field supply)
b Flow switch (field supply)

Multifunction outputs

To monitor the outdoor unit operation or trigger field supplied equipment connected to the outdoor unit, this RWEYQ*T9, series is equipped with 5 output contacts.

General contact specifications: 220 V AC, 3 mA-0.5 mA.

To connect these output signals, choose the applicable contacts in the X3M terminal in the table below:

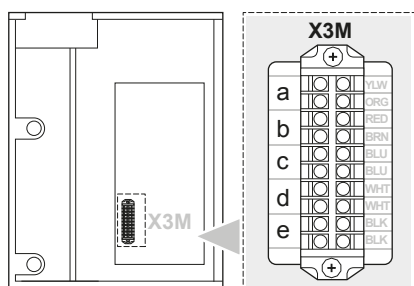

Terminal	Function
a	Error on remote controller
b	Compressor operation
c	Heating operation
d	Cooling operation
e	Water pump operation request

6 Configuration



INFORMATION

It is important that all information in this chapter is read sequentially by the installer and that the system is configured as applicable.



DANGER: RISK OF ELECTROCUTION

6.1 Making field settings

6.1.1 About making field settings

To continue the configuration of the VRV IV heat recovery system, it is required to give some input to the PCB of the unit. This chapter will describe how manual input is possible by operating the push buttons on the PCB and reading the feedback from the 7-segment displays.

Making settings is done via the master outdoor unit.

Next to making field settings it is also possible to confirm the current operation parameters of the unit.

Push buttons

Performing special actions (automatic refrigerant charge, test run, etc.) and making field settings (demand operation, low noise, etc.) happens by way of operating the push buttons.

See also:

- "6.1.2 Field setting components" on page 23
- "6.1.3 To access the field setting components" on page 24

PC configurator

For VRV IV heat recovery system it is alternatively possible to make several commissioning field settings through a personal computer interface (for this, option EKPCAB is required). The installer can prepare the configuration (off-site) on PC and afterwards upload the configuration to the system.

See also: "6.1.9 To connect the PC configurator to the outdoor unit" on page 26.

Mode 1 and 2

Mode	Description
Mode 1 (monitoring settings)	Mode 1 can be used to monitor the current situation of the outdoor unit. Some field setting contents can be monitored as well.
Mode 2 (field settings)	Mode 2 is used to change the field settings of the system. Consulting the current field setting value and changing the current field setting value is possible. In general, normal operation can be resumed without special intervention after changing field settings. Some field settings are used for special operation (e.g., 1 time operation, recovery/vacuuming setting, manual adding refrigerant setting, etc.). In such a case, it is required to abort the special operation before normal operation can restart. It will be indicated in below explanations.

See also:

- "6.1.4 To access mode 1 or 2" on page 24
- "6.1.5 To use mode 1" on page 24
- "6.1.6 To use mode 2" on page 24
- "6.1.7 Mode 1: Monitoring settings" on page 25
- "6.1.8 Mode 2: Field settings" on page 25

6.1.2 Field setting components

Location of the 7-segment displays, buttons and DIP switches:

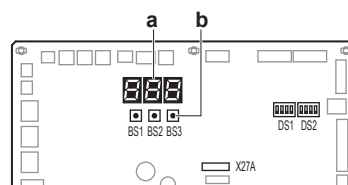

- BS1 MODE: For changing the set mode
- BS2 SET: For field setting
- BS3 RETURN: For field setting
- DS1, DS2 DIP switches
- a 7-segment displays
- b Push buttons

6 Configuration

6.1.3 To access the field setting components

It is not required to open the complete electronic component box to access the push buttons on the PCB and read out the 7-segment display(s).

To access you can remove the front inspection cover of the front plate (see figure). Now you can open the inspection cover of the electrical component box front plate (see figure). You can see the three push buttons and the three 7-segment displays and DIP switches.

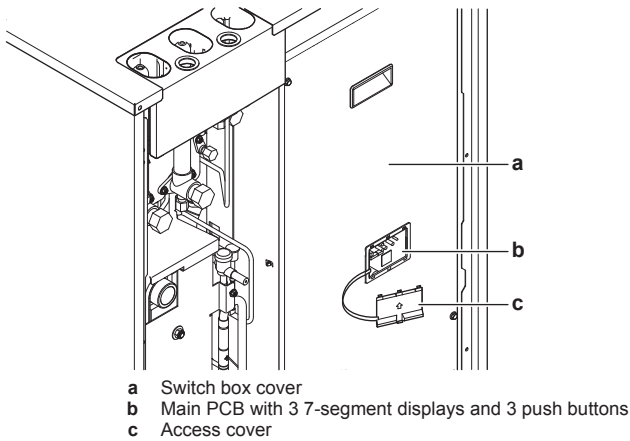

Operate the switches and push buttons with an insulated stick (such as a closed ball-point pen) to avoid touching of live parts.



Make sure to re-attach the inspection cover into the electronic component box cover and to close the front plate's inspection cover after the job is finished. During operation of the unit the front plate of the unit should be attached. Settings are still possible to be made through the inspection opening.

NOTICE

Make sure that all outside panels, except for the service cover on the electrical component box, are closed while working.

Close the lid of the electrical component box firmly before turning on the power.

6.1.4 To access mode 1 or 2

Initialisation: default situation

NOTICE

Be sure to turn on the power 6 hours before operation in order to have power running to the crankcase heater and to protect the compressor.

Turn on the power supply of the outdoor unit and all indoor units. When the communication between indoor units and outdoor unit(s) is established and normal, the 7-segment display indication state will be as below (default situation when shipped from factory).

Stage	Display
When turning on the power supply: flashing as indicated. First checks on power supply are executed (1~2 min).	
When no trouble occurs: lighted as indicated (8~10 min).	
Ready for operation: blank display indication as indicated.	

7-segment display indications:

Off

Blinking
 On

When above situation cannot be confirmed after 12 min, the malfunction code can be checked on the indoor unit user interface and the outdoor unit 7-segment display. Solve the malfunction code accordingly. The communication wiring should be checked at first.

Access

BS1 is used to change the mode you want to access.

Access	Action
Mode 1	Push BS1 one time. 7-segment display indication changes to:
Mode 2	Push BS1 for at least 5 seconds. 7-segment display indication changes to:

INFORMATION

If you get confused in the middle of the process, push BS1. Then it returns to idle situation (no indication on 7-segment displays: blank, refer to "6.1.4 To access mode 1 or 2" on page 24.

6.1.5 To use mode 1

Mode 1 is used to set basic settings and to monitor the status of the unit.

What	How
Changing and accessing the setting in mode 1	Once mode 1 is selected (push BS1 one time), you can select the wanted setting. It is done by pushing BS2. Accessing the selected setting's value is done by pushing BS3 one time.
To quit and return to the initial status	Press BS1.

6.1.6 To use mode 2

The master unit should be used to input field settings in mode 2.

Mode 2 is used to set field settings of the outdoor unit and system.

What	How
Changing and accessing the setting in mode 2	Once mode 2 is selected (push BS1 for more than 5 seconds), you can select the wanted setting. It is done by pushing BS2. Accessing the selected setting's value is done by pushing BS3 1 time.
To quit and return to the initial status	Press BS1.

What	How
Changing the value of the selected setting in mode 2	<ul style="list-style-type: none"> Once mode 2 is selected (push BS1 for more than 5 seconds) you can select the wanted setting. It is done by pushing BS2. Accessing the selected setting's value is done by pushing BS3 1 time. Now BS2 is used to select the required value of the selected setting. When the required value is selected, you can define the change of value by pushing BS3 1 time. Press BS3 again to start operation according to the chosen value.

6.1.7 Mode 1: Monitoring settings

[1-0]

Shows whether the unit you check is a master, slave 1 or slave 2 unit.

The master unit should be used to input field settings in mode 2.

[1-0]	Description
No indication	Undefined situation.
0	Outdoor unit is master unit.
1	Outdoor unit is slave 1 unit.
2	Outdoor unit is slave 2 unit.

[1-1]

Shows the status of low noise operation.

[1-1]	Description
0	Unit is currently not operating under low noise restrictions.
1	Unit is currently operating under low noise restrictions.

[1-2]

Shows the status of power consumption limitation operation.

[1-2]	Description
0	Unit is currently not operating under power consumption limitations.
1	Unit is currently operating under power consumption limitation.

[1-5] [1-6]

Shows:

- [1-5]: The current T_e target parameter position.
- [1-6]: The current T_c target parameter position.

[1-13]

Shows the total number of connected outdoor units (in case of multiple outdoor system).

[1-17] [1-18] [1-19]

Shows:

- [1-17]: The latest malfunction code.
- [1-18]: The 2nd last malfunction code.
- [1-19]: The 3rd last malfunction code.

6.1.8 Mode 2: Field settings

[2-8]

T_e target temperature during cooling operation.

[2-8]	T_e target (°C)
1	3°C
2 (default)	6°C
3	7°C
4	8°C
5	9°C
6	10°C
7	11°C

[2-9]

T_c target temperature during heating operation without variable refrigerant temperature (VRT) control.

[2-9]	T_c target (°C)
1	41°C
2	42°C
3	43°C
4	44°C
5	45°C
6 (default)	46°C
7	49°C

[2-20]

Manual additional refrigerant charge.

[2-20]	Description
0 (default)	Deactivated.
1	Activated. To stop the manual additional refrigerant charge operation (when the required additional refrigerant amount is charged), push BS3. If this function was not aborted by pushing BS3, the unit will stop its operation after 30 minutes. If 30 minutes was not sufficient to add the needed refrigerant amount, the function can be reactivated by changing the field setting again.

[2-23]

Variable refrigerant temperature (VRT) control

[2-23]	VRT control
0 (default)	Activated both cooling and heating
1	Activated heating only
2	Activated cooling only
3	Deactivated

[2-24]

Water pump/valve control.

To activate the variable flow system, change the setting to the applicable value.

[2-24]	Water pump control
0 (default)	OFF
1	Each unit has a pump/valve
2	One pump/valve per system
3	Each unit has a pump/valve (pump is OFF when slave unit does not operate)

7 Commissioning

[2-50]

Brine type setting.

By changing this setting, you can extend the operation range at the brine side of the unit.

- Normal operation range at brine side (default): for use with water as heat source medium.
- Extended operation range at brine side (default): for use with brine as heat source medium.

NOTICE

By changing this setting to extended operation type, glycol (40%) must be used as heat source medium to avoid freeze up of the brine circuit or unit itself (cf. operation range). Do not use water in this case!

[2-50]	Description
0 (default)	No brine: water. Extended range impossible.
3	Use brine: glycol (40%). Extended range possible.

[2-73]

Zero energy dissipation control setting.

[2-73]	Description
0 (default)	OFF
1	ON (with priority on cooling capacity)
2	ON (with priority on zero energy dissipation)

Zero energy dissipation control can be OFF if the mechanical room is already equipped with a ventilation system or air conditioning system for other facilities.

[2-74]

Zero energy dissipation setting temperature.

If the unit internal temperature is higher than the zero energy dissipation setting temperature, the zero energy dissipation control will start and cool down the unit.

[2-74]	Description
0	25
1	27
2	29
3 (default)	31
4	33
5	35
6	37
7	39

6.1.9 To connect the PC configurator to the outdoor unit

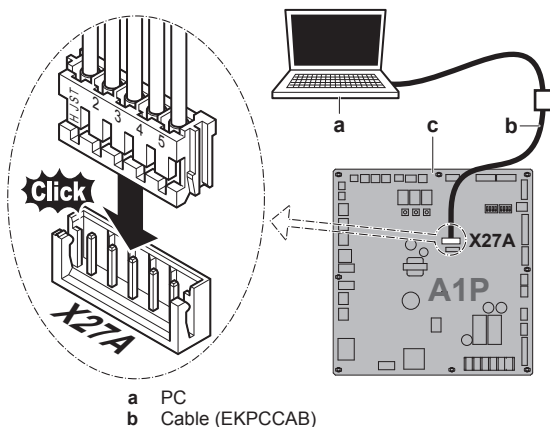

c Outdoor unit main PCB

7 Commissioning

After installation and once the field settings are defined, the installer is obliged to verify correct operation. Therefore a test run must be performed according to the procedures described below.

7.1 Precautions when commissioning



CAUTION

Do not perform the test operation while working on the indoor units.

When performing the test operation, not only the outdoor unit, but the connected indoor unit will operate as well. Working on an indoor unit while performing a test operation is dangerous.



NOTICE

Be sure to turn on the power 6 hours before operation in order to have power running to the crankcase heater and to protect the compressor.

During test operation, the outdoor unit and the indoor units will start up. Make sure that the preparations of all indoor units are finished (field piping, electrical wiring, air purge, ...). See installation manual of the indoor units for details.

7.2 Checklist before commissioning

After the installation of the unit, first check the following items. Once all below checks are fulfilled, the unit must be closed, only then can the unit be powered up.

<input type="checkbox"/>	You read the complete installation and operation instructions, as described in the installer and user reference guide .
<input type="checkbox"/>	Installation Check that the unit is properly installed, to avoid abnormal noises and vibrations when starting up the unit.
<input type="checkbox"/>	Field wiring Be sure that the field wiring has been carried out according to the instructions described in the chapter "5.8 Connecting the electrical wiring" on page 20, according to the wiring diagrams and according to the applicable legislation.
<input type="checkbox"/>	Power supply voltage Check the power supply voltage on the local supply panel. The voltage must correspond to the voltage on the identification label of the unit.
<input type="checkbox"/>	Earth wiring Be sure that the earth wires have been connected properly and that the earth terminals are tightened.
<input type="checkbox"/>	Insulation test of the main power circuit Using a megatester for 500 V, check that the insulation resistance of 2 MΩ or more is attained by applying a voltage of 500 V DC between power terminals and earth. Never use the megatester for the transmission wiring.
<input type="checkbox"/>	Fuses, circuit breakers, or protection devices Check that the fuses, circuit breakers, or the locally installed protection devices are of the size and type specified in the chapter "4.4.1 Safety device requirements" on page 12. Be sure that neither a fuse nor a protection device has been bypassed.

<input type="checkbox"/>	Internal wiring Visually check the electrical component box and the inside of the unit on loose connections or damaged electrical components.
<input type="checkbox"/>	Pipe size and pipe insulation Be sure that correct pipe sizes are installed and that the insulation work is properly executed.
<input type="checkbox"/>	Stop valves Be sure that the stop valves are open on both liquid and gas side.
<input type="checkbox"/>	Damaged equipment Check the inside of the unit on damaged components or squeezed pipes.
<input type="checkbox"/>	Refrigerant leak Check the inside of the unit on refrigerant leakage. If there is a refrigerant leak, try to repair the leak. If the repair is unsuccessful, call your local dealer. Do not touch any refrigerant which has leaked out from refrigerant piping connections. This may result in frostbite.
<input type="checkbox"/>	Oil leak Check the compressor for oil leakage. If there is an oil leak, try to repair the leak. If the repairing is unsuccessful, call your local dealer.
<input type="checkbox"/>	Air inlet/outlet Check that the air inlet and outlet of the unit is not obstructed by paper sheets, cardboard, or any other material.
<input type="checkbox"/>	Additional refrigerant charge The amount of refrigerant to be added to the unit shall be written on the included "Added refrigerant" plate and attached to the rear side of the front cover.
<input type="checkbox"/>	Installation date and field setting Be sure to keep record of the installation date on the sticker on the rear of the upper front panel according to EN60335-2-40 and keep record of the contents of the field setting(s).
<input type="checkbox"/>	Inspect the water filter at the inlet piping of the outdoor unit. Clean if it is dirty.
<input type="checkbox"/>	The piping work has been carried out according to this document and the applicable legislation. Make sure that following components are positioned at their correct places: <ul style="list-style-type: none"> ▪ water filter, ▪ air purge valve, ▪ automatic water supply valve, and ▪ expansion tank.
<input type="checkbox"/>	Water circuit Make sure that the water circuit is filled.
<input type="checkbox"/>	Water flow Make sure that the calculated water flow rate can be reached.

7.3 About test run

The procedure below describes the test operation of the complete system. This operation checks and judges following items:

- Check for incorrect wiring (communication check with indoor units).
- Check of the stop valves opening.
- Judgement of piping length.

In case Hydrobox units are present in the system, the pipe length check and the refrigerant situation check will not be performed.

- Make sure to carry out the system test operation after the first installation. Otherwise, the malfunction code *U3* will be displayed on the user interface and normal operation or individual indoor unit test run cannot be carried out.
- Abnormalities on indoor units cannot be checked for each unit separately. After the test operation is finished, check the indoor units one by one by performing a normal operation using the user interface. Refer to the indoor unit installation manual for more details (e.g., Hydrobox) concerning the individual test run.



INFORMATION

- It may take 10 minutes to achieve a uniform refrigerant state before the compressor starts.
- During the test operation, the refrigerant running sound or the magnetic sound of a solenoid valve may become loud and the display indication may change. These are not malfunctions.

7.4 To perform a test run

- 1 Close all front panels in order to not let it be the cause of misjudgement (except the electrical component box inspection opening service cover).
- 2 Make sure all field settings you want are set; see "6.1 Making field settings" on page 23.
- 3 Turn ON the power to the outdoor unit and the connected indoor units.



NOTICE

Be sure to turn on the power 6 hours before operation in order to have power running to the crankcase heater and to protect the compressor.

- 4 Make sure the default (idle) situation is existing; see "6.1.4 To access mode 1 or 2" on page 24. Push BS2 for 5 seconds or more. The unit will start test operation.

Result: The test operation is automatically carried out, the outdoor unit display will indicate "t0 /" and the indication "Test operation" and "Under centralised control" will display on the user interface of indoor units.

Steps during the automatic system test run procedure:

Step	Description
t01	Control before start up (pressure equalisation)
t02	Cooling start up control
t03	Cooling stable condition
t04	Communication check
t05	Stop valve check
t06	Pipe length check
t07	Refrigerant amount check
t09	Pump down operation
t10	Unit stop

Note: During the test operation, it is not possible to stop the unit operation from a user interface. To abort the operation, press BS3. The unit will stop after ±30 seconds.

- 5 Check the test operation results on the outdoor unit 7-segment display.

Completion	Description
Normal completion	No indication on the 7-segment display (idle).

8 Troubleshooting

Completion	Description
Abnormal completion	<p>Indication of malfunction code on the 7-segment display.</p> <p>Refer to "7.5 Correcting after abnormal completion of the test run" on page 28 to take actions for correcting the abnormality. When the test operation is fully completed, normal operation will be possible after 5 minutes.</p>

7.5 Correcting after abnormal completion of the test run

The test operation is only completed if there is no malfunction code displayed on the user interface or outdoor unit 7-segment display. In case of a displayed malfunction code, perform correcting actions as explained in the malfunction code table. Carry out the test operation again and confirm that the abnormality is properly corrected.

i INFORMATION

Refer to the installation manual of the indoor unit for detailed malfunction codes related to indoor units.

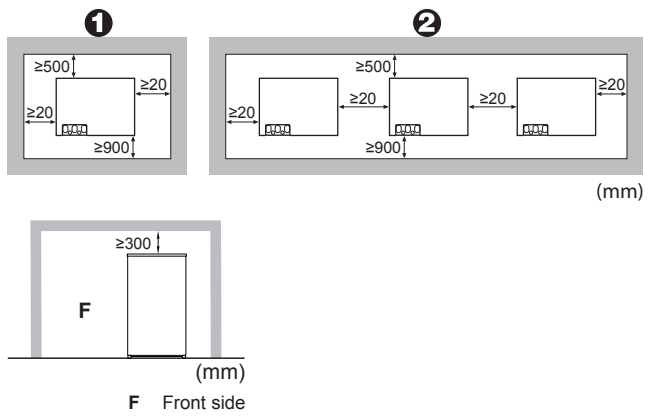

i INFORMATION

Further specifications can be found in the technical engineering data.

8 Troubleshooting

8.1 Solving problems based on error codes

In case of a displayed malfunction code, perform correcting actions as explained in the malfunction code table.

After correcting the abnormality, press BS3 to reset the malfunction code and retry operation.

The malfunction code which is displayed on the outdoor unit will indicate a main malfunction code and a sub code. The sub code indicates more detailed information about the malfunction code. The malfunction code will be displayed intermittent.

Example:

Code	Example
Main code	E3
Sub code	-01

With an interval of 1 second, the display will switch between main code and sub code.

9 Technical data









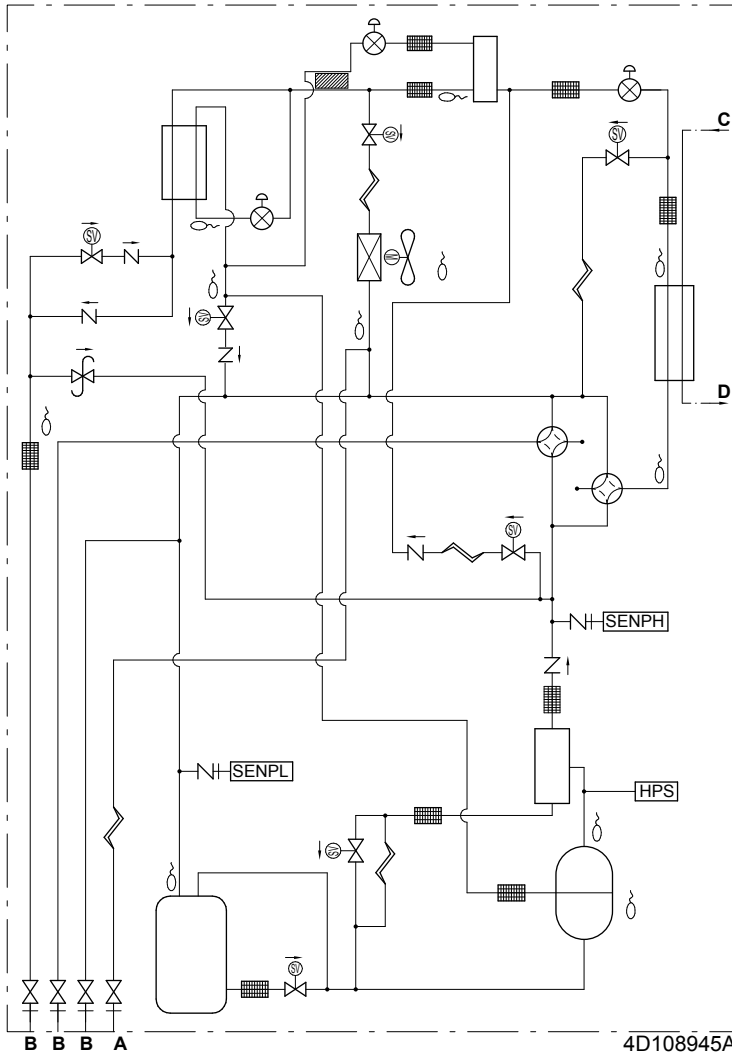



- A **subset** of the latest technical data is available on the regional Daikin website (publicly accessible).
- The **full set** of latest technical data is available on the Daikin extranet (authentication required).







9.1 Service space: Outdoor unit

Make sure the space around the unit is adequate for servicing and the minimum space for ventilation is available (refer to the figure below).

9.2 Piping diagram: Outdoor unit



- A** Charge port
- B** Stop valve (with service port $\varnothing 7.9$ mm flare connection)
- C** Cooling water inlet
- D** Cooling water outlet
-  Charge port / Service port
-  Filter
-  Check valve
-  Pressure relief valve
-  Solenoid valve
-  Capillary tube
-  Electronic expansion valve
-  4-way valve
-  Propeller fan
-  Port (for sensor)
-  Low/high pressure sensor
-  High pressure switch

-  Oil separator
-  Accumulator
-  Compressor
-  Double tube heat exchanger
-  Liquid receiver
-  Thermistor

For the user

10 About the system

The indoor unit part of VRV IV heat recovery system can be used for heating/cooling applications. The type of indoor unit which can be used depends on the outdoor units series.

NOTICE

For future modifications or expansions of your system:

A full overview of allowable combinations (for future system extensions) is available in technical engineering data and should be consulted. Contact your installer to receive more information and professional advice.

10.1 System layout

Heat recovery system

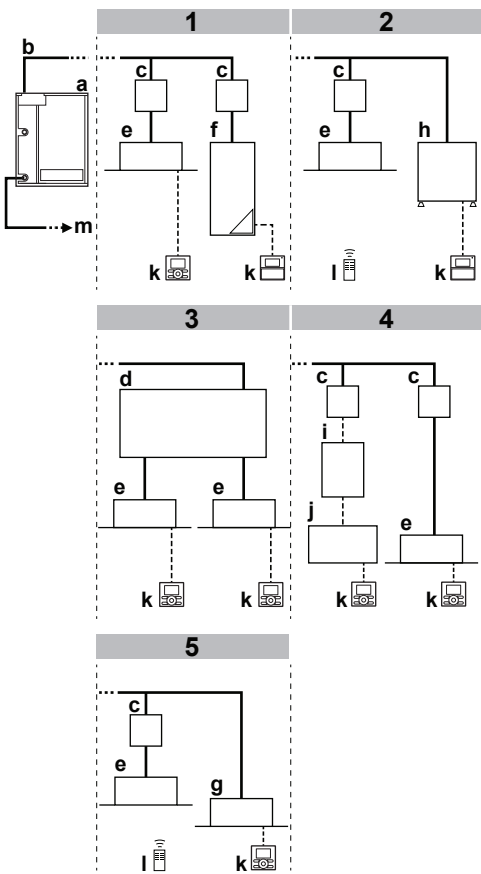

- a Unit
- b Refrigerant piping
- c BS unit
- d Multi BS unit
- e VRV DX indoor unit
- f LT Hydrobox unit
- g Cooling only VRV indoor unit
- h HT Hydrobox unit
- i EKEXV kit
- j AHU
- k User interface
- l Wireless user interface
- m Water system connection

Heat pump system

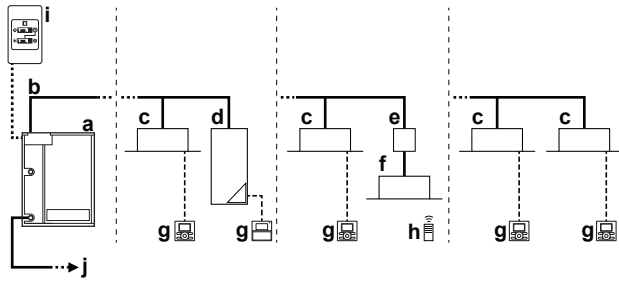

- a Unit
- b Refrigerant piping
- c VRV DX indoor unit
- d LT Hydrobox unit
- e BP box (required to connect Residential Air (RA) or Sky Air (SA) direct expansion (DX) indoor units)
- f Residential Air (RA) direct expansion (DX) indoor units
- g User interface
- h Wireless user interface
- i Cool/heat changeover remote control switch
- j Water system connection

Water system

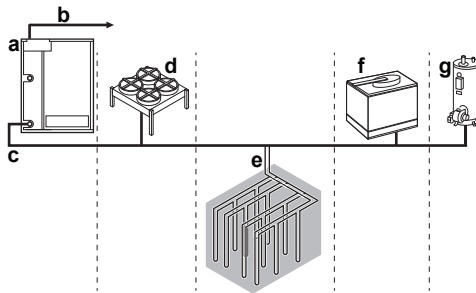

- a Unit
- b Connection to refrigerant system
- c Water piping
- d Dry cooler
- e Brine loop
- f Closed cooling tower
- g Boiler

11 User interface



CAUTION

Never touch the internal parts of the controller.

Do not remove the front panel. Some parts inside are dangerous to touch and appliance problems may happen. For checking and adjusting the internal parts, contact your dealer.

This operation manual will give a non-exhaustive overview of the main functions of the system.

Detailed information on required actions to achieve certain functions can be found in the dedicated installation and operation manual of the indoor unit.

Refer to the operation manual of the installed user interface.

12 Operation

12.1 Operation range

Use the system in the following temperature and humidity ranges for safe and effective operation.

Above operation range is only valid in case direct expansion indoor units are connected to the VRV IV system.

Special operation ranges are valid in case of using Hydrobox units or AHU. They can be found in the installation/operation manual of the dedicated unit. Latest information can be found in the technical engineering data.

12.2 Operating the system

12.2.1 About operating the system

- Operation procedure varies according to the combination of outdoor unit and user interface.
- To protect the unit, turn on the main power switch 6 hours before operation.
- If the main power supply is turned off during operation, operation will restart automatically after the power turns back on again.

12.2.2 About cooling, heating, fan only, and automatic operation

- Changeover cannot be made with a user interface whose display shows "change-over under centralised control" (refer to installation and operation manual of the user interface).
- When the display "change-over under centralised control" flashes, refer to "12.5.1 About setting the master user interface" on page 32.
- The fan may keep on running for about 1 minute after the heating operation stops.
- The air flow rate may adjust itself depending on the room temperature or the fan may stop immediately. This is not a malfunction.

12.2.3 About the heating operation

It may take longer to reach the set temperature for general heating operation than for cooling operation.

The following operation is performed in order to prevent the heating capacity from dropping or cold air from blowing.

Defrost operation

In heating operation, freezing of the outdoor unit's air cooled coil increases over time, restricting the energy transfer to the outdoor unit's coil. Heating capability decreases and the system needs to go into defrost operation to be able to deliver enough heat to the indoor units.

In case of	Then
RWEYQ16~42 multi-models	The indoor unit will continue heating operation at a reduced level during defrost operation. It will guarantee a decent comfort level indoor.
RWEYQ8~14 single models	The indoor unit will stop fan operation, the refrigerant cycle will reverse and energy from inside the building will be used to defrost the outdoor unit coil.

The indoor unit will indicate defrost operation on the display .

Hot start

In order to prevent cold air from blowing out of an indoor unit at the start of heating operation, the indoor fan is automatically stopped. The display of the user interface shows . It may take some time before the fan starts. This is not a malfunction.

12.2.4 To operate the system (WITHOUT cool/heat changeover remote control switch)

- 1 Press the operation mode selector button on the user interface several times and select the operation mode of your choice.

- Cooling operation
- Heating operation
- Fan only operation

- 2 Press the ON/OFF button on the user interface.

Result: The operation lamp lights up and the system starts operating.

12.2.5 To operate the system (WITH cool/heat changeover remote control switch)

Overview of the changeover remote control switch

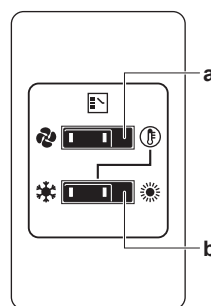

a FAN ONLY/AIR CONDITIONING SELECTOR SWITCH

Set the switch to for fan only operation or to for heating or cooling operation.

b COOL/HEAT CHANGEOVER SWITCH

Set the switch to for cooling or to for heating

To start

- 1 Select operation mode with the cool/heat changeover switch as follows:

Cooling operation Heating operation Fan only operation

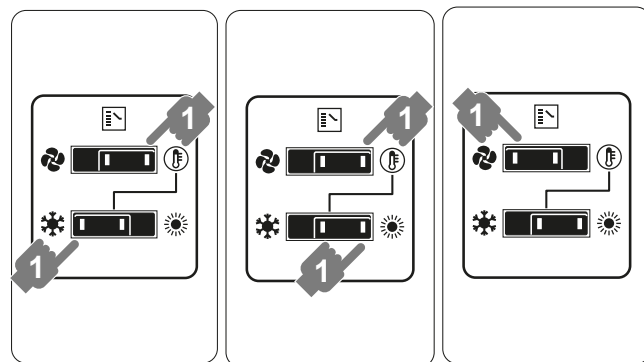

- 2 Press the ON/OFF button on the user interface.

Result: The operation lamp lights up and the system starts operating.

To stop

- 3 Press the ON/OFF button on the user interface once again.

Result: The operation lamp goes out and the system stops operating.



NOTICE

Do not turn off power immediately after the unit stops, but wait for at least 5 minutes.

13 Maintenance and service

To adjust

For programming temperature, fan speed and air flow direction refer to the operation manual of the user interface.

12.3 Using the dry program

12.3.1 About the dry program

- The function of this program is to decrease the humidity in your room with minimal temperature decrease (minimal room cooling).
- The micro computer automatically determines temperature and fan speed (cannot be set by the user interface).
- The system does not go into operation if the room temperature is low (<20°C).

12.3.2 To use the dry program (WITHOUT cool/heat changeover remote control switch)

To start

- 1 Press the operation mode selector button on the user interface several times and select  (program dry operation).
- 2 Press the ON/OFF button of the user interface.
Result: The operation lamp lights up and the system starts operating.
- 3 Press the air flow direction adjust button (only for double-flow, multi-flow, corner, ceiling-suspended and wall-mounted). Refer to "12.4 Adjusting the air flow direction" on page 32 for details.

To stop

- 4 Press the ON/OFF button on the user interface once again.

Result: The operation lamp goes out and the system stops operating.



NOTICE

Do not turn off power immediately after the unit stops, but wait for at least 5 minutes.

12.3.3 To use the dry program (WITH cool/heat changeover remote control switch)

To start

- 1 Select cooling operation mode with the cool/heat changeover remote control switch.

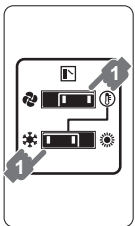

- 2 Press the operation mode selector button on the user interface several times and select  (program dry operation).
- 3 Press the ON/OFF button of the user interface.
Result: The operation lamp lights up and the system starts operating.
- 4 Press the air flow direction adjust button (only for double-flow, multi-flow, corner, ceiling-suspended and wall-mounted). Refer to "12.4 Adjusting the air flow direction" on page 32 for details.

To stop

- 5 Press the ON/OFF button on the user interface once again.

Result: The operation lamp goes out and the system stops operating.



NOTICE

Do not turn off power immediately after the unit stops, but wait for at least 5 minutes.

12.4 Adjusting the air flow direction

Refer to the operation manual of the user interface.

12.4.1 About the air flow flap

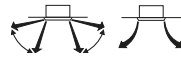

Double flow+multi-flow units

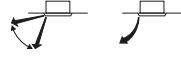

Corner units

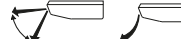

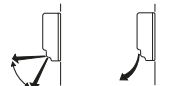

Ceiling suspended units



Wall-mounted units

For the following conditions, a micro computer controls the air flow direction which may be different from the display.

The air flow direction can be adjusted in one of the following ways:

- The air flow flap itself adjusts its position.
- The air flow direction can be fixed by the user.
- Automatic  and desired position .



WARNING

Never touch the air outlet or the horizontal blades while the swing flap is in operation. Fingers may become caught or the unit may break down.



NOTICE

- The movable limit of the flap is changeable. Contact your dealer for details. (only for double-flow, multi-flow, corner, ceiling-suspended and wall-mounted).
- Avoid operating in the horizontal direction . It may cause dew or dust to settle on the ceiling or flap.

12.5 Setting the master user interface

12.5.1 About setting the master user interface

The displays of slave user interfaces show  (change-over under centralised control) and slave user interfaces automatically follow the operation mode directed by the master user interface.

Only the master user interface can select heating or cooling mode.

13 Maintenance and service



NOTICE

Never inspect or service the unit by yourself. Ask a qualified service person to perform this work.



WARNING

Never replace a fuse with a fuse of a wrong ampere ratings or other wires when a fuse blows out. Use of wire or copper wire may cause the unit to break down or cause a fire.



CAUTION

Do not insert fingers, rods or other objects into the air inlet or outlet. Do not remove the fan guard. When the fan is rotating at high speed, it will cause injury.



CAUTION

After a long use, check the unit stand and fitting for damage. If damaged, the unit may fall and result in injury.



NOTICE

Do not wipe the controller operation panel with benzine, thinner, chemical dust cloth, etc. The panel may get discoloured or the coating peeled off. If it is heavily dirty, soak a cloth in water-diluted neutral detergent, squeeze it well and wipe the panel clean. Wipe it with another dry cloth.

13.1 About the refrigerant

This product contains fluorinated greenhouse gases. Do NOT vent gases into the atmosphere.

Refrigerant type: R410A

Global warming potential (GWP) value: 2087.5



NOTICE

In Europe, the **greenhouse gas emissions** of the total refrigerant charge in the system (expressed as tonnes CO₂-equivalent) is used to determine the maintenance intervals. Follow the applicable legislation.

Formula to calculate the greenhouse gas emissions:
GWP value of the refrigerant × Total refrigerant charge [in kg] / 1000

Please contact your installer for more information.



WARNING

The refrigerant in the system is safe and normally does not leak. If the refrigerant leaks in the room, contact with a fire of a burner, a heater or a cooker may result in a harmful gas.

Turn off any combustible heating devices, ventilate the room and contact the dealer where you purchased the unit.

Do not use the system until a service person confirms that the portion where the refrigerant leaks is repaired.

13.2 After-sales service and warranty

13.2.1 Warranty period

- This product includes a warranty card that was filled in by the dealer at the time of installation. The completed card has to be checked by the customer and stored carefully.
- If repairs to the product are necessary within the warranty period, contact your dealer and keep the warranty card at hand.

13.2.2 Recommended maintenance and inspection

Since dust collects when using the unit for several years, performance of the unit will deteriorate to some extent. As taking apart and cleaning interiors of units requires technical expertise and in order to ensure the best possible maintenance of your units, we recommend to enter into a maintenance and inspection contract on top of normal maintenance activities. Our network of dealers has access to a permanent stock of essential components in order to keep your unit in operation as long as possible. Contact your dealer for more information.

When asking your dealer for an intervention, always state:

- The complete model name of the unit.
- The manufacturing number (stated on the nameplate of the unit).
- The installation date.
- The symptoms or malfunction, and details of the defect.



WARNING

- Do not modify, disassemble, remove, reinstall or repair the unit yourself as incorrect dismantling or installation may cause an electric shock or fire. Contact your dealer.
- In case of accidental refrigerant leaks, make sure there are no naked flames. The refrigerant itself is entirely safe, non-toxic and non-combustible, but it will generate toxic gas when it accidentally leaks into a room where combustible air from fan heaters, gas cookers, etc. is present. Always have qualified service personnel confirm that the point of leakage has been repaired or corrected before resuming operation.

14 Troubleshooting

If one of the following malfunctions occur, take the measures shown below and contact your dealer.



WARNING

Stop operation and shut off the power if anything unusual occurs (burning smells etc.).

Leaving the unit running under such circumstances may cause breakage, electric shock or fire. Contact your dealer.

The system must be repaired by a qualified service person:

If the system does not properly operate except for the above mentioned cases and none of the above mentioned malfunctions is evident, investigate the system according to the following procedures.

Malfunction	Measure
If the system does not operate at all.	<ul style="list-style-type: none"> • Check if there is no power failure. Wait until power is restored. If power failure occurs during operation, the system automatically restarts immediately after power is restored. • Check if no fuse has blown or breaker is activated. Change the fuse or reset the breaker if necessary.
If the system goes into fan only operation, but as soon as it goes into heating or cooling operation, the system stops.	<ul style="list-style-type: none"> • Check if air inlet or outlet of outdoor or indoor unit is not blocked by obstacles. Remove any obstacles and make sure the air can flow freely. • Check if the user interface display shows  (time to clean the air filter). (Refer to "13 Maintenance and service" on page 32 and "Maintenance" in the indoor unit manual.)

14 Troubleshooting

Malfunction	Measure
The system operates but cooling or heating is insufficient.	<ul style="list-style-type: none"> ▪ Check if air inlet or outlet of outdoor or indoor unit is not blocked by obstacles. Remove any obstacles and make sure the air can flow freely. ▪ Check if the air filter is not clogged (refer to "Maintenance" in the indoor unit manual). ▪ Check the temperature setting. ▪ Check the fan speed setting on your user interface. ▪ Check for open doors or windows. Close doors and windows to prevent wind from coming in. ▪ Check if there are too many occupants in the room during cooling operation. Check if the heat source of the room is excessive. ▪ Check if direct sunlight enters the room. Use curtains or blinds. ▪ Check if the air flow angle is proper.

If after checking all above items, it is impossible to fix the problem yourself, contact your installer and state the symptoms, the complete model name of the unit (with manufacturing number if possible) and the installation date (possibly listed on the warranty card).

14.1 Error codes: Overview

In case a malfunction code appears on the indoor unit user interface display, contact your installer and inform the malfunction code, the unit type, and serial number (you can find this information on the nameplate of the unit).

For your reference, a list with malfunction codes is provided. You can, depending on the level of the malfunction code, reset the code by pushing the ON/OFF button. If not, ask your installer for advice.

14.2 Symptoms that are NOT system malfunctions

The following symptoms are NOT system malfunctions:

14.2.1 Symptom: The system does not operate

- The air conditioner does not start immediately after the ON/OFF button on the user interface is pressed. If the operation lamp lights, the system is in normal condition. To prevent overloading of the compressor motor, the air conditioner starts 5 minutes after it is turned ON again in case it was turned OFF just before. The same starting delay occurs after the operation mode selector button was used.
- If "Under Centralized Control" is displayed on the user interface, pressing the operation button causes the display to blink for a few seconds. The blinking display indicates that the user interface cannot be used.
- The system does not start immediately after the power supply is turned on. Wait one minute until the micro computer is prepared for operation.

14.2.2 Symptom: Cool/Heat cannot be changed over

- When the display shows  (change-over under centralized control), it shows that this is a slave user interface.

- When the cool/heat changeover remote control switch is installed and the display shows  (change-over under centralized control), this is because cool/heat changeover is controlled by the cool/ heat changeover remote control switch. Ask your dealer where the remote control switch is installed.

14.2.3 Symptom: Fan operation is possible, but cooling and heating do not work

Immediately after the power is turned on. The micro computer is getting ready to operate and is performing a communication check with all indoor units. Please wait 12 minutes maximally until this process is finished.

14.2.4 Symptom: The fan strength does not correspond to the setting

The fan speed does not change even if the fan speed adjustment button is pressed. During heating operation, when the room temperature reaches the set temperature, the outdoor unit goes off and the indoor unit changes to whisper fan speed. This is to prevent cold air blowing directly on occupants of the room. The fan speed will not change even when another indoor unit is in heating operation, if the button is pressed.

14.2.5 Symptom: The fan direction does not correspond to the setting

The fan direction does not correspond with the user interface display. The fan direction does not swing. This is because the unit is being controlled by the micro computer.

14.2.6 Symptom: White mist comes out of a unit (Indoor unit)

- When humidity is high during cooling operation. If the interior of an indoor unit is extremely contaminated, the temperature distribution inside a room becomes uneven. It is necessary to clean the interior of the indoor unit. Ask your dealer for details on cleaning the unit. This operation requires a qualified service person.
- Immediately after the cooling operation stops and if the room temperature and humidity are low. This is because warm refrigerant gas flows back into the indoor unit and generates steam.

14.2.7 Symptom: White mist comes out of a unit (Indoor unit, outdoor unit)

When the system is changed over to heating operation after defrost operation. Moisture generated by defrost becomes steam and is exhausted.

14.2.8 Symptom: The user interface display reads "U4" or "U5" and stops, but then restarts after a few minutes

This is because the user interface is intercepting noise from electric appliances other than the air conditioner. The noise prevents communication between the units, causing them to stop. Operation automatically restarts when the noise ceases.

14.2.9 Symptom: Noise of air conditioners (Indoor unit)

- A "zeen" sound is heard immediately after the power supply is turned on. The electronic expansion valve inside an indoor unit starts working and makes the noise. Its volume will reduce in about one minute.

- A continuous low "shah" sound is heard when the system is in cooling operation or at a stop. When the drain pump (optional accessories) is in operation, this noise is heard.
- A "pishi-pishi" squeaking sound is heard when the system stops after heating operation. Expansion and contraction of plastic parts caused by temperature change make this noise.
- A low "sah", "choro-choro" sound is heard while the indoor unit is stopped. When another indoor unit is in operation, this noise is heard. In order to prevent oil and refrigerant from remaining in the system, a small amount of refrigerant is kept flowing.

14.2.10 Symptom: Noise of air conditioners (Indoor unit, outdoor unit)

- A continuous low hissing sound is heard when the system is in cooling or defrost operation. This is the sound of refrigerant gas flowing through both indoor and outdoor units.
- A hissing sound which is heard at the start or immediately after stopping operation or defrost operation. This is the noise of refrigerant caused by flow stop or flow change.

14.2.11 Symptom: Noise of air conditioners (Outdoor unit)

When the tone of operating noise changes. This noise is caused by the change of frequency.

14.2.12 Symptom: Dust comes out of the unit

When the unit is used for the first time in a long time. This is because dust has gotten into the unit.

14.2.13 Symptom: The units can give off odours

The unit can absorb the smell of rooms, furniture, cigarettes, etc., and then emit it again.

14.2.14 Symptom: The outdoor unit fan does not spin

During operation. The speed of the fan is controlled in order to optimise product operation.

14.2.15 Symptom: The display shows "88"

This is the case immediately after the main power supply switch is turned on and means that the user interface is in normal condition. This continues for 1 minute.

14.2.16 Symptom: The compressor in the outdoor unit does not stop after a short heating operation

This is to prevent refrigerant from remaining in the compressor. The unit will stop after 5 to 10 minutes.

14.2.17 Symptom: The inside of an outdoor unit is warm even when the unit has stopped

This is because the crankcase heater is warming the compressor so that the compressor can start smoothly.

14.2.18 Symptom: Hot air can be felt when the indoor unit is stopped

Several different indoor units are being run on the same system. When another unit is running, some refrigerant will still flow through the unit.

15 Relocation

Contact your dealer for removing and reinstalling the total unit. Moving units requires technical expertise.

16 Disposal

This unit uses hydrofluorocarbon. Contact your dealer when discarding this unit.



NOTICE

Do not try to dismantle the system yourself: the dismantling of the system, treatment of the refrigerant, oil and other parts must comply with applicable legislation. Units must be treated at a specialised treatment facility for reuse, recycling and recovery.

17 Glossary

Dealer

Sales distributor for the product.

Authorized installer

Technical skilled person who is qualified to install the product.

User

Person who is owner of the product and/or operates the product.

Applicable legislation

All international, European, national and local directives, laws, regulations and/or codes that are relevant and applicable for a certain product or domain.

Service company

Qualified company which can perform or coordinate the required service to the product.

Installation manual

Instruction manual specified for a certain product or application, explaining how to install, configure and maintain it.

Operation manual

Instruction manual specified for a certain product or application, explaining how to operate it.

Maintenance instructions

Instruction manual specified for a certain product or application, which explains (if relevant) how to install, configure, operate and/or maintain the product or application.

Accessories

Labels, manuals, information sheets and equipment that are delivered with the product and that need to be installed according to the instructions in the accompanying documentation.

Optional equipment

Equipment made or approved by Daikin that can be combined with the product according to the instructions in the accompanying documentation.

Field supply

Equipment not made by Daikin that can be combined with the product according to the instructions in the accompanying documentation.

ERC



4P452190-1 A 0000000Y

Copyright 2017 Daikin

DAIKIN EUROPE N.V.

Zandvoordestraat 300, B-8400 Oostende, Belgium

4P452190-1A 2017.04