

DAIKIN

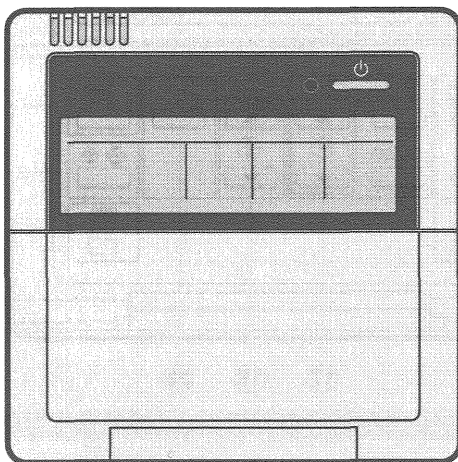

OPERATION MANUAL

VRV System air conditioner



Operation manual
VRV System air conditioner

English

RSXYP5KJY1
RSXYP8KJY1
RSXYP10KJY1
RSXYP16KJY1
RSXYP18KJY1
RSXYP20KJY1
RSXYP24KJY1
RSXYP26KJY1
RSXYP28KJY1
RSXYP30KJY1
RSEYP8KJY1
RSEYP10KJY1

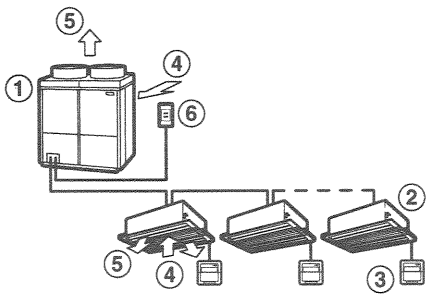

1 RSXY

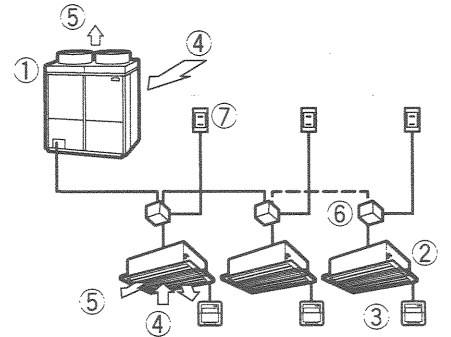

1 RSEY

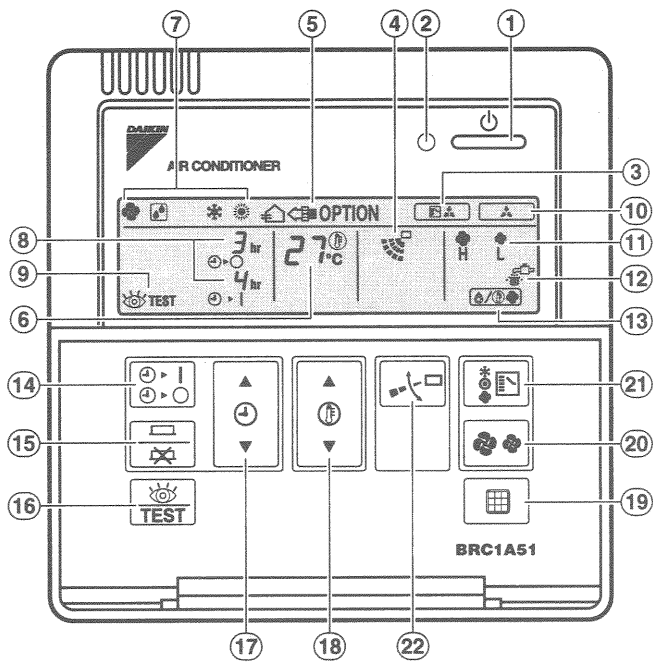

2

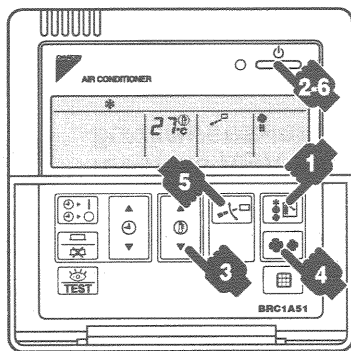
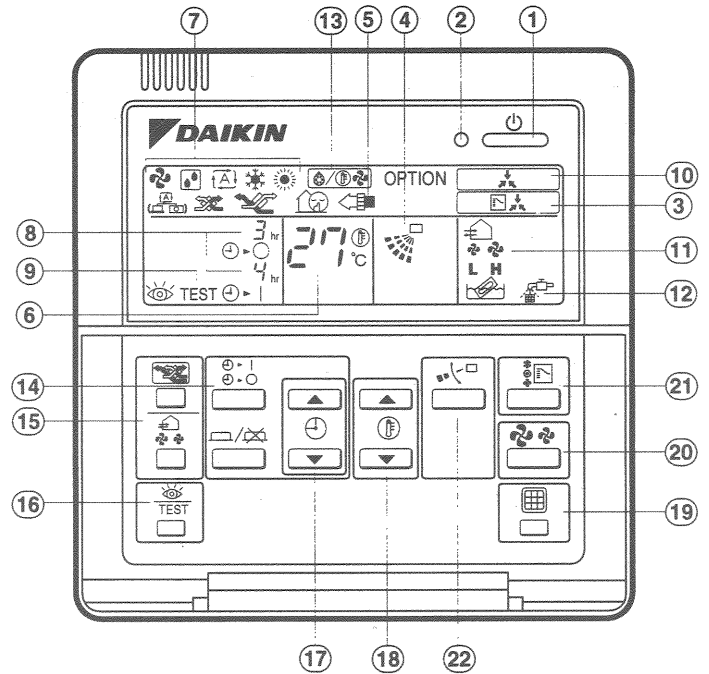

4

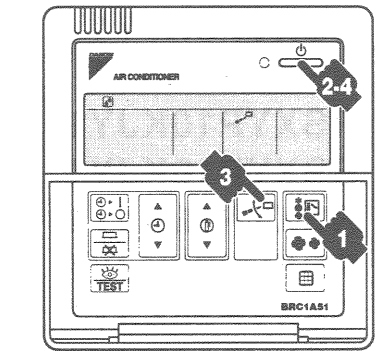
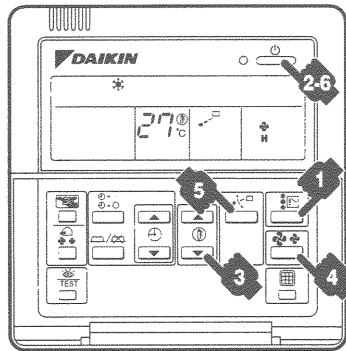

5

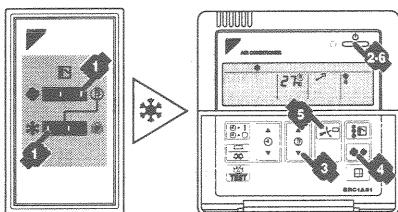

7.1

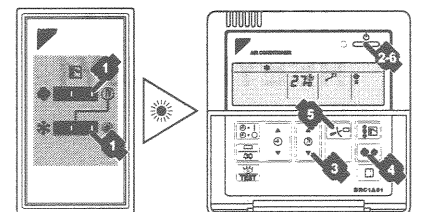
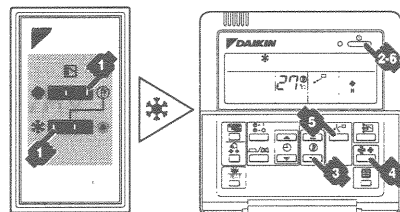

7.2

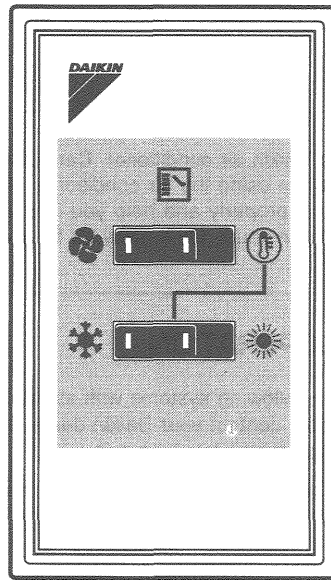

3

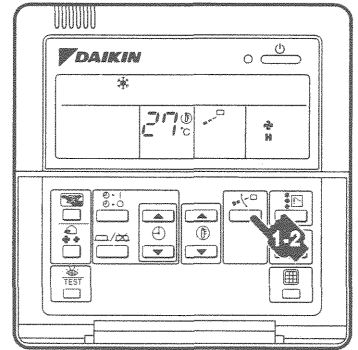
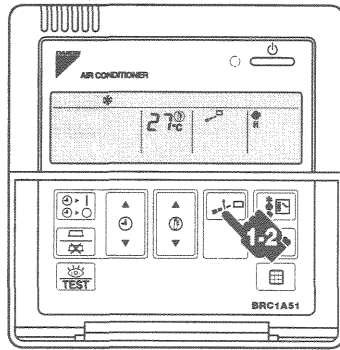
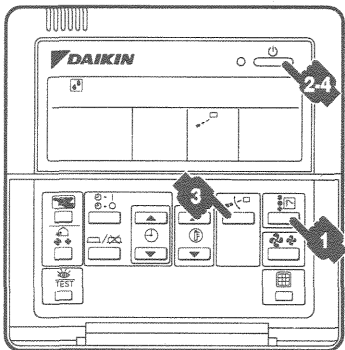

6

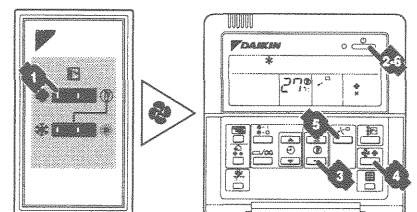
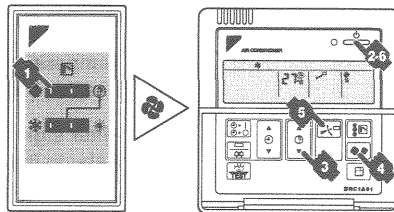
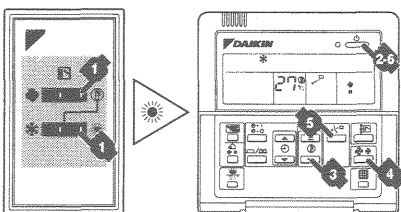

7.3

	page
What to do before operation	1
Name and function of remote controller switches and displays ..	1
Warning	2
Operation range	2
Operation procedure	2
Optimum operation	5
Following symptoms are not air conditioner troubles	5
Trouble shooting	6

Thank you for purchasing this Daikin air conditioner. Carefully read this operation manual before using the air conditioner. It will tell you how to use the unit properly and help you if any trouble occurs. After reading the manual, file it away for future reference.

WHAT TO DO BEFORE OPERATION

This operation manual is for the following systems with standard control. Before initiating operation, contact your Daikin dealer for the operation that corresponds to your system type and mark.

If your installation has a customized control system, ask your Daikin dealer for the operation that corresponds to your system.

Outdoor units (see figure 1)





	cool/heat changeover remote control switch	operation modes	
Inverter series			
heat pumps RSXY series	<input type="checkbox"/> yes <input type="checkbox"/> no		
Heat recovery series			
heat pumps RSEY series	<input type="checkbox"/> yes <input type="checkbox"/> no		

Names and functions of parts (see figure 1)

- 1 Outdoor unit
- 2 Indoor unit
- 3 Remote controller
- 4 Inlet air
- 5 Outlet air
- 6 BS (branch selector) unit
- 7 Cool/heat changeover remote control switch
(figure 1 shows systems with changeover remote control switches)

REMOTE CONTROLLER AND CHANGEOVER SWITCH: NAME AND FUNCTION OF EACH SWITCH AND DISPLAY (see figure 2 and 3)

- 1 On/off button**
Press the button and the system will start. Press the button again and the system will stop.
- 2 Operation lamp (red)**
The lamp lights up during operation.
- 3 Display (changeover under control)**
It is impossible to changeover heat/cool with the remote controller when this icon is displayed.
- 4 Display (air flow flap)**
Refer to the chapter 'Operation procedure - Adjusting the air flow direction'.
- 5 Display OPTION (ventilation/air cleaning)**
This display shows that the total heat exchange and the air cleaning unit are in operation. (these are optional accessories)
- 6 Display (set temperature)**
This display shows the temperature you have set.
- 7 Display (operation mode)**
This display shows the current operation mode.
- 8 Display (programmed time)**
This display shows the programmed time of the system start or stop.
- 9 Display TEST (inspection/test operation)**
When the inspection/test operation button is pressed, the display shows the mode in which the system actually is.
- 10 Display (under centralized control)**
When this display shows, the system is under centralized control. (This is not a standard specification.)
- 11 Display (fan speed)**
This display shows the fan speed you have selected.
- 12 Display (time to clean air filter)**
Refer to the indoor unit manual.
- 13 Display (defrost/hot start)**
Refer to the chapter 'Operation procedure - Explanation of heating operation.'
- 14 Timer mode start/stop button**
Refer to the chapter 'Operation procedure - Programming start and stop of the system with timer.'
- 15 Timer on/off button**
Refer to the chapter 'Operation procedure - Programming start and stop of the system with timer.'
- 16 Inspection/test operation button**
This button is only used by qualified service persons for maintenance purposes.
- 17 Programming time button**
Use this button for programming start and/or stop time.
- 18 Temperature setting button**
Use this button for setting the desired temperature.
- 19 Filter sign reset button**
Refer to the indoor unit manual.

- 20 Fan speed control button**
Press this button to select the fan speed of your preference.
- 21 Operation mode selector button**
Press this button to select the operation mode of your preference.
- 22 Air flow direction adjust button**
Refer to the chapter 'Operation procedure - Adjusting the air flow direction'.
- 23 Fan only/air conditioning selector switch**
Set the switch to  for fan only operation or to  for heating or cooling operation.
- 24 Cool/heat changeover switch**
Set the switch to  for cooling or to  for heating operation.

Note 

- In contradistinction to actual operating situations, the display on figure 1 shows all possible indications.
- If the filter sign lamp lights up, clean the air filter as explained in the indoor unit manual. After cleaning and reinstalling the air filter: press the filter sign reset button on the remote controller. The filter sign lamp on the display will go out.
- The remote controller BRC1A52 (for FXYS, FXYM, FXYL, FXYLM) does not have the display air flow flap (4) nor the air flow direction adjust button (22).

WARNING

NEVER DO THE FOLLOWING

- Never let the indoor unit or the remote controller get wet. Do not wash the outdoor unit with water.**
It may cause an electric shock or a fire.
- Never use flammable spray such as hair spray, lacquer or paint near the unit.**
It may cause a fire.
- Never touch the air outlet or the horizontal blades while the swing flap is in operation.**
Fingers may become caught or the unit may break down.
- Never replace a fuse with that of wrong ampere ratings or other wires when a fuse blows out.**
Use of wire or copper wire may cause the unit to break down or cause a fire.
- Never put any objects into the air inlet or outlet.**
Objects touching the fan at high operating speed can be dangerous.
- Never remove the fan guard of the outdoor unit.**
A fan rotating at high speed without the fan guard is very dangerous.
- Never press the button of the remote controller with a hard, pointed object.**
The remote controller may be damaged.
- Never pull or twist the electric wire of the remote controller.**
It may cause the unit to malfunction.
- Never inspect or service the unit by yourself.**
Ask a qualified service person to perform this work.
- To prevent refrigerant leak, contact your Daikin dealer.**
When the system is installed and run in a small room, it is required to keep the concentration of the refrigerant, if by and chance coming out, below the limit. Otherwise, oxygen in the room may be affected, resulting in a serious accident.
- Cut off all electric waves before servicing.**

OPERATION RANGE

Use the system in the following temperature and humidity ranges for safe and effective operation.

	COOLING	HEATING
outdoor temperature	-5°~ 43°CDB	-13.7°~ 21°CDB -15°~ 15.5°CWB
indoor temperature	21°~ 32°CDB 15.5°~ 25°CWB	15°~ 27°CDB
indoor humidity	≤ 80%*	



*to avoid condensation and water dripping out the unit

If the temperature or the humidity is beyond these conditions, safety devices may work and the air conditioner may not operate.

OPERATION PROCEDURE





- Operation procedure varies according to the combination of outdoor unit and remote controller. Read the chapter 'What to do before operation'.
- To protect the unit, turn on the main power switch 6 hours before operation.
- If the main power supply is turned off during operation, operation will restart automatically after the power turns back on again.

COOLING, HEATING, AUTOMATIC, AND FAN ONLY OPERATION (see figure 4 and 7)

- Changeover cannot be made with a remote controller whose display shows  (changeover under control).
- When the display  flashes, refer to the chapter 'Operation procedure - Setting the master remote controller'.
- Automatic operation can be selected only by RSEY series.
- The fan may keep on running for about 1 minute after the heating operation stops.
- The air flow rate may adjust itself depending on the room temperature or the fan may stop immediately. This is not a malfunction.

FOR SYSTEMS WITHOUT COOL/HEAT CHANGEVER REMOTE CONTROL SWITCH (see figure 4)

 Press the operation mode selector button several times and select the operation mode of your choice;

-  Cooling operation
-  Heating operation
-  Automatic operation
-  Fan only operation



Note

- Automatic operation (RSEY only)
In this operation mode, cool/heat changeover is automatically conducted.

 Press the on/off button.
The operation lamp lights up and the system starts operation.

FOR SYSTEMS WITH COOL/HEAT CHANGEVER REMOTE CONTROL SWITCH (see figure 7)

 Select operation mode with the cool/heat changeover remote control switch as follows:

-  Cooling operation (see figure 7.1)
-  Heating operation (see figure 7.2)
-  Fan only operation (see figure 7.3)

 Press the on/off button.
The operation lamp lights up and the system starts operation.

Adjustment

For programming temperature, fan speed and air flow direction (only for the remote controller BRC1A51: FXYC, FXYF, FXYH, FXYK, FXYA), follow the procedure shown below.

 Press the temperature setting button and program the desired temperature.

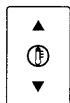

Each time this button is pressed, the temperature setting rises or lowers 1°C.

Note

- Set the temperature within the operation range.
- The temperature setting is impossible for fan only operation.

 Press the fan speed control button and select the fan speed of your preference.

 Press air flow direction adjust button.
Refer to the chapter 'Adjusting the air flow direction' for details.

Stopping the system

 Press the on/off button once again.
The operation lamp goes off and the system stops operation.

Note

- Do not turn off power immediately after the unit stops, but wait for at least 5 minutes.

EXPLANATION OF HEATING OPERATION

Defrost operation

- In heating operation, freezing of the outdoor unit coil increases. Heating capability decreases and the system goes into defrost operation.
- The indoor unit fan stops and the remote controller displays .
- After maximum 10 minutes of defrost operation, the system returns to heating operation again.



Hot start

- In order to prevent cold air from blowing out of an indoor unit at the start of heating operation, the indoor fan is automatically stopped. The display of the remote controller shows .

PROGRAM DRY OPERATION

- The function of this program is to decrease the humidity in your room with a minimum temperature decrease.
- The micro computer automatically determines temperature and fan speed.
- The system does not go into operation if the room temperature is low.

FOR SYSTEMS WITHOUT COOL/HEAT CHANGEVER REMOTE CONTROL SWITCH (see figure 5)

 Press the operation mode selector button several times and select  (program dry operation)

 Press the on/off button
The operation lamp lights up and the system starts operation.

 Press the air flow direction adjust button (only for FXYC, FXYF, FXYH, FXYK, FXYA). Refer to the chapter 'Adjusting the air flow direction' for details.

Stopping the system



 Press the on/off button once again.
The operation lamp goes off and the system stops operation.

Note

- Do not turn off power immediately after the unit stops, but wait for at least 5 minutes.

FOR SYSTEMS WITH COOL/HEAT CHANGEVER REMOTE CONTROL SWITCH (see figure 8)

 Select cooling operation mode with the cool/heat changeover remote control switch.

 Press the operation mode selector button several times and select program dry .

 Press the on/off button
The operation lamp lights up and the system starts operation.

 Press the air flow direction adjust button (only for FXYC, FXYF, FXYH, FXYK, FXYA). Refer to the chapter 'Adjusting the air flow direction' for details.

Stopping the system

 Press the on/off button once again.
The operation lamp goes off and the system stops operation.

Note

- Do not turn off power immediately after the unit stops, but wait for at least 5 minutes.

ADJUSTING THE AIR FLOW DIRECTION (see figure 6) (only for Double-flow, Multi-flow, Corner, Ceiling-suspended and Wall-mounted)

 Press the air flow direction button to select the air direction.
The air flow flap display swings as shown below and the air flow direction continuously varies. (Automatic swing setting)



 Press the air flow direction adjust button to select the air direction of your choice.





The air flow flap display stops swinging and the air flow direction is fixed. (Fixed air flow direction setting)

MOVEMENT OF THE AIR FLOW FLAP (see figure 13)

For the following conditions, a micro computer controls the air flow direction which may be different from the display.

COOLING	HEATING
<ul style="list-style-type: none"> When operating continuously at horizontal air flow direction When continuous operation with downward air flow is performed at the time of cooling with a ceiling-suspended or a wall-mounted unit, the microcomputer may control the flow direction, and then the remote control indication also will change. 	<ul style="list-style-type: none"> When the room temperature is lower than the set temperature At defrost operation





The air flow direction can be adjusted in one of the following ways.

- The air flow flap itself adjusts its position.
- The air flow direction can be fixed by the user.
- Automatic  and desired position .





Note

- The movable limit of the flap is changeable. Contact your Daikin dealer for details. (only for Double-flow, Multi-flow, Corner, Ceiling-suspended and Wall-mounted)
- Avoid operating in the horizontal direction . It may cause dew or dust to settle on the ceiling.

PROGRAMMING START AND STOP OF THE SYSTEM WITH TIMER (see figure 9)





- The timer is operated in the following two ways.
Programming the stop time  . The system stops operating after the set time has elapsed.
Programming the start time  . The system starts operating after the set time has elapsed.
- The timer can be programmed for a maximum of 72 hours.
- The start and the stop time can be simultaneously programmed.

 Press the timer mode start/stop button several times and select the mode on the display.
The display flashes.



- For setting the timer stop  
- For setting the timer start  

 Press the programming time button and set the time for stopping or starting the system

 Each time this button is pressed, the time advances or goes backward by 1 hour.

 Press the timer on/off button.
The timer setting procedure ends. The display   or   changes from flashing light to constant light.

Note

- When setting the timer off and on at the same time, repeat the above procedure (from  to ) once again.
- After the timer is programmed, the display shows the remaining time.
- Press the timer on/off button once again to cancel programming. The display vanishes.

For example: (see figure 11)

When the timer is programmed to stop the system after 3 hours and start the system after 4 hours, the system will stop after 3 hours and start 1 hour later.

SETTING THE MASTER REMOTE CONTROLLER (for RSXY and RSEY series) (see figure 10)

- When the system is installed as shown in figure 14 and 15, it is necessary to designate one of the remote controllers as the master remote controller.

FOR RSXY SERIES (see figure 14)



When one outdoor unit is connected with several indoor units.



FOR RSEY SERIES (see figure 15)

When one BS unit is connected with several indoor units.

- Only the master remote controller can select heating, cooling or automatic (only RSEY series) operation.
- The displays of slave remote controllers show  (changeover under control) and they automatically follow the operation mode directed by the master remote controller. However, it is possible to changeover to program dry with slave remote controllers if the system is in cooling operation set by the master remote controller.

How to designate the master remote controller

 Press the operation mode selector button of the current master remote controller for 4 seconds.
The display showing  (changeover under control) of all slave remote controllers connected to the same outdoor unit or BS unit flashes.

 Press the operation mode selector button of the controller that you wish to designate as the master remote controller. Then designation is completed. This remote controller is designated as the master remote controller and the display showing  (changeover under control) vanishes. The displays of other remote controllers show  (changeover under control).

PRECAUTIONS FOR GROUP CONTROL SYSTEM OR TWO REMOTE CONTROLLER CONTROL SYSTEM

This system provides two other control systems beside individual control (one remote controller controls one indoor unit) system. Confirm the following if your unit is of the following control system type.

- Group control system**
One remote controller controls up to 16 indoor units. All indoor units are equally set.
- Two remote controller control system**
Two remote controllers control one indoor unit (in case of group control system, one group of indoor units). The unit is individually operated.

Note

- Contact your Daikin dealer in case of changing the combination or setting of group control and two remote controller control systems.

OPTIMUM OPERATION

Observe the following precautions to ensure the system operates properly.



- Adjust the air outlet properly and avoid direct air flow to room inhabitants.
- Adjust the room temperature properly for a comfortable environment. Avoid excessive heating or cooling.
- Prevent direct sunlight from entering a room during cooling operation by using curtains or blinds.
- Keep doors and windows closed. If the doors and windows remain open, air will flow out of your room causing a decrease in the cooling or heating effect.
- Never place objects near the air inlet or the air outlet of the unit. It may cause deterioration in the effect or stop the operation.
- Turn off the main power supply switch to the unit when the unit is not used for longer periods of time. If the switch is on, it uses electricity. Before restarting the unit, turn on the main power supply switch 6 hours before operation to ensure smooth running. (Refer to the chapter 'Maintenance' in the indoor unit manual)
- When the display shows  (time to clean the air filter), ask a qualified service person to clean the filters. (Refer to the chapter 'Maintenance' in the indoor unit manual)

FOLLOWING SYMPTOMS ARE NOT AIR CONDITIONER TROUBLES

THE SYSTEM DOES NOT OPERATE

- **The air conditioner does not start immediately after the ON/OFF button on the remote controller is pushed.**
If the operation lamp lights, the system is in normal condition. To prevent overloading of the compressor motor, the air conditioner starts 5 minutes after it is turned ON again in case it was turned OFF just before. The same starting delay occurs after the operation mode selector button was used.
- **The system does not start immediately after the power supply is turned on.**
Wait one minute until the micro computer is prepared for operation.

COOL/HEAT CANNOT BE CHANGED OVER

- When the display shows  (changeover under control), it shows that this is a slave remote controller.
- When the cool/heat changeover remote control switch is installed and the display shows  (changeover under control).
This is because cool/heat changeover is controlled by the cool/heat changeover remote control switch. Ask your Daikin dealer where the remote control switch is installed.

WHITE MIST COMES OUT OF A UNIT

Indoor unit

- **When humidity is high during cooling operation**
If the interior of an indoor unit is extremely contaminated, the temperature distribution inside a room becomes uneven. It is necessary to clean the interior of the indoor unit. Ask your Daikin dealer for details on cleaning the unit. This operation requires a qualified service person.
- **Immediately after the cooling operation stops and if the room temperature and humidity are low**
This is because warm refrigerant gas flows back into the indoor unit and generates steam.

Indoor unit, outdoor unit

- **When the system is changed over to heating operation after defrost operation**
Moisture generated by defrost becomes steam and is exhausted.

NOISE OF AIR CONDITIONERS

Indoor unit

- **A 'zeen' sound is heard immediately after the power supply is turned on.**
The electronic expansion valve inside an indoor unit starts working and makes the noise. Its volume will reduce in about one minute.
- **A continuous low 'shah' sound is heard when the system is in cooling operation or at a stop**
When the drain pump (optional accessories) is in operation, this noise is heard.
- **A 'pishi-pishi' squeaking sound is heard when the system stops after heating operation.**
Expansion and contraction of plastic parts caused by temperature change make this noise.
- **A low 'sah', 'choro-choro' sound is heard while the indoor unit is stopped.**
When the other indoor unit is in operation, this noise is heard. In order to prevent oil and refrigerant from remaining in the system, a small amount of refrigerant is kept flowing.

Indoor unit, outdoor unit

- **A continuous low hissing sound is heard when the system is in cooling or defrost operation.**
This is the sound of refrigerant gas flowing through both indoor and outdoor units.
- **A hissing sound which is heard at the start or immediately after stopping operation or defrost operation**
This is the noise of refrigerant caused by flow stop or flow change.

Outdoor unit

- **When the tone of operating noise changes**
This noise is caused by the change of frequency.

THE UNITS CAN GIVE OFF ODOURS

- The unit can absorb the smell of rooms, furniture, cigarettes, etc., and then emit it again.

THE DISPLAY SHOWS *88*.

- This is the case immediately after the main power supply switch is turned on and means that the remote controller is in normal condition. This continues for one minute.

THE COMPRESSOR IN THE OUTDOOR UNIT DOES NOT STOP AFTER A SHORT HEATING OPERATION

- This is to prevent oil and refrigerant from remaining in the compressor. The unit will stop after 5 to 10 minutes.

THE INSIDE OF AN OUTDOOR UNIT IS WARM EVEN WHEN THE UNIT HAS STOPPED

- This is because the crankcase heater is warming the compressor so that the compressor can start smoothly.

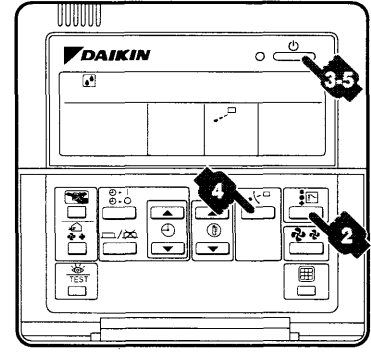
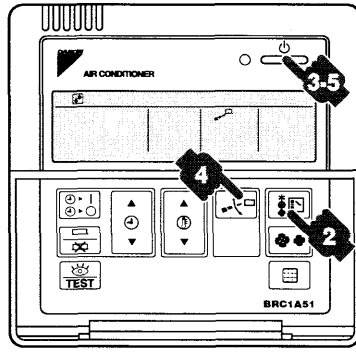
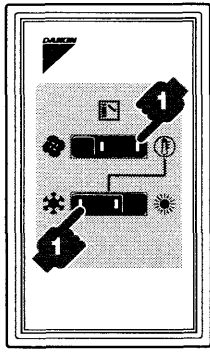

8

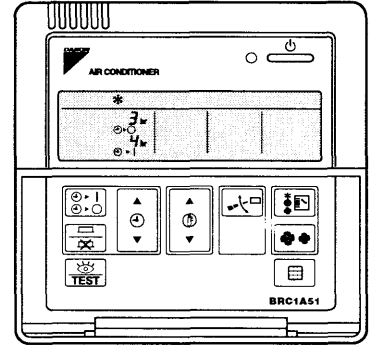
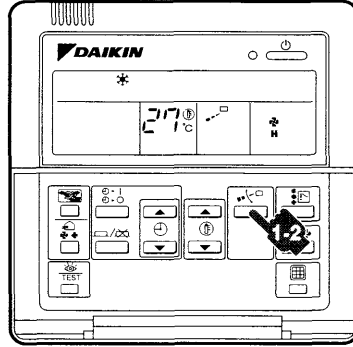
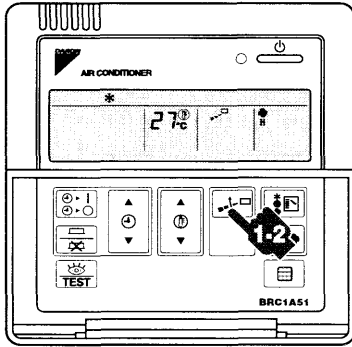

10

11

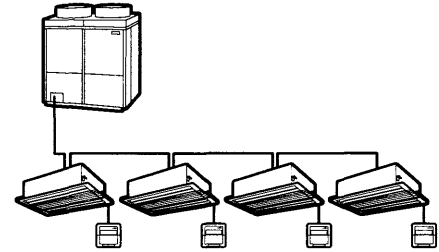
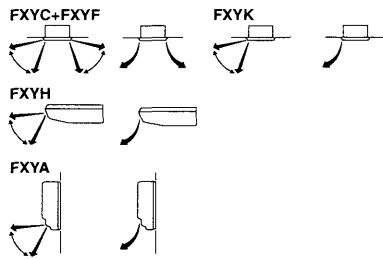

13

14

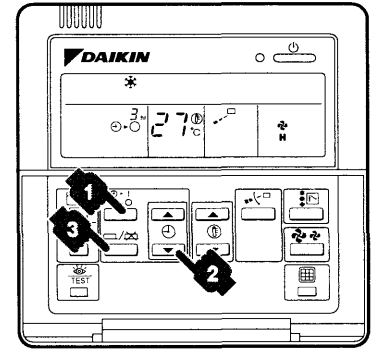
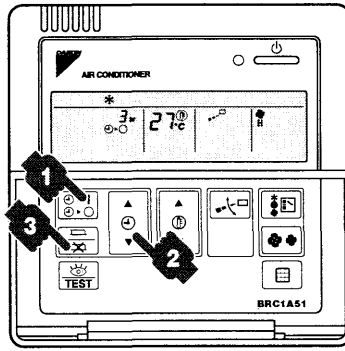

9

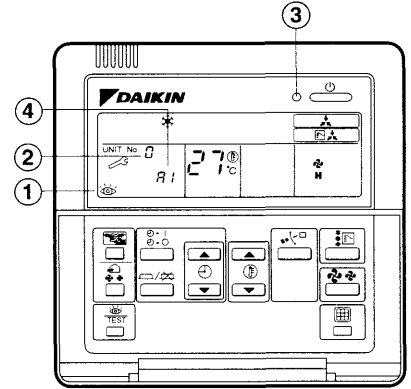
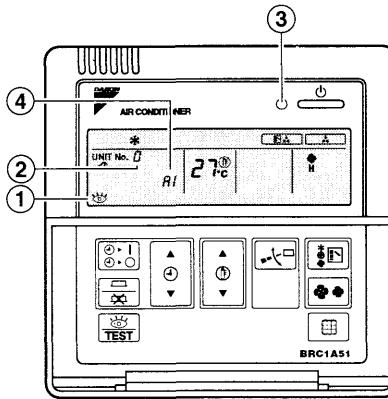
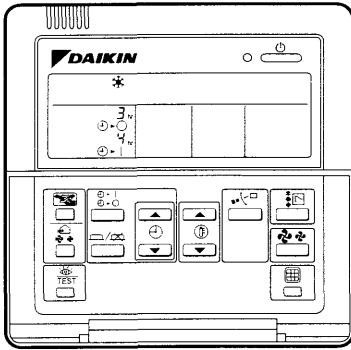

12

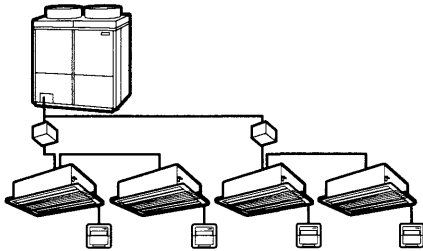

15

DAIKIN INDUSTRIES, LTD.

Head office:
Umeda Center Bldg., 4-12, Nakazaki-Nishi 2 chome,
Kita-ku, Osaka, 530-8323 Japan

Tokyo office:
Shinjuku Sumitomo Bldg., 6-1 Nishi-Shinjuku
2-chome, Shinjuku-ku, Tokyo, 163-0290 Japan

DAIKIN EUROPE NV

Zandvoordestraat 300, B-8400 Oostende, Belgium