



Air Conditioning
Technical Data

RXYSCQ-TV1



- > RXYSCQ4TMV1B
- > RXYSCQ5TMV1B

TABLE OF CONTENTS

RXYSCQ-TV1

1	Features	2
2	Specifications	3
	Technical Specifications	3
	Electrical Specifications	4
3	Options	6
4	Combination table	7
5	Capacity tables	9
	Capacity Table Legend	9
	Integrated Heating Capacity Correction Factor	10
	Capacity Correction Factor	11
6	Dimensional drawings	12
7	Centre of gravity	13
8	Piping diagrams	14
9	Wiring diagrams	15
	Wiring Diagrams - Single Phase	15
10	External connection diagrams	16
11	Sound data	17
	Sound Power Spectrum	17
	Sound Pressure Spectrum	18
12	Installation	19
	Installation Method	19
	Refrigerant Pipe Selection	21
13	Operation range	23

1 Features

The most compact VRV

- Compact & lightweight single fan design makes the unit almost unnoticeable
- Covers all thermal needs of a building via a single point of contact: accurate temperature control, ventilation, air handling units and Biddle air curtains
- Wide range of indoor units: either connect VRV or stylish indoor units such as Daikin Emura, Nexura ...
- Incorporates VRV IV standards & technologies: Variable Refrigerant Temperature and full inverter compressors
- Customize your VRV for best seasonal efficiency & comfort with the weather dependant Variable Refrigerant Temperature function. Increased seasonal efficiency with up to 28%. No more cold draft by supply of high outblow temperatures
- VRV configurator software for the fastest and most accurate commissioning, configuration and customisation
- 3 steps in night quiet mode: step 1: 47dBA, step 2: 44 dBA, step 3: 41 dBA
- Possibility to limit peak power consumption between 30 and 80%, for example during periods with high power demand
- Connectable to all VRV control systems
- Keep your system in top condition via our i-Net service: 24/7 monitoring for maximum efficiency, extended lifetime, immediate service support thanks to failure prediction and a clear understanding of operability and usage



Inverter

2 Specifications

2-1 Technical Specifications					RXYSCQ4TV1	RXYSCQ5TV1
Capacity range			HP	4	5	
Cooling capacity	Nom.	35°CDB		kW	12.1 (1)	14.0 (1)
Heating capacity	Nom.	6°CWB		kW	12.1 (2)	14.0 (2)
	Max.	6°CWB		kW	14.2 (2)	16.0 (2)
Power input - 50Hz	Cooling	Nom.	35°CDB	kW	3.43 (1)	4.26 (1)
		Heating	Nom.	6°CWB	kW	3.18 (2)
		Max.	6°CWB	kW	4.14 (2)	5.00 (2)
Capacity control	Method				Inverter controlled	
EER at nom. capacity	35°C AHRI			kW/kW	3.53 (1)	3.29 (1)
	35°CDB			kW/kW	-	-
ESEER - Automatic					6.93	6.57
ESEER - Standard					5.44	5.07
COP at nom. capacity	6°CWB			kW/kW	3.81 (2)	3.58 (2)
COP at max. capacity	6°CWB			kW/kW	3.43 (2)	3.20 (2)
Dimensions	Unit	Height	mm	823		
		Width	mm	940		
		Depth	mm	460		
	Packed unit	Height	mm	995		
		Width	mm	1,030		
		Depth	mm	580		
Maximum number of connectable indoor units					64	
Indoor index connection	Min.				50	62.5
	Nom.					-
	Max.				130	162.5
Weight	Unit		kg	94		
	Packed unit		kg	106		
Packing	Material			Carton		
	Weight		kg	3.8		
Packing 2	Material			Wood		
	Weight		kg	5.8		
Packing 3	Material			Plastic		
	Weight		kg	1.1		
Casing	Colour			Daikin White		
	Material			Painted galvanized steel plate		
Heat exchanger	Type				Cross fin coil	
	Fin	Treatment			Anti-corrosion treatment	
Compressor	Quantity			1		
	Type			Hermetically sealed swing compressor		
	Crankcase heater		W	33		
Fan	Quantity			1		
	Air flow rate	Cooling	Nom.	m ³ /min	91	
	External static pressure	Max.		Pa	-	
	Discharge direction				Horizontal	
	Type				Propeller fan	
Fan motor	Quantity			1		
	Output		W	200		
	Model			Brushless DC motor		
Sound power level	Cooling	Nom.	dBA	68 (3)	69 (3)	
Sound pressure level	Cooling	Nom.	dBA	51 (4)	52 (4)	
Operation range	Cooling	Min.~Max.		°CDB	-5~46	
	Heating	Min.~Max.		°CWB	-20~15.5	
Refrigerant	Type			R-410A		
	GWP			2,087.5		
	Charge		TCO ₂ eq	7.7		
			kg	3.7		
Refrigerant oil	Type			Synthetic (ether) oil FVC50K		
	Charged volume		l	1.4		

2 Specifications

2

2-1 Technical Specifications					RXYSCQ4TV1	RXYSCQ5TV1
Piping connections	Liquid	Type			Flare connection	
		OD	mm		9.52	
	Gas	Type			Flare connection	
		OD	mm		15.9	
	Total piping length	System	Actual	m	-	
	Level difference	OU - IU	Outdoor unit in highest position	m	-	
			Indoor unit in highest position	m	-	
Heat insulation					Both liquid and gas pipes	
Piping length	OU - IU	Max.	m	300		
Defrost method					Reversed cycle	
Safety devices	Item	01			High pressure switch	
		02			Fan driver overload protector	
		03			Inverter overload protector	
		04			PC board fuse	
PED	Category				Category I	
	Most critical part	Name			Compressor	
		Ps*V	Bar*l		167	

Standard Accessories : Installation manual;

Standard Accessories : Operation manual;

Standard Accessories : Connection pipes;

2-2 Electrical Specifications					RXYSCQ4TV1	RXYSCQ5TV1
Power supply	Name				V1	
	Phase				1~	
	Frequency			Hz	50	
	Voltage			V	220-240	
Voltage range	Min.			%	-10	
	Max.			%	10	
Current	Nominal running current (RLA) - 50Hz	Cooling	A	19.0 (5)		
Current - 50Hz	Minimum circuit amps (MCA)			A	29.1	
	Maximum fuse amps (MFA)			A	32	
	Total overcurrent amps (TOCA)			A	29.1 (6)	
	Full load amps (FLA)		Total	A	0.6	
Wiring connections - 50Hz	For power supply	Quantity			3G	
	For connection with indoor	Quantity			2	
		Remark			F1,F2	
Power supply intake					Both indoor and outdoor unit	

2 Specifications

Notes

(1) Nominal cooling capacities are based on: indoor temperature: 27°CDB, 19°CWB, outdoor temperature: 35°CDB, equivalent refrigerant piping: 5m, level difference: 0m. Data for standard efficiency series. Eurovent 2015 tolerances are used.

(2) Nominal heating capacities are based on: indoor temperature: 20°CDB, outdoor temperature: 7°CDB, 6°CWB, equivalent refrigerant piping: 5m, level difference: 0m. Data for standard efficiency series. Eurovent 2015 tolerances are used.

(3) Sound power level is an absolute value that a sound source generates.

(4) Sound pressure level is a relative value, depending on the distance and acoustic environment. For more details, please refer to the sound level drawings.

(5) RLA is based on following conditions: indoor temp. 27°CDB, 19°CWB; outdoor temp. 35°CDB

(6) TOCA means the total value of each OC set.

Actual number of units depends on the indoor unit type (VRV DX indoor, RA DX indoor, etc.) and the connection ratio restriction for the system (being: $50\% \leq CR \leq 130\%$).

Sound values are measured in a semi-anechoic room.

For detailed contents of standard accessories, see installation/operation manual

MSC means the maximum current during start up of the compressor. VRV IV uses only inverter compressors. Starting current is always \leq max. running current.

MCA must be used to select the correct field wiring size. The MCA can be regarded as the maximum running current.

MFA is used to select the circuit breaker and the ground fault circuit interrupter (earth leakage circuit breaker).

FLA means the nominal running current of the fan

Voltage range: units are suitable for use on electrical systems where voltage supplied to unit terminal is not below or above listed range limits.

Maximum allowable voltage range variation between phases is 2%.

In accordance with EN/IEC 61000-3-11, respectively EN/IEC 61000-3-12, it may be necessary to consult the distribution network operator to ensure that the equipment is connected only to a supply with $Z_{sys} \leq Z_{max}$, respectively $S_{sc} \geq$ minimum S_{sc} value.

EN/IEC 61000-3-11: European/international technical standard setting the limits for voltage changes, voltage fluctuations and flicker in public low-voltage supply systems for equipment with rated $\leq 75A$

EN/IEC 61000-3-12: European/international technical standard setting the limits for harmonic currents produced by equipment connected to public low-voltage system with input current $> 16A$ and $\leq 75A$ per phase

S_{sc} : Short-circuit power

Z_{sys} : system impedance

The standard ESEER value corresponds with normal VRV IV-S heat pump operation, not taking into account the advanced energy saving functionality.

The automatic ESEER value corresponds with normal VRV IV-S heat pump operation, including the advanced energy saving functionality (variable refrigerant temperature control).

3 Options

3 - 1 Options

3

RXYSCQ-TV1
 RXYSQ-TV1
 RXYSQ-TY1

Nr.	Item	RXYSCQ4~5TMV1B	RXYSQ4~6T7V1B	RXYSQ4~6T7Y1B	RXYSQ8~12TMY1B	RXYSQ6T7Y1B9
I.	Refnet header	KHRQ22M29H				
		-	-	-	KHRQ22M64H	-
II.	Refnet joint	KHRQ22M20T				
		-	-	-	KHRQ22M29T9	-
		-	-	-	KHRQ22M64T	-
Ia.	Cool/heat selector (switch)	-	KRC19-26		-	KRC19-26
Ib.	Cool/heat selector (fixing box)	-	KJB111A		-	KJB111A
Ic.	Cool/heat selector (PCB)	-	EBRP2B	-	-	-
Id.	Cool/heat selector (cable)	-	-	EKCHSC	-	EKCHSC
2.	Drain plug kit	-	EKDK04		-	EKDK04
3.	VRV configurator	EKPCAB*				
4.	Demand PCB	DTA104A61/62*				
5.	Branch provider - 2 rooms	BPMKS967A2				-
6.	Branch provider - 3 rooms	BPMKS967A3				-

Notes

1. All options are kits
2. To mount option 1a, option 1b is required.
3. For RXYSQ4~6T7Y1B
To operate the cool/heat selector function, options 1a and 1c are both required.
4. For RXYSQ4~6T7Y1B
To operate the cool/heat selector function, options 1a and 1d are both required.

3D097778A

4 Combination table

4 - 1 Combination Table

RXYSCQ-TV1
RXYSQ-TV1
RXYSQ-TY1

Indoor unit combination pattern	VRV* DX box + indoor unit	RA DX box + indoor unit	Hydrobox unit	Air handling unit (AHU) ⁽¹⁾
VRV* DX box + indoor unit	O	X	X	O
RA DX box + indoor unit	X	O	X	X
Hydrobox unit ⁽¹⁾	X	X	X	X
Air handling unit (AHU)	O ₁	X	X	O ₁

O: Allowed
 X: Not allowed

Notes

- O₁
 - Combination of AHU only + control box EKEQFA (not combined with VRV DX indoor units)
 - X-control is possible (up to 3x [EKEV+EKEQFA* boxes] can be connected to one outdoor unit (system)). No Variable Refrigerant Temperature control possible.
 - Y-control is possible (up to 3x [EKEV+EKEQFA* boxes] can be connected to one outdoor unit (system)). No Variable Refrigerant Temperature control possible.
 - W-control is possible (up to 3x [EKEV+EKEQFA* boxes] can be connected to one outdoor unit (system)). No Variable Refrigerant Temperature control possible.
 - Combination of AHU only + control box EKEQMA (not combined with VRV DX indoor units)
 - Z-control is possible (the allowed number of [EKEV + EKEQMA boxes] is determined by the connection ratio (90-110%) and the capacity of the outdoor unit.
- Combination of AHU and VRV DX indoor units
 - Z-control is possible [EKEQMA* boxes are allowed, but with a limited connection ratio].
- ⁽¹⁾ The following units are considered AHUs:
 - EKEV + EKEQ(MA/FA) + AHU coil
 - Biddle air curtain
 - FXMQ_MF units

Information

→ VRM units are considered to be regular VRV DX indoor units.

3D097983

RXYSCQ-TV1
RXYSQ-TV1
RXYSQ-TY1

Combination table	RXYSCQ4*5TMV1B	RXYSQ4*6T7V1B	RXYSQ4*6T7Y1B	RXYSQ8*12TMY1B
VRV* DX box + indoor unit	O	O	O	O
RA DX box + indoor unit	O	O	O	O
Hydrobox unit	X	X	X	X
Air handling unit (AHU) ⁽²⁾	O	O	O	O

O: Allowed
 X: Not allowed

Notes

- ⁽²⁾ The following units are considered AHUs:
 - EKEV + EKEQ(MA/FA) + AHU coil
 - Biddle air curtain
 - FXMQ_MF units

3D097983

4 Combination table

4 - 1 Combination Table

4

RYSCQ-TV1
RXYSQ-TV1_TY1

VRV4-S
Heat pump
RA/SA DX indoor unit
Compatibility list

Configuration		Indoor unit type	
RA indoor unit	Wall-mounted	Emura	FTXG20L (W/S)
			FTXG25L (W/S)
			FTXG35L (W/S)
			FTXG50L (W/S)
		FTXS	FTXS20K
			FTXS25K
			FTXS35K
			FTXS42K
			FTXS50K
			FTXS60G
			FTXS71G
			CTXS15K
			CTXS35K
			Flex
	FLXS35B		
	Ceiling-mounted	FLXS50B	
		FLXS60B	
		FVXS	FVXS25F
			FVXS35F
	FVXS50F		
	Nexura		FVXG25K
			FVXG35K
			FVXG50K
	FNQ	FNQ25A	
		FNQ35A	
		FNQ50A	
		FNQ60A	
	Duct	FDXS	FDXS25F
FDXS30F			
FDXS50F9			
FDXS60F			

Configuration		Indoor unit type
SA indoor unit	Cassette	Fully Flat 2x2
		FFQ25C
		FFQ35C
		FFQ50C
		FFQ60C
		Roundflow 3x3
	FCQG35F	
	FCQG50F	
	FCQG60F	
	FCQG71F	
	Ceiling-suspended	FHQ35C
		FHQ50C
		FHQ60C
		FHQ71C
Duct	FBQ35D	
	FBQ50D	
	FBQ60D	
	FBQ71D	

Remark

1. The limitations on the use of RA/SA indoor units with the VRV4-S Heat Pump are subject to the rules set out in drawings 3D097983 and 3D097984.

3D09777A

5 Capacity tables

5 - 1 Capacity Table Legend

In order to fulfill more your requirements on quick access of data in the format you require, we have developed a tool to consult capacity tables.

Below you can find the link to the capacity table database and an overview of all the tools we have to help you select the correct product:

- Capacity table database: lets you find back and export quickly the capacity information you are looking for based upon unit model, refrigerant temperature and connection ratio.
→ webtools.daikin.eu

- E-data app: gives a complete overview of the Daikin products available in your country, with all engineering data and commercial info in your own language. Download the app now!
→ <https://itunes.apple.com/us/app/daikin-e-data/id565955746?mt=8>



- Selection software: allows you to do load calculations, equipment selections and energy simulations for our VRV, Daikin Altherma, refrigeration and applied systems products.
→ my.daikin.eu



5 Capacity tables

5 - 2 Integrated Heating Capacity Correction Factor

5

RXYSCQ-TV1
 RXYSQ-TV1
 RXYSQ-TV1

Integrated heating capacity coefficient

The heating capacity tables do not take into account the capacity reduction in case of frost accumulation or defrost operation. The capacity values that take these factors into account, or in other words, the integrated heating capacity values, can be calculated as follows:

Formula

- A = Integrated heating capacity
- B = Capacity characteristics value
- C = Integrated correction factor for frost accumulation (see table)

$$A = B * C$$

Inlet air temperature of heat exchanger

[°CDB/°CWB]	-7/-7.6	-5/-5.6	-3/-3.7	0/-0.7	3/2.2	5/4.1	7/6
RXYSCQ4TMV1B							
RXYSCQ5TMV1B							
RXYSCQ4T7V1B							
RXYSCQ5T7V1B							
RXYSCQ6T7V1B	0,88	0,86	0,80	0,75	0,76	0,82	1,00
RXYSCQ4T7Y1B							
RXYSCQ5T7Y1B							
RXYSCQ6T7Y1B							
RXYSCQ6T7Y1B9							
RXYSCQ8TMY1B	0,95	0,93	0,88	0,84	0,85	0,90	1,00
RXYSCQ10TMY1B	0,95	0,93	0,87	0,79	0,80	0,88	1,00
RXYSCQ12TMY1B	0,95	0,92	0,87	0,75	0,76	0,85	1,00

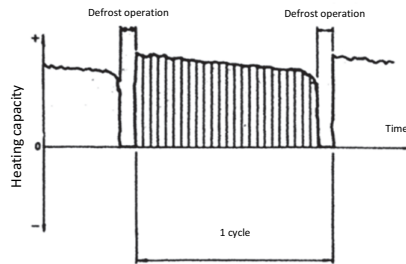

Notes

- (1) The figure shows the integrated heating capacity for a single cycle (from one defrost operation to the next).
- (2) When there is an accumulation of snow against the outdoor unit heat exchanger, there will always be a temporary reduction in capacity depending on the outdoor temperature (°C DB), relative humidity (RH) and the amount of frosting which occurs.

3D094659

5 Capacity tables

5 - 3 Capacity Correction Factor

RXYSCQ-TV1

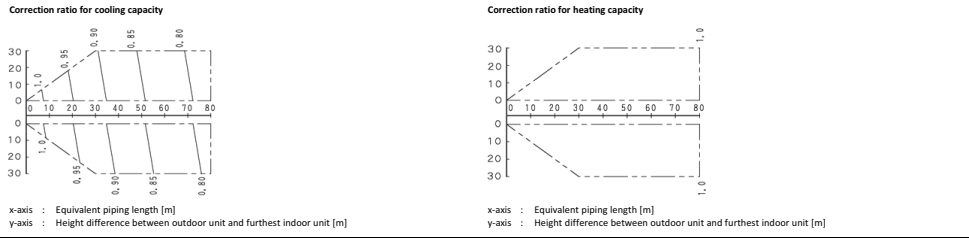

Notes
1. These figures illustrate the capacity correction factor due to the piping length for a standard indoor unit system at maximum load (with the thermostat set to maximum), under standard conditions. Moreover, under partial load conditions, there is only a minor deviation for the capacity correction ratio, as shown in the above figures.

2. With this outdoor unit, the following control is used:
- in case of cooling: constant evaporating pressure control
- in case of heating: constant condensing pressure control

3. **Method of calculating the capacity of the outdoor units.**
The maximum capacity of the system will be either the total capacity of the indoor units or the maximum capacity of the outdoor units as mentioned below, whichever is less.

Indoor connection ratio ≤ 100%.
 Maximum capacity of outdoor units = Capacity of outdoor units from capacity table at 100% connection ratio. × Correction ratio of piping to furthest indoor unit

Indoor connection ratio > 100%.
 Maximum capacity of outdoor units = Capacity of outdoor units from capacity table at installed connection ratio. × Correction ratio of piping to furthest indoor unit

4. When the overall equivalent piping length is 90 m or more, the diameter of the main gas pipes (outdoor unit - branch sections) must be increased. For the new diameters, see below.

Model	Standard liquid side Ø	Increased liquid side Ø	Standard gas side Ø	Increased gas side Ø
RXYSCQ4TMV1B	9,5	Not increased	15,9	19,1
RXYSCQ5TMV1B				

5. Overall equivalent length = Equivalent length of the main pipe × Correction factor + Equivalent length of the branch pipes

Choose the correction factor from the following table.
When calculating the cooling capacity: gas pipe size
When calculating the heating capacity: liquid pipe size

	Standard size	Size increase
Cooling (gas pipe)	1,0	0,5
Heating (liquid pipe)	1,0	0,5

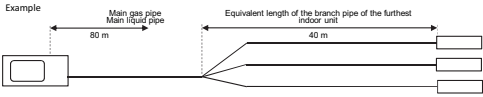

Overall equivalent length

- Cooling mode = 80 m × 0,5 + 40 m = 80 m
- Heating mode = 80 m × 0,5 + 40 m = 80 m

Capacity correction ratio (height difference = 0)

- Cooling mode = 0,78
- Heating mode = 1,0

3D094660

6 Dimensional drawings

6 - 1 Dimensional Drawings

6

RXYSCQ-TV1

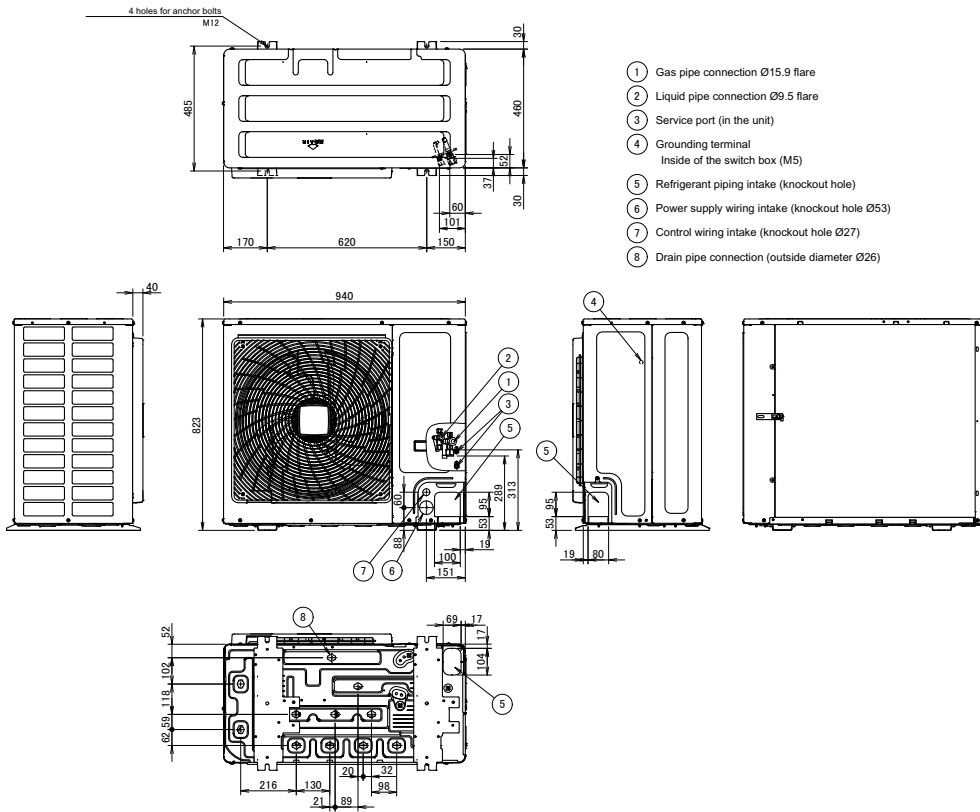

3D098107

7 Centre of gravity

7 - 1 Centre of Gravity

RXYSCQ-TV1

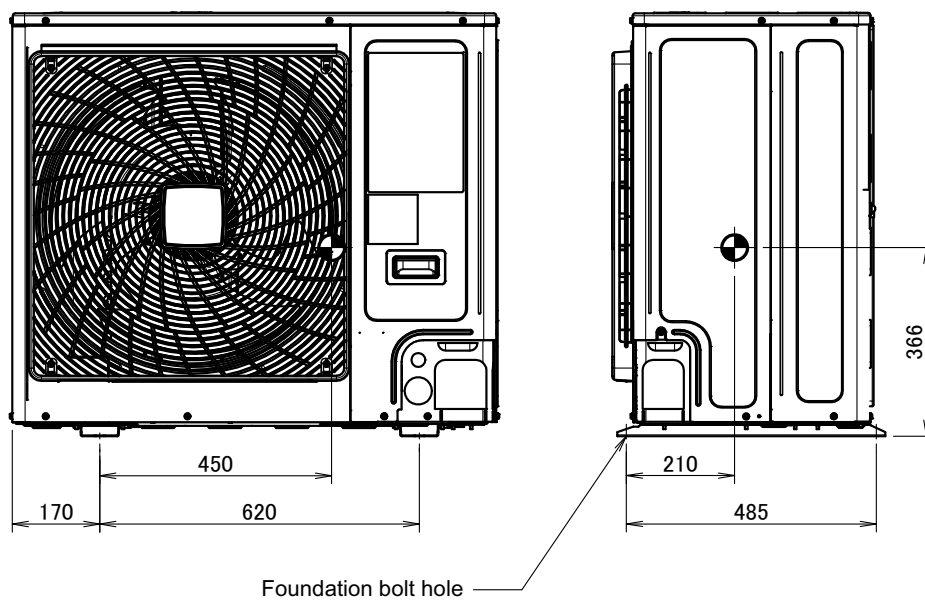

4D098083

8 Piping diagrams

8 - 1 Piping Diagrams

8

RXYSCQ-TV1

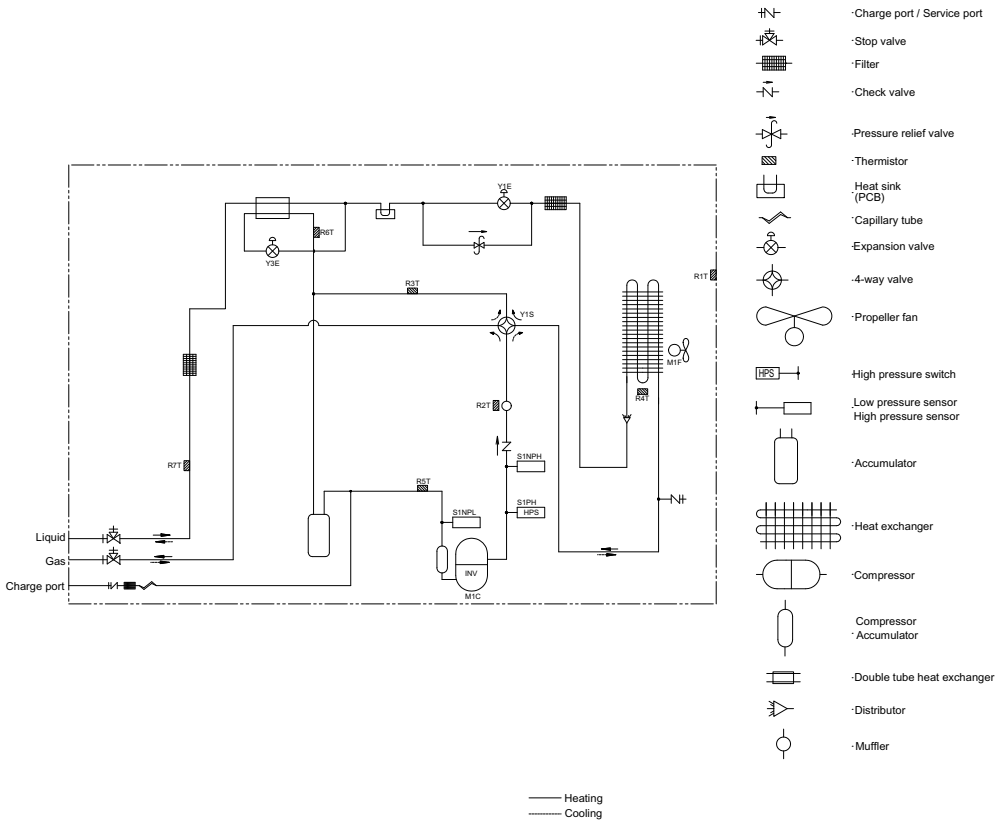

3D097886A

9 Wiring diagrams

9 - 1 Wiring Diagrams - Single Phase

RXYSCQ-TV1

- E1HC : Crankcase heater
- A1P : Printed circuit board (Main)
- A2P : Printed circuit board
- BS1-B5S : Push button switch
- C1 : Capacitor
- DS1 : Dip switch
- F1U : Fuse
- F3U : Fuse (T 6.3A / 250V)
- F4U : Fuse (T 6.3A / 250V)
- F6U : Fuse (T 5A / 250V)
- H1P-H8P : Pilot lamp (service monitor-orange)
[H2P] Prepare, Test ----- Flickering
Malfunction Detection - Light up
- HAP : Pilotlamp (service monitor - green)
- HBP : Pilotlamp (service monitor - green)
- K11M : Magnetic contactor
- K1R : Magnetic relay (Y1S)
- K4R : Magnetic relay (E1HC)
- K1OR : Magnetic relay
- M1C : Motor (compressor)
- M1F : Motor (fan)
- PS : Switching power supply
- R1 : Resistor
- R2 : Resistor
- R1T : Thermistor (Air)
- R2T : Thermistor (Discharge)
- R3T : Thermistor (Suction 1)
- R4T : Thermistor (Heat exchanger)
- R5T : Thermistor (Suction 2)
- R6T : Thermistor (Subcooling H,Ex)
- R7T : Thermistor (Liquid pipe)
- F1NTH : Thermistor (Fin)
- S1NPH : Pressure sensor(High)
- S1NPL : Pressure sensor(low)
- S1PH : High pressure switch
- V1R : IGBT power module
- V2R : Diode module
- V1T-V3T : IGBT
- V1D-V3D : Diode
- L1R-L3R : Reactor
- X1M : Terminal strip
- X2M : Terminal strip
- Y1E : Electronic expansion valve
- Y3E : Electronic expansion valve
- Y1S : Solenoid valve (4 way valve)
- Z1C-Z7C : Noise filter (ferrite core)
- Z1F-Z5F : Noise filter
- X37A : Connector

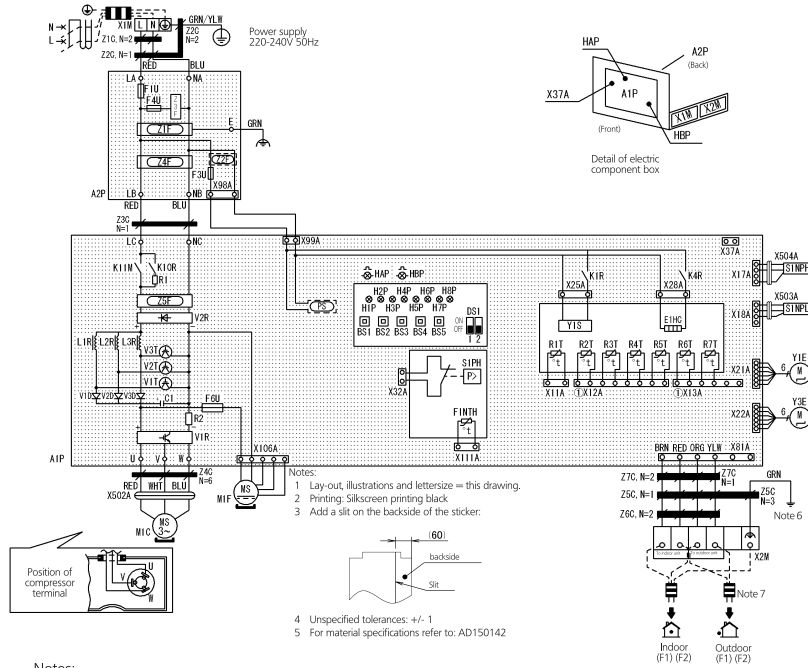

- Notes:
1. This wiring diagram only applies to the outdoor unit.
 2. [Symbol] : Field wiring [Symbol] : Terminal block, [Symbol] : Connector, [Symbol] : Movable connector, [Symbol] : Fixed connector, [Symbol] : Terminal, [Symbol] : Protective earth (screw), [Symbol] : Noiseless earth
 3. Refer to the installation manual on how to use BS1 - B5S and DS1, DS2 switch.
 4. When operating, do not short circuit for protection device. (S1PH)
 5. Colours: BLK: Black, RED: Red, BLU: Blue, WHT: White, GRN: Green, BRN: Brown, YLW: Yellow
 6. Refer to the installation manual for connection wiring to indoor-outdoor transmission F1 - F2.
 7. When using the central control system, connect outdoor-outdoor transmission F1-F2.

2D0943433E

10 External connection diagrams

10 - 1 External Connection Diagrams

RXYSCQ-TV1

External connection diagram

VRV indoor unit

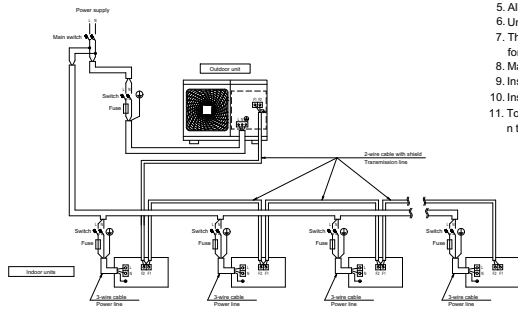

Notes

1. All wiring, components and materials to be procured on-site must comply with the applicable legislation.
2. Use copper conductors only
3. For more details, refer to the wiring diagram of the unit.
4. Install a circuit breaker for safety.
5. All field wiring and components must be provided by an authorised electrician.
6. Unit has to be grounded in compliance with the applicable legislation.
7. The wiring shown is a general points-of-connection guide and is not intended to include all details for a specific installation.
8. Make sure to install the switch and the fuse to the power line of each equipment.
9. Install a main to switch to (if necessary) immediately interrupt all the system's power sources.
10. Install an earth leakage circuit breaker.
11. To ensure proper earthing, connect the shields of the incoming and outgoing transmission wiring of each indoor unit (or each BP box, depending on the system layout) to each other.

BP box + RA/SA indoor unit

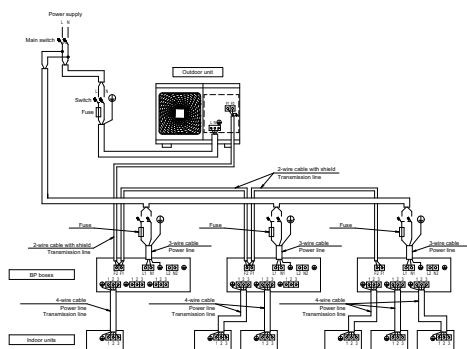

Power source is supplied to each BP box individually.

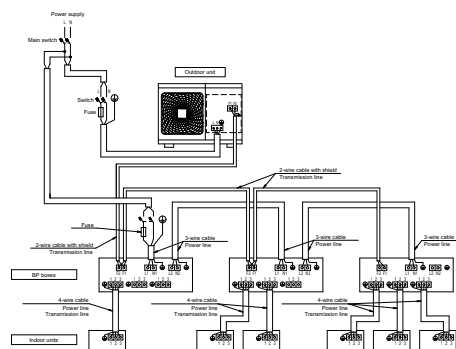

Power source is connected in series between the units.

ID094668

11 Sound data

11 - 1 Sound Power Spectrum

RXYSCQ4TV1

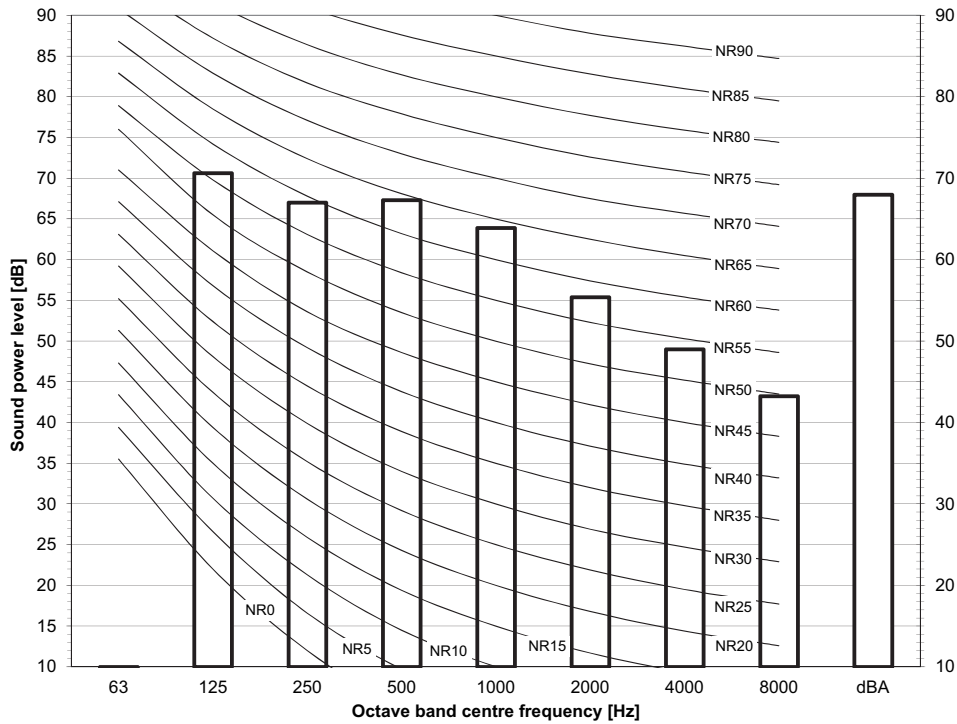

Notes
 - dBA = A-weighted sound power level (A scale according to IEC).
 - Reference acoustic intensity 0dB = 10E-6μW/m²
 - Measured according to ISO 3744

3D098238

RXYSCQ5TV1

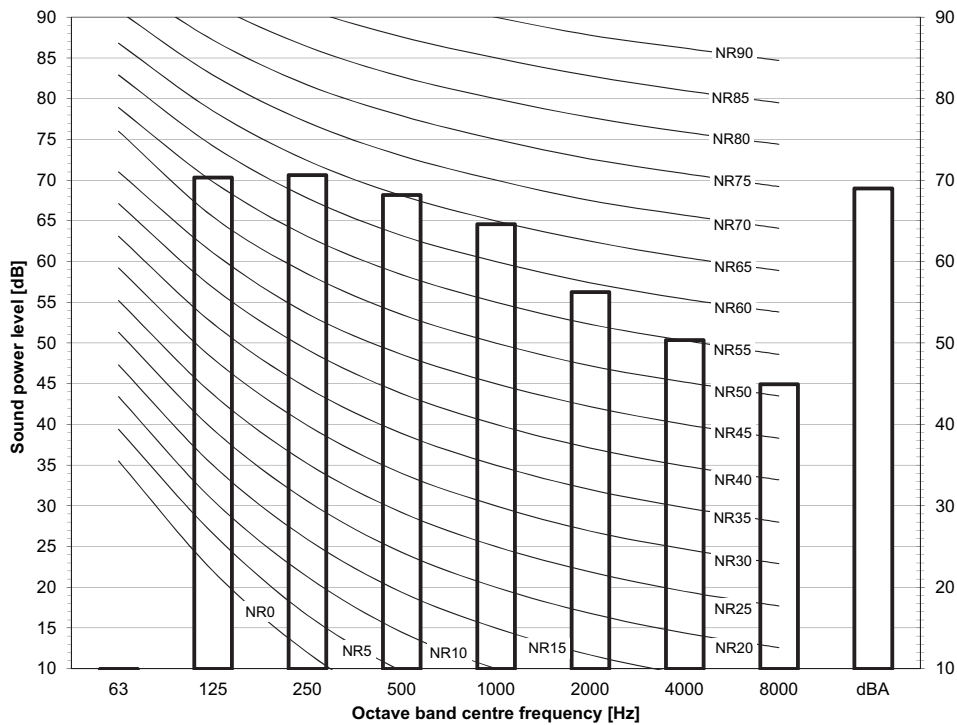

Notes
 - dBA = A-weighted sound power level (A scale according to IEC).
 - Reference acoustic intensity 0dB = 10E-6μW/m²
 - Measured according to ISO 3744

3D098239

11 Sound data

11 - 2 Sound Pressure Spectrum

11

RXYSCQ4TV1

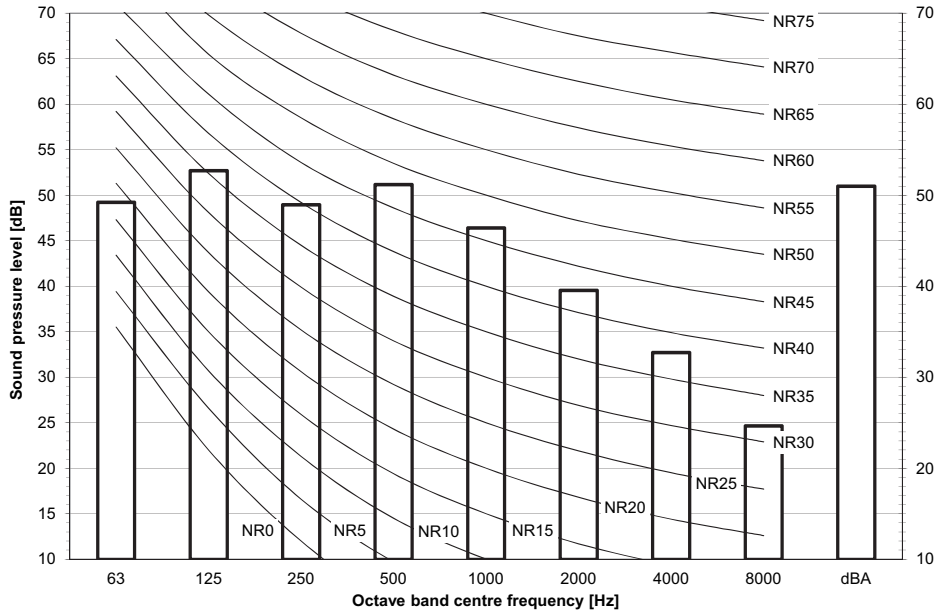

- Notes**
- Data is valid at free field condition.
 - Data is valid at nominal operation condition.
 - dBA = A-weighted sound pressure level (A scale according to IEC).
 - Reference acoustic pressure 0 dB = 20 µPa

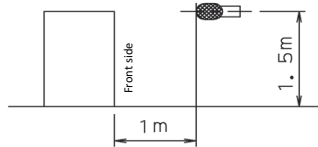

3D098243

RXYSCQ5TV1

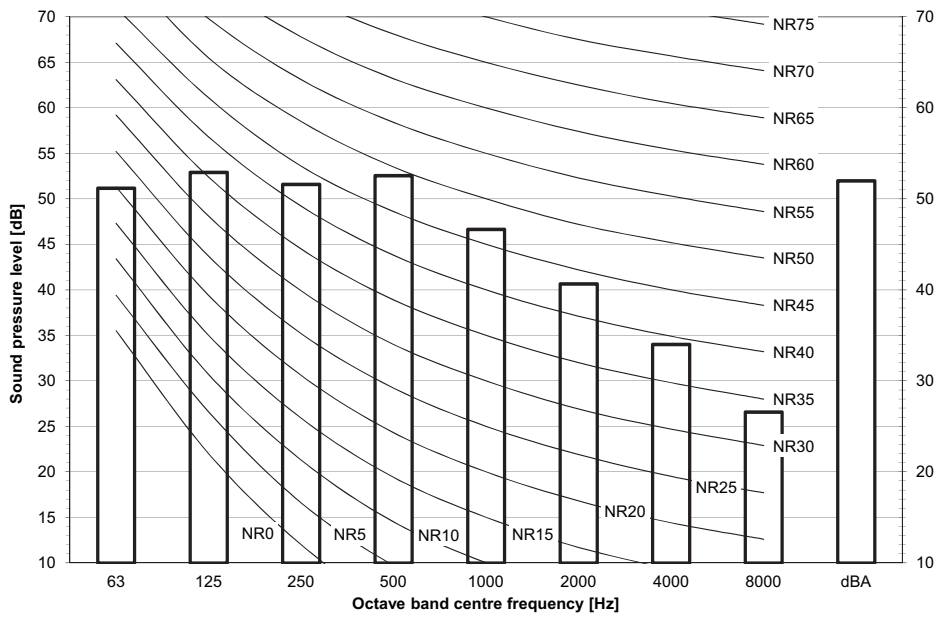

- Notes**
- Data is valid at free field condition.
 - Data is valid at nominal operation condition.
 - dBA = A-weighted sound pressure level (A scale according to IEC).
 - Reference acoustic pressure 0 dB = 20 µPa

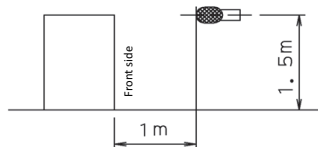

3D098244

12 Installation

12 - 1 Installation Method

RXYSCQ-TV1

Required installation space

The unit of the values is mm.

(A) When there are obstacles on suction sides.

• No obstacle above

- ① Stand-alone installation
 - Obstacle on the suction side only

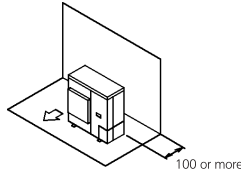

- Obstacle on both sides

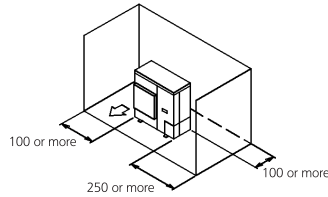

- ② Series installation (2 or more)
 - Obstacle on both sides

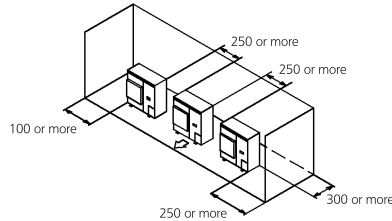

• Obstacle above, too.

- ① Stand-alone installation
 - Obstacle on the suction side, too

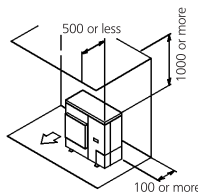

- Obstacle on the suction side and both sides

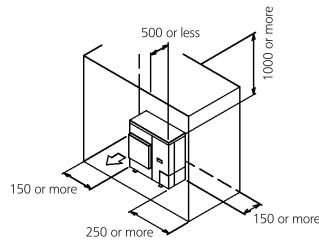

- ② Series installation (2 or more)
 - Obstacle on the suction side and both sides

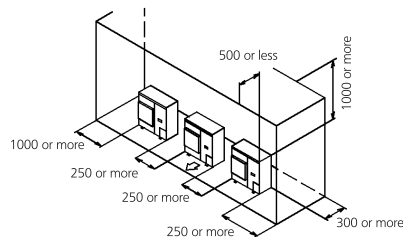

(B) When there are obstacles on discharge sides.

• No obstacle above

- ① Stand-alone installation

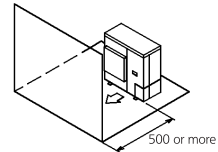

- ② Series installation (2 or more)

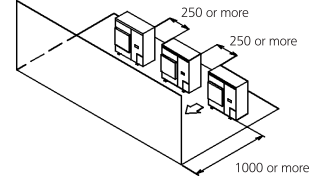

• Obstacle above, too

- ① Stand-alone installation

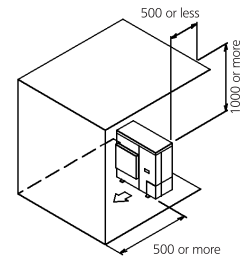

- ② Series installation (2 or more)

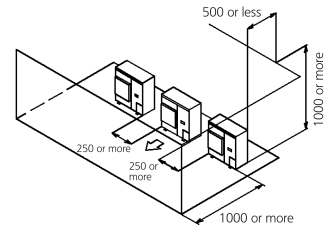

(C) When there are obstacles on both suction and discharge sides.:

Pattern 1

When the obstacles on the discharge side is higher than the unit.
(There is no height limit for obstructions on the intake side.)

• No obstacle above

- ① Stand-alone installation

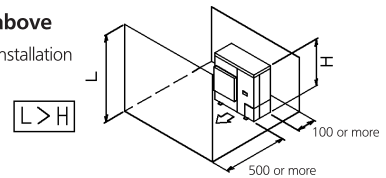

- ② Series installation (2 or more)

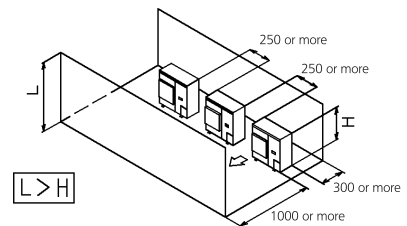

3D089310A

12 Installation

12 - 1 Installation Method

RXYSCQ-TV1

● Obstacle above, too

① Stand-alone installation

The relations between H, A and L are as follows.

	L	A
$L \leq H$	$0 < L \leq 1/2 H$	750
	$1/2 H < L \leq H$	1000
$H < L$	Set the stand as: $L \leq H$	

Close the bottom of the installation frame to prevent the discharged air from being bypassed.

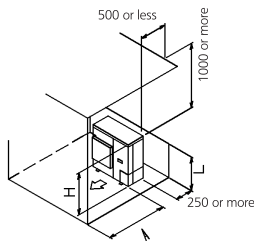

② Series installation (2 or more)

The relations between H, A and L are as follows.

	L	A
$L \leq H$	$0 < L \leq 1/2 H$	1000
	$1/2 H < L \leq H$	1250
$H < L$	Set the stand as: $L \leq H$	

Close the bottom of the installation frame to prevent the discharged air from being bypassed. Only two units can be installed for this series.

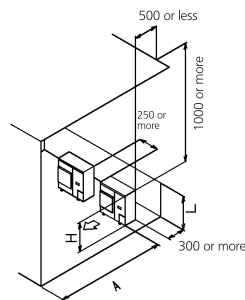

Pattern 2

When the obstacle on the discharge side is lower than the unit:
(There is no height limit for obstructions on the intake side.)

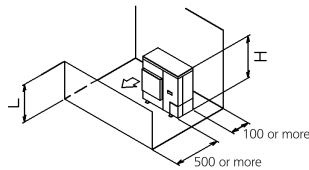

① Stand-alone installation

$L > H$

② Series installation (2 or more)

The relations between H, A and L are as follows.

	L	A
$0 < L \leq 1/2 H$		250
$1/2 H < L \leq H$		300

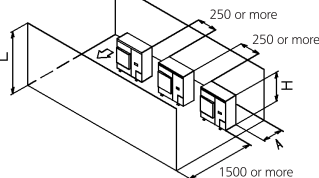

● Obstacle above, too

① Stand-alone installation

The relations between H, A and L are as follows.

	L	A
$L \leq H$	$0 < L \leq 1/2 H$	100
	$1/2 H < L \leq H$	200
$H < L$	Set the stand as: $L \leq H$	

Close the bottom of the installation frame to prevent the discharged air from being bypassed.

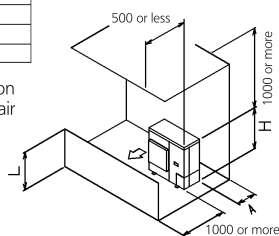

② Series installation

The relations between H, A and L are as follows.

	L	A
$L \leq H$	$0 < L \leq 1/2 H$	250
	$1/2 H < L \leq H$	300
$H < L$	Set the stand as: $L \leq H$	

Close the bottom of the installation frame to prevent the discharged air from being bypassed. Only two units can be installed for this series.

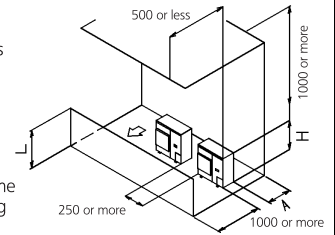

(D) Double-decker installation

① Obstacle on the discharge side.

Close the gap Z (the gap between the upper and lower outdoor units) to prevent the discharged air from being bypassed. Do not stack more than two unit.

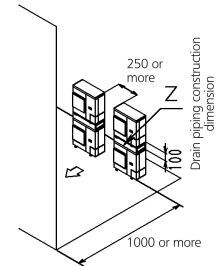

② Obstacle on the suction side.

Close the gap Z (the gap between the upper and lower outdoor units) to prevent the discharged air from being bypassed. Do not stack more than two unit.

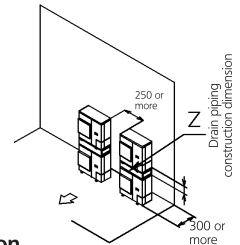

(E) Multiple rows of series installation (on the rooftop, etc.)

① One row of stand-alone installation

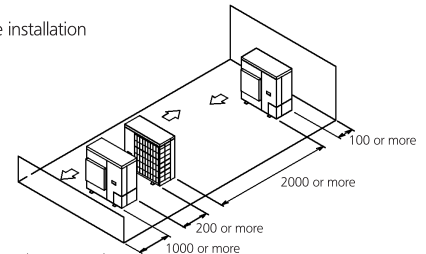

② Rows of series installation (2 or more)

The relations between H, A and L are as follows.

	L	A
$L \leq H$	$0 < L \leq 1/2 H$	250
	$1/2 H < L \leq H$	300
$H < L$	Can not be installed	

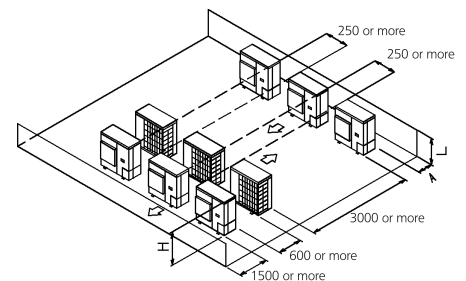

12 Installation

12 - 2 Refrigerant Pipe Selection

RXYSCQ-TV1
 RXYSQ-TV1
 RXYSQ-TY1

For the reference drawing, see page -2/3-.

		Maximum piping length		Maximum height difference		Total piping length
		Longest pipe (A+B,D+E,H) Actual / (Equivalent)	After first branch (B,D+E,H) Actual	Indoor-to-outdoor (H1) Outdoor above indoor / (indoor above outdoor)	Indoor-to-indoor (H2)	
Standard -VRV DX- indoor units only	RXYSCQ4~5TMV1B	70/(90)m	40m	30/(30)m	15m	300m
	RXYSQ4~6T7(V/Y)1B	120/(150)m	40m	50/(40)m	15m	300m
	RXYSQ8TMY1B	100/(130)m	40m	50/(40)m	15m	300m
	RXYSQ10~12TMY1B	120/(150)m	40m	50/(40)m	15m	300m
-RA- connection	RXYSCQ4~5TMV1B	35/(45)m	40m	30/(30)m	15m	140m
	RXYSQ4~6T7(V/Y)1B	65/(85)m	40m	30/(30)m	15m	140m
	RXYSQ8TMY1B	80/(100)m	40m	30/(30)m	15m	140m
	RXYSQ10~12TMY1B	80/(100)m	40m	30/(30)m	15m	140m
Air handling unit (-AHU-) connection	Pair	50/(55)m (1)	-	40/(40)m	-	-
	Multi	(2) 50/(55)m (1)	40m	40/(40)m	15m	300m
	Mix	(3) 50/(55)m (1)	40m	40/(40)m	15m	300m

- Notes**
- The allowable minimum length is 5- m.
 - Multiple air handling units (-AHU-)(EKEVX + EKEQ; kits).
 - Mix of air handling units (-AHU-) and -VRV DX- indoor units.

3D097984

RXYSCQ-TV1
 RXYSQ-TV1
 RXYSQ-TY1

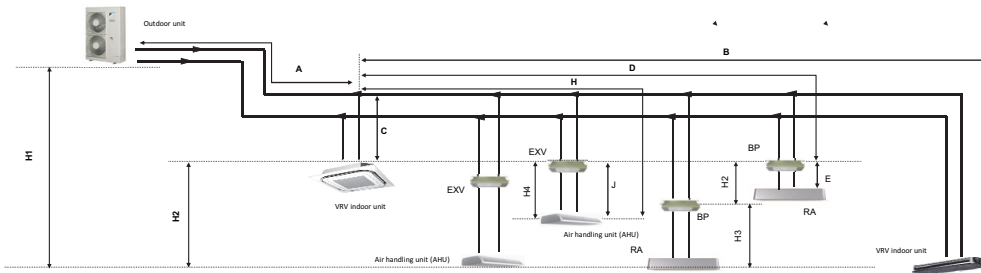

- Notes**
- Schematic indication illustrations may differ from the actual appearance of the unit.
 - This is only to illustrate piping length limitations. Refer to combination table -3D097983- for details about the allowed combinations.

		Allowed piping length		Maximum height difference	
		-BP- to -RA- (E)	-EXV- to -AHU- (J)	-BP- to -RA- (H3)	-EXV- to -AHU- (H4)
-RA- connection		2~15m	-	5m	-
Air handling unit (AHU) Connection	Pair	-	≤5m	-	5m
	Multi	(1) -	≤5m	-	5m
	Mix	(2) -	≤5m	-	5m

- Notes**
- Multiple air handling units (-AHU-)(EKEVX + EKEQ; kits).
 - Mix of air handling units (-AHU-) and -VRV DX- indoor units.

3D097984

12 Installation

12 - 2 Refrigerant Pipe Selection

12

RXYSCQ-TV1

RXYSQ-TV1

RXYSQ-TY1

System pattern Allowed connection ratio (CR) Other combinations are not allowed.	Total		Allowed capacity		
	Capacity	Maximum allowed amount of connectable indoor units (VRV, RA, AHU) Excluding -BP- units and including -EXV- kits.	VRV DX indoor unit	-RA DX- indoor unit	Air handling unit (AHU)
-VRV DX- indoor units only	50~130%	Maximum -64-	50~130%	-	-
-RA DX- indoor units only	80~130%	Maximum -32- (1)	-	80~130%	-
-VRV DX- indoor unit + -AHU- Mix	50~110% (3)	Maximum -64- (2)	50~110%	-	0~110%
-AHU- only Pair + multi (4)	90~110% (3)	Maximum -64- (2)	-	-	90~110%

Notes

1. There is no restriction on the number of connectable -BP- boxes.
2. -EKEXV- kits are also considered indoor units.
3. Restrictions regarding the air handling unit capacity
4. Pair AHU = system with 1 air handling unit connected to one outdoor unit
Multi AHU = system with multiple air handling units connected to one outdoor unit

About ventilation applications

- I. -FXMQ_MF- units are considered air handling units, following air handling unit limitations.
 - Maximum connection ratio when combined with -VRV DX- indoor units: -CR ≤ 30%-
 - Maximum connection ratio when only air handling units are connected: -CR ≤ 100%-
 - Minimum connection ratio when only -FXMQ_MF- units are connected: -CR ≥ 50%-
 For information on the operation range, refer to the documentation of the -FXMQ_MF- unit.
- II. -Biddle- air curtains are considered air handling units, following air handling unit limitations:
For information on the operation range, refer to the documentation of the -Biddle- unit.
- III. -EKEXV + EKEQ- units combined with an air handling unit are considered air handling units, following air handling unit limitations.
For information on the operation range, refer to the documentation of the -EKEXV-EKEQ- unit.
- IV. -VKM- units are considered to be regular -VRV DX- indoor units.
For information on the operation range, refer to the documentation of the -VKM- unit.
- V. Because there is no refrigerant connection with the outdoor unit (only communication F1/F2), -VAM- units do not have connection limitations.
However, since there is communication via F1/F2, count them as regular indoor unit when calculating the maximum allowed number of connectable indoor units.

3D097984

13 Operation range

13 - 1 Operation Range

RXYSCQ-TV1
 RXYSQ-TV1
 RXYSQ-6TY1

- Notes
1. These figures assume the following operation conditions
 Indoor and outdoor units
 Equivalent piping length: 5m
 Level difference: 0m
 2. Depending on operation and installation conditions, the indoor unit can change over to freeze-up operation (indoor de-icing).
 3. To reduce the freeze-up operation (indoor de-icing) frequency, it is recommended to install the outdoor unit in a location not exposed to wind.
 4. Operation range is valid in case direct expansion indoor units are used.
 If other indoor units are used, refer to the documentation of the respective indoor units.
 5. If the unit is selected to operate at ambient temperatures -5°C for 5 days or more, with relative humidity levels >95%, it is recommended to apply a Daikin range specifically designed for such application.
 For more information, contact your dealer.

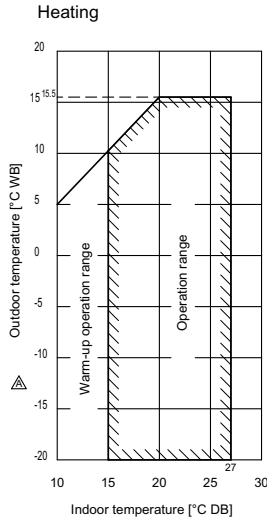
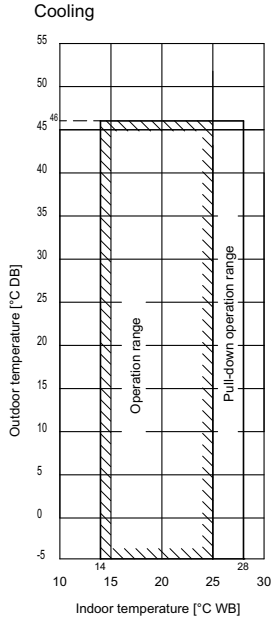

3D094664A



Daikin Europe N.V. Naamloze Vennootschap - Zandvoordestraat 300, B-8400 Oostende - Belgium - www.daikin.eu - BE 0412 120 336 - RPR Oostende

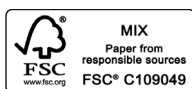
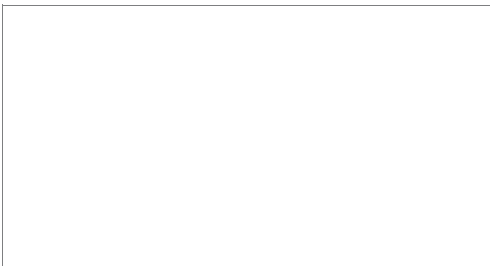

EEDEN XXX-06/16



Daikin Europe N.V. participates in the Eurovent Certification programme for Liquid Chilling Packages (LCP), Air handling units (AHU), Fan coil units (FCU) and variable refrigerant flow systems (VRF) Check ongoing validity of certificate online: www.eurovent-certification.com or using: www.certiflash.com



The present leaflet is drawn up by way of information only and does not constitute an offer binding upon Daikin Europe N.V.. Daikin Europe N.V. has compiled the content of this leaflet to the best of its knowledge. No express or implied warranty is given for the completeness, accuracy, reliability or fitness for particular purpose of its content and the products and services presented therein. Specifications are subject to change without prior notice. Daikin Europe N.V. explicitly rejects any liability for any direct or indirect damage, in the broadest sense, arising from or related to the use and/or interpretation of this leaflet. All content is copyrighted by Daikin Europe N.V.